

# INSTRUCTION MANUAL

# TECO INVERTER

## 200V Class

1/3 phase 0.75~2.2KW  
1~3HP

3 phase 3.7~75 KW  
5~100HP

## 400V Class

3 phase 0.75~160KW  
1~215HP



# TECO INVERTER

# A510 Series

# Contents

<b>Chapter 0</b> .....	<b>0-1</b>
0.1 Foreword.....	0-1
<b>Chapter 1 Safety precautions</b> .....	<b>1-1</b>
1.1 Before supplying power.....	1-1
1.2 Wiring.....	1-2
1.3 Before operation.....	1-2
1.4 Parameters setting.....	1-3
1.5 Operation.....	1-3
1.6 Maintenance, Inspection and Replacement.....	1-5
<b>Chapter 2 Model Description</b> .....	<b>2-1</b>
2.1 Nameplate Data.....	2-1
2.2 Model Designation.....	2-1
<b>Chapter 3 Ambient Environment And Installation</b> .....	<b>3-1</b>
3.1 Environment.....	3-1
3.2 Installation.....	3-3
3.2.1 Installation space.....	3-3
3.2.2 External view of the product and warning label information.....	3-4
3.2.3 Product Dismounting.....	3-7
3.2.3.1 Standard type.....	3-7
3.2.3.2 Built-in filter type (440V 1 ~60HP).....	3-11
3.3 Wiring the peripheral devices of the inverter and related cautions.....	3-13
3.4 Terminal Description.....	3-17
3.5 Internal wiring diagram of main circuit.....	3-22
3.6 Instrument for main circuit wiring and caution.....	3-23
3.7 Inverter Specifications.....	3-28
3.8 Overall Dimension drawing.....	3-36
3.8.1 Standard Model.....	3-36
3.8.2 Built-in filter model (440V 1~60HP).....	3-40
<b>Chapter 4 Software Index</b> .....	<b>4-1</b>
4.1 Keypad Description.....	4-1
4.1.1 Panel Functions.....	4-1
4.1.2 Display Description.....	4-2
4.1.3 LED Functional structure of LED seven-segment display.....	4-4
4.1.4 Example of keypad operation.....	4-6
4.1.5 Operation Control.....	4-8
4.2 Parameters list.....	4-9
4.3 Description of Parameter Functions.....	4-52
4.4 Description of Built-in PLC Function.....	4-210
4.4.1 Basic command.....	4-210

4.4.2 Basic command function .....	4-211
4.4.3 Application command.....	4-212
<b>Chapter 5 Trouble Diagnosis and shooting .....</b>	<b>5-1</b>
5.1 General .....	5-1
5.2 Fault detection function .....	5-1
5.3 Warning / self-diagnosis detection function .....	5-5
5.4 Auto-tuning error .....	5-11
5.5 PM motor auto-tuning error .....	5-12
<b>Chapter 6 Peripheral devices and option.....</b>	<b>6-1</b>
6.1 List of braking resistor and braking detection module .....	6-1
6.2 AC reactor.....	6-3
6.3 Harmonic Filter.....	6-4
6.4 Noise filter .....	6-7
6.5 Output filter specification.....	6-10
6.6 Input power side Fuse specification .....	6-11
6.7 PG speed feedback card.....	6-12
6.8 Other .....	6-14
6.9 Communication Interface Module (in development).....	6-16
<b>Appendix.....</b>	<b>Appendix-1</b>

# Chapter 0 Foreword

## 0.1 Foreword

To make full use of the inverter functions and ensure your safety, please read this manual carefully. In case of any problems found in use, please contact local dealer or the company's technical staff, our professionals will be happy to help you.

### ※ Caution on use

Inverter is a precision electronic product. For protecting your life and property, this manual has been marked with "Warning", "Caution" to remind you of the safety precaution issues in handling, installation, use and inspection. Please comply with it.

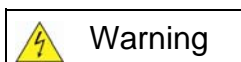

Warning

Inproper operation might cause serious personal injury.

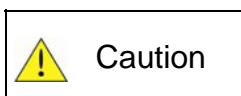

Caution

Inproper operation might cause damage of inverter or mechanical system.



Warning

- Avoid electrical shock! Since the DC capacitors inside the inverter discharges completely in 5 minutes after the power supply is removed, please disassemble or inspect it after 5 minutes when the power supply is removed.
- Wiring is not allowed when the power is supplied. Do not inspect the circuit board when the inverter is in operation.
- Do not assembly/disassemble or replace the internal wiring or circuit and parts of the inverter by yourself.
- Make sure the earth terminal of the inverter is properly grounding.



Caution

- Do not carry out the dielectric voltage withstand test on the internal parts of the inverter because they are easily damaged by high voltage.
- Connecting U/T1, V/T2 and W/T3 of inverter terminal to AC power is strictly prohibited.
- CMOS integrated circuits of inverter circuit board are easily affected and damaged by static electricity. Do not touch the circuit board.

# Chapter 1 Safety Precautions

## 1.1 Before supplying power



### Warning

- The main circuit must be properly wiring. Single phase( R/L1, S/L2)/3-phase(R/L1, S/L2, T/L3) are the input terminal of the power, which must not be mixed with U/T1,V/T2 and W/T3 on use. In case of mixed use, supplying power will damage the inverter.



### Caution

- The power voltage must be the same as the input voltage of the inverter.
- When handling the inverter, do not draw the front cover directly. It is suggested to handle the inverter body so as to prevent the front cover breaks off, avoiding the inverter falling and causing injury or inverter damage.
- Please mount the inverter on noncombustible materials such as metal. Mounting on or near the flammable materials is not allowed in case fire happened.
- If several inverters are mounted on a single control panel, the extra cooling fan shall be added, so as to make the panel temperature below 40 °C and to prevent overheating or fire.
- Please firstly turn off the power before disassemble or assemble the operator. Fix the operator according to the indicating diagram to avoid operation failure or no display due to improper operation.



### Warning

- This product has passed the application level at IEC 61800-3 restricted areas. When the product is used in some environments, there might be electromagnetic interference. Therefore, appropriate test is recommended to be carried out before use and grounding must be well done.



### Caution

- Installation and use of the product must be conducted by a qualified professional electrician.
- The product installation must be applied by the means of fixed wiring.

## 1.2 Wiring



### Warning

- Always turn OFF the input power supply before inverter installation or wiring terminals, so as to avoid electric shock or fire.
- Wiring must be performed by an authorized person qualified in electrical work, to avoid electric shock or fire.
- Make sure the grounding terminal is well grounded. (220 V class: Grounding impedance shall be less than 100Ω, 460 V class: Grounding impedance shall be less than 10Ω)
- Always test the operation of any emergency stop circuits after wiring. (Wiring is the responsibility of the user.)
- Never touch the input/output lines directly with your hands or allow any line to contact the Inverter case. Never short the circuits.
- Do not carry out the dielectric voltage withstand test on the inverter, which will cause the semiconductor parts damage easily.



### Caution

- Make sure the input power meets that of the inverter, in order to avoid injury or fire.
- Please connect the braking resistor and braking unit according to the related wiring diagram in case fire occurred.
- Please fasten the terminal screws based on specified torque so as to avoid fire.
- Do not connect the input power supply line to the output terminal of the inverter.
- Do not connect the magnetic contactor and solenoid switch contacts to the output terminal.
- Do not connect the phase advancing capacitor or LC / RC filter to the output circuit.
- Ensure the interference generated by the inverter and motor will not affect peripheral sensors or devices.

## 1.3 Before operation



### Warning

- Make sure the inverter capacity is the same as the capacity set by inverter's function parameters 13—00 before supplying power.
- If the line length between the inverter and the motor exceeds 25 meters, it needs to reduce the carrier frequency (11-01) or additionally equip a output filter to reduce the over-voltage or oscillation at the load end, so as to avoid motor damage.

## 1.4 Parameters setting



### Caution

- When carry out the rotatable automatic tuning, do not connect the motor to the load (mechanical device).
- When carry out the rotatable automatic tuning and the motor will rotate, make sure around space of the motor is enough in order to avoid danger.

## 1.5 Operation



### Warning

- Make sure the front external cover is completely installed in prior to turn on the power.
- Do not connect or disconnect the motor unit in operation, otherwise the inverter will cause the inverter to trip because of over-current. The severe case will cause the main circuit damage of the inverter.
- When the reset function is in operation, keep away from the machine. The machine will restart after the fault is cleared.
- Do not operate the machine with wet hands.
- It provides a independent emergency stop switch. This switch will be enabled when the parameter is being set (see 11-55).
- It provides an independent external hardware emergency switch, which emergently shuts down the inverter output in the case of danger.
- Make sure the operation order is closed before reset warning.
- If choose to automatically restart after power recovery (07-00), the inverter will start automatically after power is restored.
- Before automatic tuning, make sure the conditions of surrounding systems and mechanical devices to ensure the safety of personnel.
- Never touch related terminals regardless of inverter in operation or in stop states to avoid any danger.
- After the power is cut off, the fan might continue to rotate for some time.



### **Caution**

- Do not touch the heating elements such as heat sink, braking resistor, etc. 
- The inverter enables easily the motor rotates from low speed to high speed. Please make sure the allowable range of the motor and the machine.
- When the product is supported by the use of the braking module, please pay attention to related settings for operation.
- Inspecting the circuit board signal should be avoided when the inverter is in operation.



### **Warning**

- Avoid electrical shock! The internal DC capacitor of the inverter discharges in 5 minutes after the power is cut off. Therefore, carry out disassembly/assembly or inspection after 5 minutes when the discharge completes.



## 1.6 Maintenance, Inspection and Replacement



### Warning

- Before the maintenance and inspection, make sure the power is cut off and the indicator light of the power is off (make sure the DC voltage does not exceed 25 v).
- Since there are high voltage terminals in the inverter, do not touch these terminals randomly.
- In the case of power on, be sure the protection cover is installed. In addition, when the protection cover is disassembled, be sure to cut off the power by the circuit breaker.
- Only the designated professional can carry out the maintenance or parts replacement.



### Caution

- The ambient temperature of the inverter should be from  $-10^{\circ}\text{C}$  to  $+40(60)^{\circ}\text{C}$  95%RH and the inverter shall be used in the non-condensing environment, free from water dropping and metal dust in surrounding.

### Disposal caution for the inverter



### Caution

Treat as industrial waste when disposing of inverter and pay attention to the following items:

- Burning electrolytic capacitors of the inverter main circuit and printed circuit board might cause explosion;
- Burning the plastic parts such as inverter shell will produce toxic gases.

# Chapter 2 Model Description

## A510 Series

### 2.1 Nameplate Data:

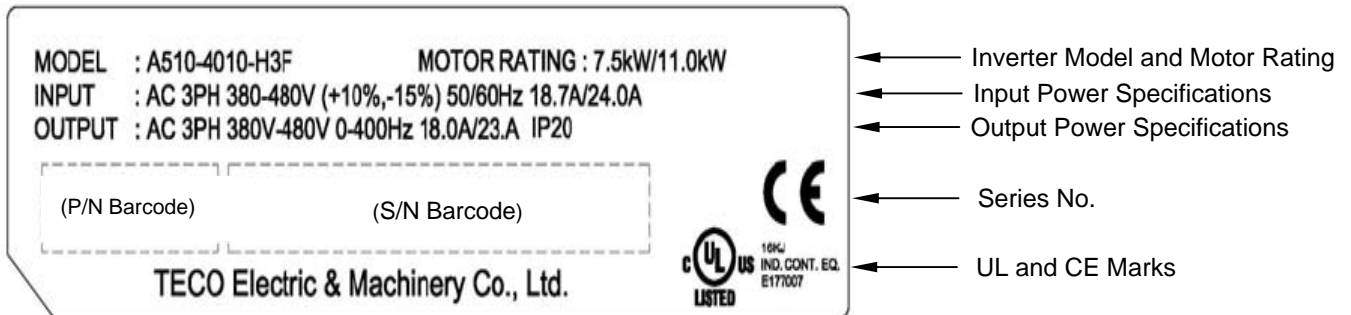

### 2.2 Model Designation:

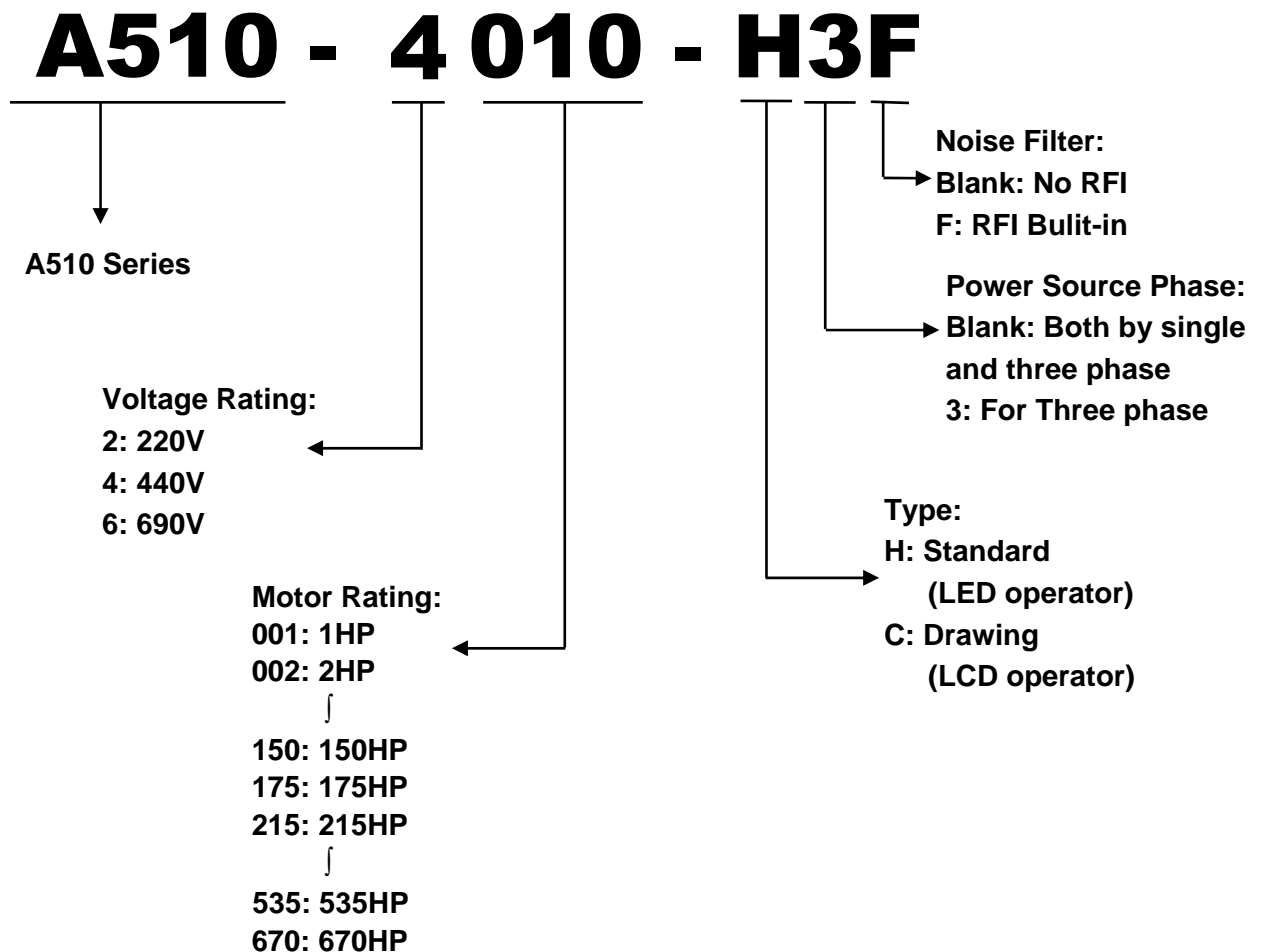

**Model list:**

Inverter model (Model for standard products)	Voltage(Vac)	Applied frequency (Hz)	Horse Power (Hp)	Applied Motor (KW)	Filter Built-in	
					with	without
A510-2001-H	1ph/3ph, 200~240V +10%/-15%	50/60Hz	1	0.75		⊙
A510-2002-H			2	1.5		⊙
A510-2003-H			3	2.2		⊙
A510-2005-H3	3ph, 200~240V +10%/-15%		5	3.7		⊙
A510-2008-H3			7.5	5.5		⊙
A510-2010-H3			10	7.5		⊙
A510-2015-H3			15	11		⊙
A510-2020-H3			20	15		⊙
A510-2025-H3			25	18.5		⊙
A510-2030-H3			30	22		⊙
A510-2040-H3			40	30		⊙
A510-2050-H3			50	37		⊙
A510-2060-H3			60	45		⊙
A510-2075-H3			75	55		⊙
A510-2100-H3			100	75		⊙
A510-2125-H3			125	94		⊙
A510-2150-H3			150	112		⊙
A510-4001-H3	3ph, 380~480V +10%/-15%	1	0.75		⊙	
A510-4001-H3F		1	0.75	⊙		
A510-4002-H3		2	1.5		⊙	
A510-4002-H3F		2	1.5	⊙		
A510-4003-H3		3	2.2		⊙	
A510-4003-H3F		3	2.2	⊙		
A510-4005-H3		5	3.7		⊙	
A510-4005-H3F		5	3.7	⊙		
A510-4008-H3		7.5	5.5		⊙	
A510-4008-H3F		7.5	5.5	⊙		
A510-4010-H3		10	7.5		⊙	
A510-4010-H3F		10	7.5	⊙		
A510-4015-H3		15	11		⊙	
A510-4015-H3F		15	11	⊙		
A510-4020-H3		20	15		⊙	
A510-4020-H3F		20	15	⊙		
A510-4025-H3		25	18.5		⊙	
A510-4025-H3F		25	18.5	⊙		
A510-4030-H3		30	22		⊙	
A510-4030-H3F		30	22	⊙		
A510-4040-H3		40	30		⊙	
A510-4040-H3F	40	30	⊙			
A510-4050-H3	50	37		⊙		
A510-4050-H3F	50	37	⊙			

<b>A510-4060-H3</b>			<b>60</b>	<b>45</b>		◎
<b>A510-4060-H3F</b>			<b>60</b>	<b>45</b>	◎	
<b>A510-4075-H3</b>			<b>75</b>	<b>55</b>		◎
<b>A510-4100-H3</b>			<b>100</b>	<b>75</b>		◎
<b>A510-4125-H3</b>			<b>125</b>	<b>94</b>		◎
<b>A510-4150-H3</b>			<b>150</b>	<b>112</b>		◎
<b>A510-4175-H3</b>			<b>175</b>	<b>130</b>		◎
<b>A510-4215-H3</b>			<b>215</b>	<b>160</b>		◎
<b>A510-4250-H3</b>			<b>250</b>	<b>185</b>		◎
<b>A510-4300-H3</b>			<b>300</b>	<b>220</b>		◎
<b>A510-4375-H3</b>			<b>375</b>	<b>280</b>		◎

.The short-circuit capacity of the inverter is 5000A/240V or below 5000A/480V, 220V for model of 200~240V; 440V for model of 380~480V; 690V for model of 575~690V  
.220V 125HP (94KW) and 440V 250HP (185KW) or higher are being developed.  
.690V is being developed.

# Chapter 3 Ambient Environment And Installation

## 3.1 Environment

The installing environment of the inverter directly affects its functions and the service life. Therefore, the installation environment must meet the following conditions:

Protection	
Protection Class	IP20/NEMA 1, IP00
Applicable environment	
Operating Temperature	-10~40°C (With the dust-protection cover open, the applicable operation temperature (-10~50°C)) (full load) can reach maximum of 60°C. But it is required to de-rating 2% of the rated current for increasing one degree. For multiple inverters installed side by side in the plate, please pay attention to the placement to facilitate heat radiating.
Storage Temperature	-20~70°C
Humidity	RH should be 5% to 95%, free of condensation or water droplets. (Follow IEC60068-2-78 standard)
Shock	Maximum acceleration: 1.2G (12m/s <sup>2</sup> ), from 49.84 to 150 Hz Displacement amplitude : 0.3mm (peak value), from 10 to 49.84 Hz (Follow IEC60068-2-6 standard)

### Installation site

The product shall be installed in the environment for easy operation, avoiding to be exposed to the following environments:

- Avoid direct sunlight
- Avoid rain drops or wet environment
- Avoid oil mist and salt erosion
- Avoid corrosive liquid and gas
- Avoid dust, lint fibers, and small metal filings.
- Avoid electromagnetic interference (soldering machine, power machine)
- Keep away from radioactive and flammable materials
- Avoid vibration (punch). Please add a vibration-proof pad to reduce vibration if it can not be avoided

## Screw Torques for terminals

To comply with UL standards, you shall use UL approved copper wires (rated 75 ° C) and round crimp terminals (UL Listed products) in the following table when connecting the main circuit terminal. TECO recommends using crimp terminals manufactured by NICHIFU Terminal Industry Co., Ltd and the terminal crimping tool recommended by the manufacturer for crimping terminals and the insulating sleeve.

Wire size mm <sup>2</sup> (AWG)	Terminal screw size	Model of the round crimp terminal	Fastening torque kgf.cm (in.lbs)	Model of insulating sleeve	Model of crimp tool
0.75 (18)	M3.5	R1.25-3.5	8.2 to 10 (7.1 to 8.7)	TIC 1.25	NH 1
	M4	R1.25-4	12.2 to 14 (10.4 to 12.1)	TIC 1.25	NH 1
1.25 (16)	M3.5	R1.25-3.5	8.2 to 10 (7.1 to 8.7)	TIC 1.25	NH 1
	M4	R1.25-4	12.2 to 14 (10.4 to 12.1)	TIC 1.25	NH 1
2 (14)	M3.5	R2-3.5	8.2 to 10 (7.1 to 8.7)	TIC 2	NH 1 / 9
	M4	R2-4	12.2 to 14 (10.4 to 12.1)	TIC 2	NH 1 / 9
	M5	R2-5	22.1 to 24 (17.7 to 20.8)	TIC 2	NH 1 / 9
	M6	R2-6	25.5 to 30.0 (22.1 to 26.0)	TIC 2	NH 1 / 9
3.5/5.5 (12/10)	M4	R5.5-4	12.2 to 14 (10.4 to 12.1)	TIC 5.5	NH 1 / 9
	M5	R5.5-5	20.4 to 24 (17.7 to 20.8)	TIC 5.5	NH 1 / 9
	M6	R5.5-6	25.5 to 30.0 (22.1 to 26.0)	TIC 5.5	NH 1 / 9
	M8	R5.5-8	61.2 to 66.0 (53.0 to 57.2)	TIC 5.5	NH 1 / 9
8 (8)	M4	R8-4	12.2 to 14 (10.4 to 12.1)	TIC 8	NOP 60
	M5	R8-5	20.4 to 24 (17.7 to 20.8)	TIC 8	NOP 60
	M6	R8-6	25.5 to 30.0 (22.1 to 26.0)	TIC 8	NOP 60
	M8	R8-8	61.2 to 66.0 (53.0 to 57.2)	TIC 8	NOP 60
14 (6)	M4	R14-4	12.2 to 14 (10.4 to 12.1)	TIC 14	NH 1 / 9
	M5	R14-5	20.4 to 24 (17.7 to 20.8)	TIC 14	NH 1 / 9
	M6	R14-6	25.5 to 30.0 (22.1 to 26.0)	TIC 14	NH 1 / 9
	M8	R14-8	61.2 to 66.0 (53.0 to 57.2)	TIC 14	NH 1 / 9
22 (4)	M6	R22-6	25.5 to 30.0 (22.1 to 26.0)	TIC 22	NOP 60/ 150H
	M8	R22-8	61.2 to 66.0 (53.0 to 57.2)	TIC 22	NOP 60/ 150H
30/38 (3 / 2)	M6	R38-6	25.5 to 30.0 (22.1 to 26.0)	TIC 38	NOP 60/ 150H
	M8	R38-8	61.2 to 66.0 (53.0 to 57.2)	TIC 38	NOP 60/ 150H
50 / 60 (1 / 1/ 0)	M8	R60-8	61.2 to 66.0 (53.0 to 57.2)	TIC 60	NOP 60/ 150H
	M10	R60-10	102 to 120 (88.5 to 104)	TIC 60	NOP 150H
70 (2/0)	M8	R70-8	61.2 to 66.0 (53.0 to 57.2)	TIC 60	NOP 150H
	M10	R70-10	102 to 120 (88.5 to 104)	TIC 60	NOP 150H
80 (3/0)	M10	R80-10	102 to 120 (88.5 to 104)	TIC 80	NOP 150H
	M16	R80-16	255 to 280 (221 to 243)	TIC 80	NOP 150H
100 (4/0)	M10	R100-10	102 to 120 (88.5 to 104)	TIC 100	NOP 150H
	M12	R100-12	143 to 157 (124 to 136)	TIC 100	NOP 150H
	M16	R80-16	255 to 280 (221 to 243)	TIC 80	NOP 150H

## 3.2 Installation

### 3.2.1 Installation space

- (1) Please install the A510 inverter in vertical direction, leaving enough space to ensure the cooling effect, shown in Figure 3.1.  
Avoid the upside-down or horizontal installation.

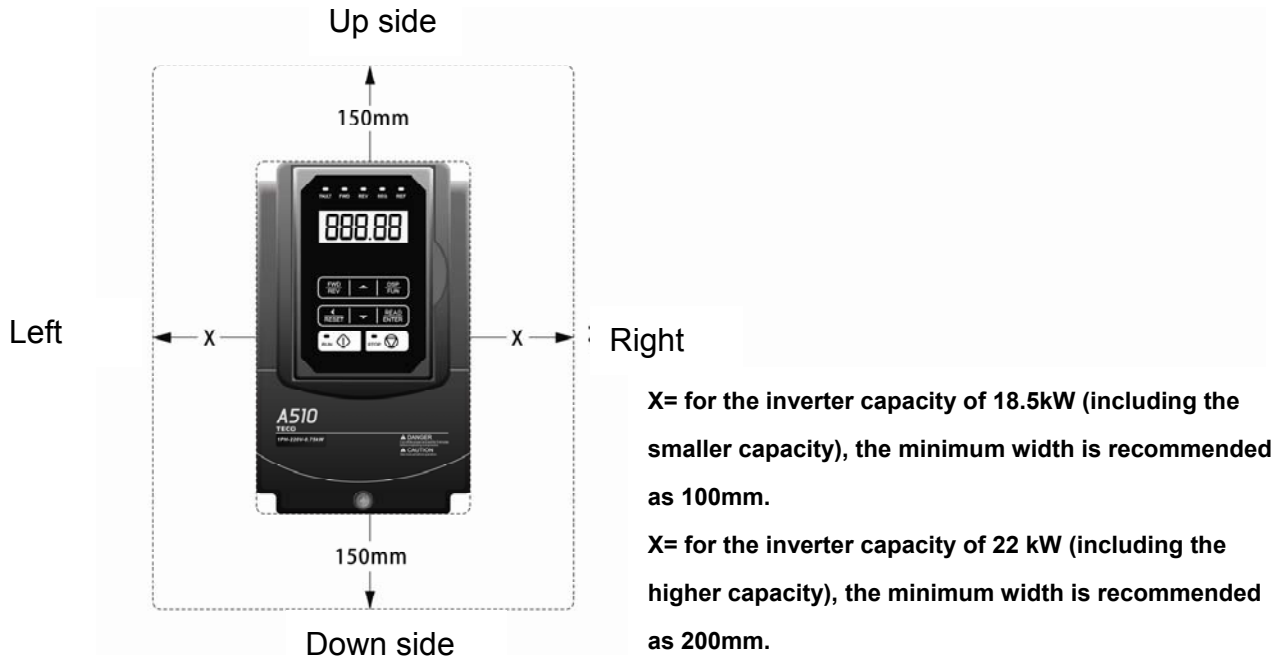

**Figure 3.1 A510 Installation Space**

- (2) The temperature of inverter's radiator cooling fins may reach 90 °C in operation.

Therefore, the contact surface for the inverter installation shall be made by the high-temperature-resistant material.

When the inverter is operating in the power distribution box, the environment must be ventilated and the environmental temperature must be less than +40 ° C.

### 3.2.2 External view of the product and warning label information

External view and part name of A510 inverter:

	<p>Caution</p>
<p>The installing environment of the inverter directly affects its functions and the service life. Therefore, the installation environment should be taken into account when installing A510 inverter:</p> <ul style="list-style-type: none"> <li>• Ambient temperature : <math>-10^{\circ}\text{C} \sim +40^{\circ}\text{C}</math> (NEMA 1 external installation type)</li> <li>• Avoid rain, humidity or direct sunlight.</li> <li>• Avoid corrosive liquid or gas, dust and metal filings</li> <li>• Avoid vibration; Keep away from electromagnetic interference</li> <li>• For multiple inverters installed in one plate, please equip with a fan for heat radiating in order to make the surrounding temperature of the inverter lower than <math>40^{\circ}\text{C}</math>.</li> </ul>	

(a) 220V 1-5HP/440V 1-7.5HP

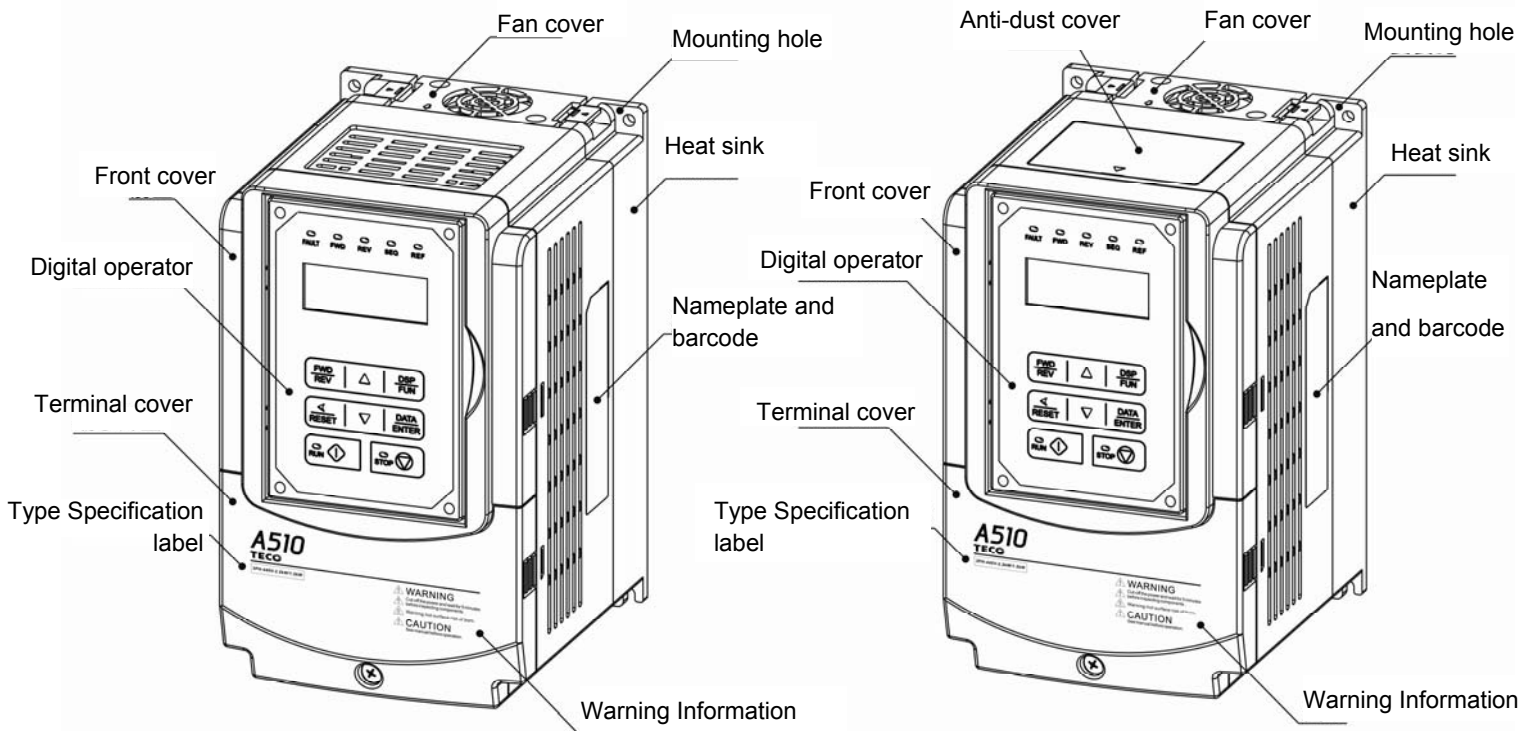

(Wall-mounted type, IEC IP 00)

(Wall-mounted type, IEC IP20, NEMA1)



(b) 220V 7.5-25HP/440V 10-30HP

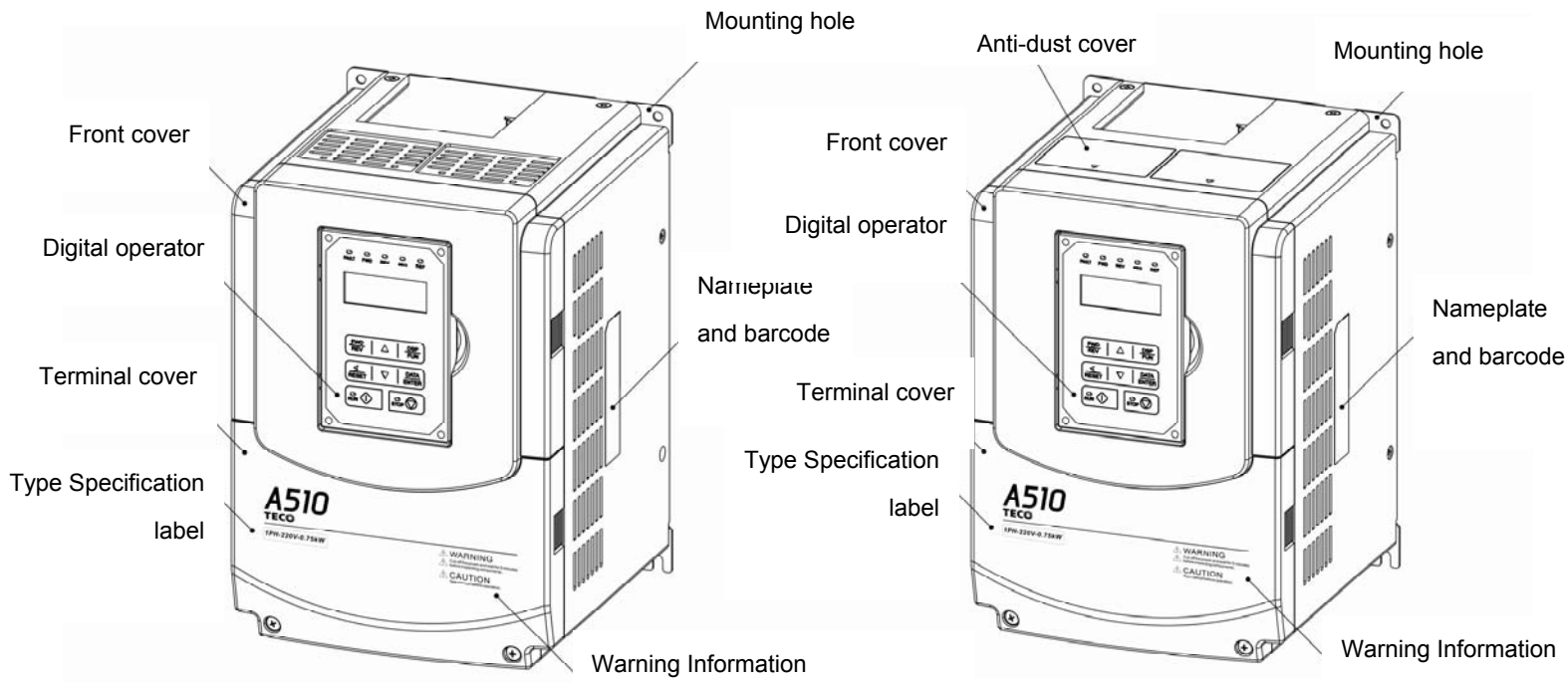

**(Wall-mounted type, IEC IP 00)**

**(Wall-mounted type, IEC IP20, NEMA1)**

(c) 220V 30-40HP/440V 40-60HP

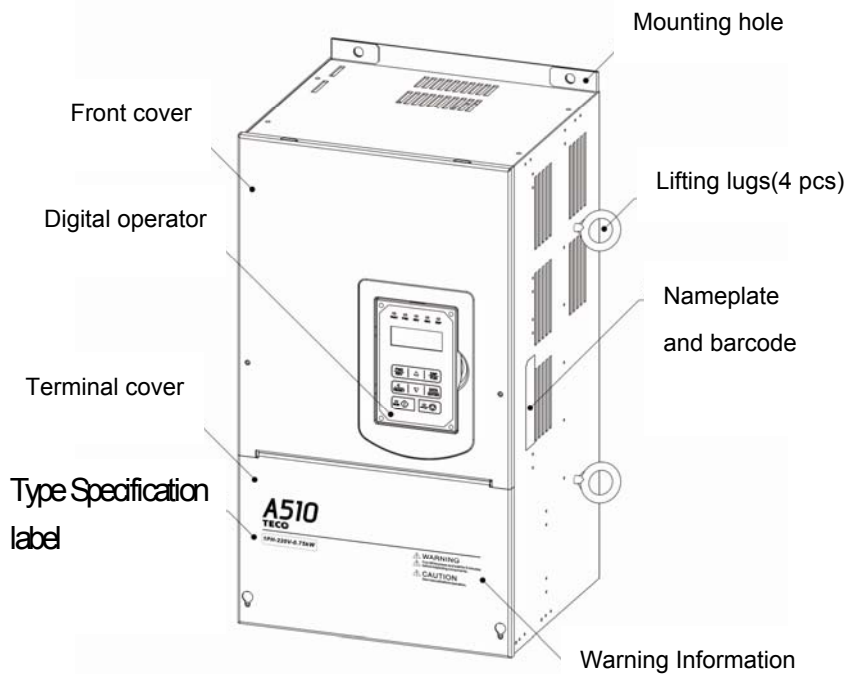

**(Wall-mounted type, IEC IP20, NEMA1)**

(d) 220V 50-100HP/440V 75-215HP

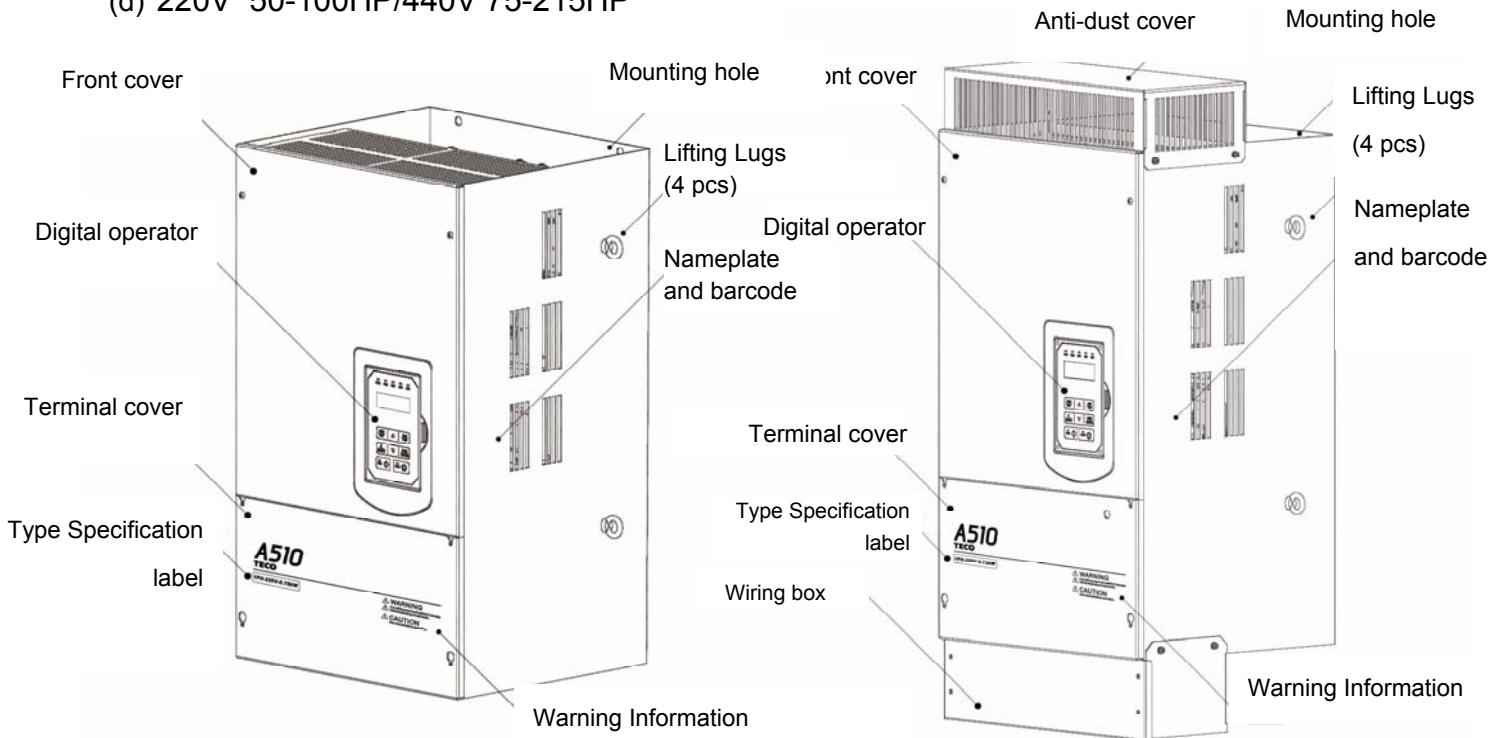

(wall-mounted type, IEC IP 00)

(wall-mounted type, IEC IP20, NEMA1)

**Figure 3.2 External view of A510**

Must be sure to read the warning information on the front cover, see Figure 3.3



(a) 220V: 7.5-10HP/440V: 10-15HP

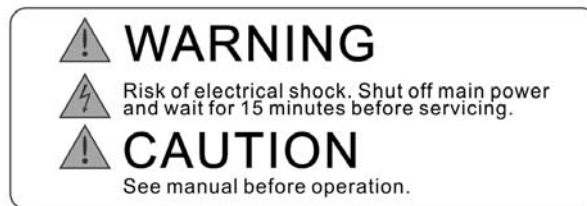

(b) 220V: 15-100HP/440V: 20-215HP

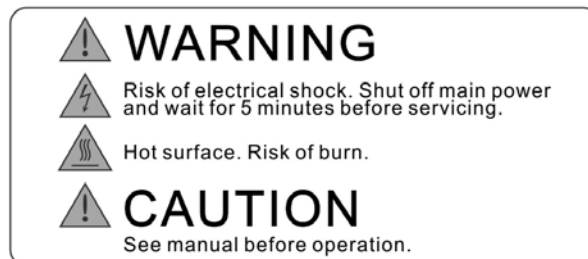

(c) 220V: 1-5HP/440V: 1-7.5HP

**Figure 3.3 Warning information label**

### 3.2.3 Product Dismounting



#### Caution

For A510 wiring, it is not necessary to disassemble the digital operator. First to loose screws of the external cover and take off the cover, then you can carry out the wiring work to the internal terminals of the inverter.

- Models of 220V 1-25HP and 440V 1-30HP are plastic shell. It is suggested to loose screws of the external cover and take off the cover. When wiring is completed, assemble the external cover of terminals and fasten screws.
- Models of 220V 30HP-100HP and 440V 40~215HP are metal shell. It is suggested to loose screws of the external cover and take off the cover. When wiring is completed, assemble the external cover of terminals and fasten screws.

Disassembly/assembly steps for various models of A510, as shown in following:

#### 3.2.3.1 Standard type

(a) 220V 1-5HP/440V 1-7.5HP

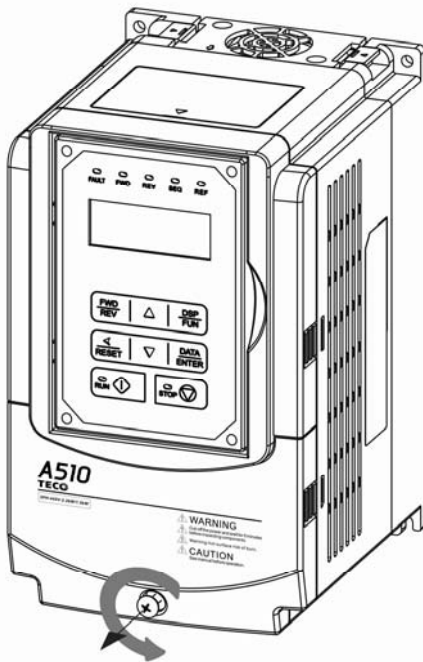

Step 1: Loose screws

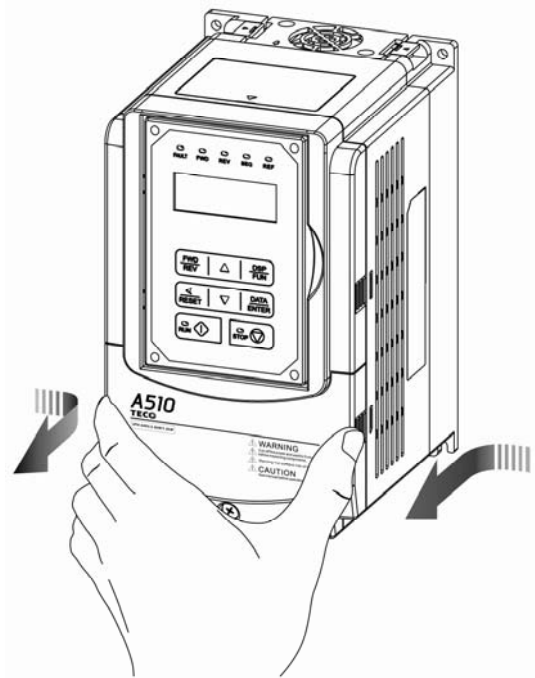

Step 2: Disassemble external cover

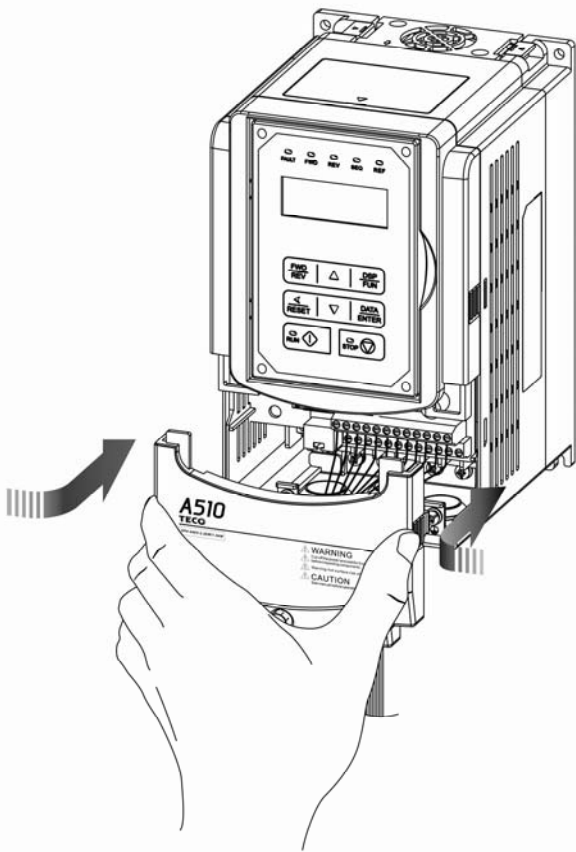

Step 3: Wiring and assemble the cover



Step 4: Fasten screws

(b) 220V 7.5-25HP/440V 10-30HP



Step 1: Loose screws

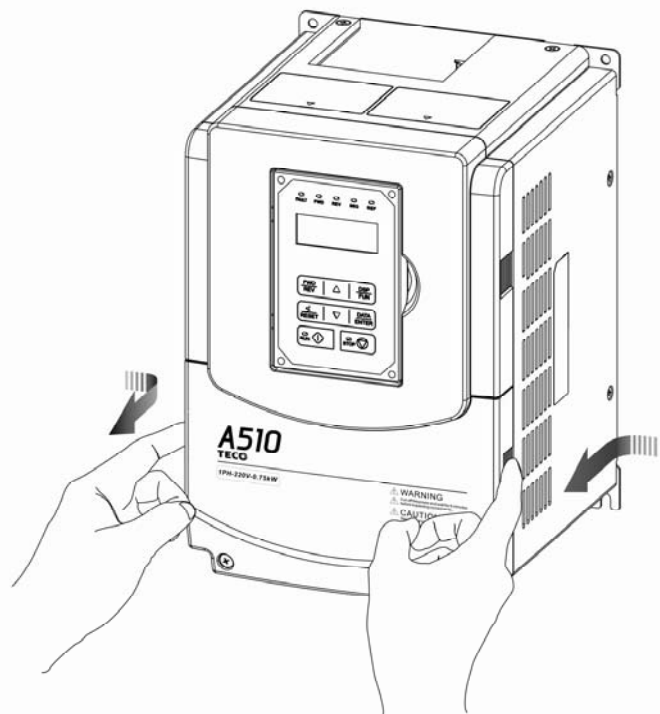

Step 2: Disassemble external cover

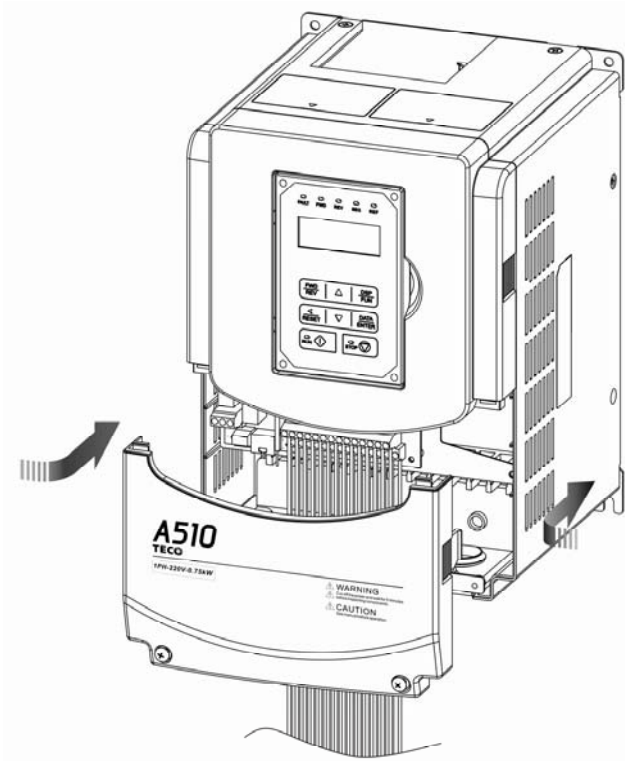

Step 3: Wiring and assemble the cover



Step 4: Fasten screws

(c) 220V 30-40HP/440V 40-60HP



Step 1: Loose screws

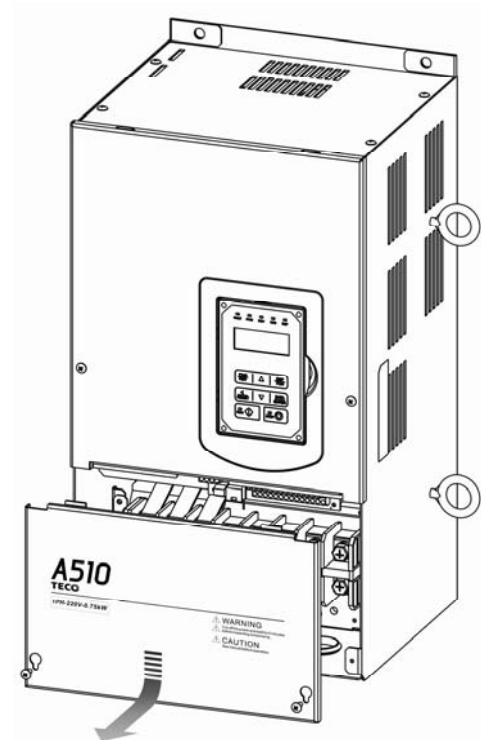

Step 2: Disassemble external cover

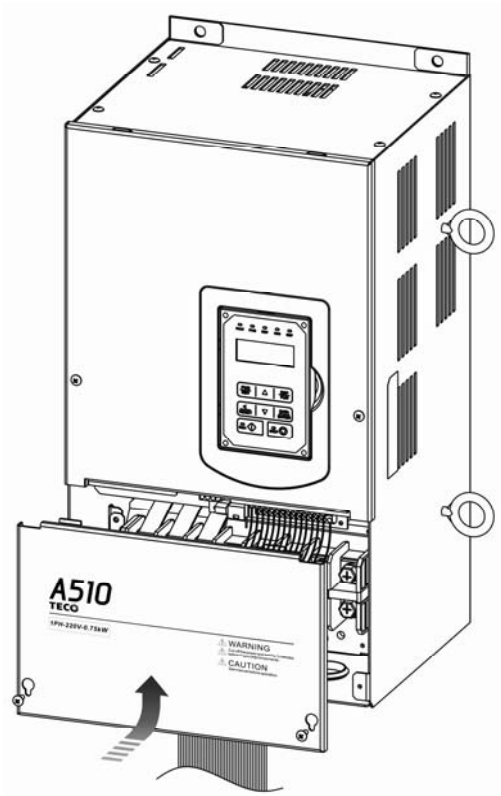

Step 3: Wiring and assemble the cover



Step 4: Fasten screws

(d) 220V 50-100HP/440V 75-215HP



Step 1: Loose screws

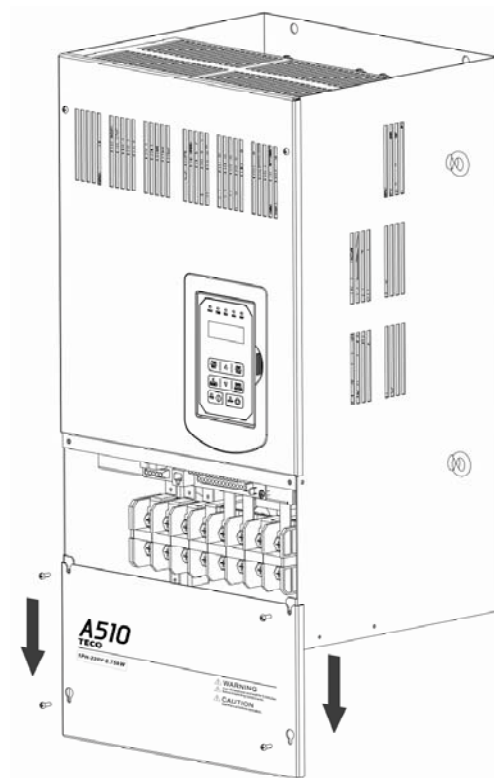

Step 2: Disassemble external cover

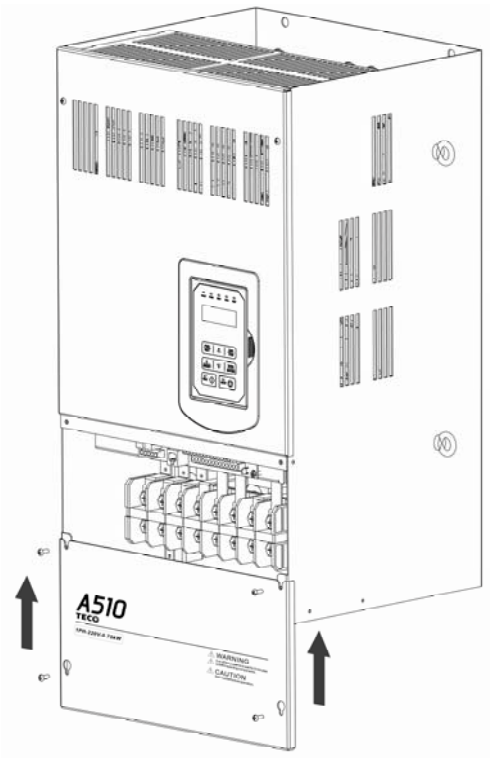

Step 3: Wiring and assemble the cover

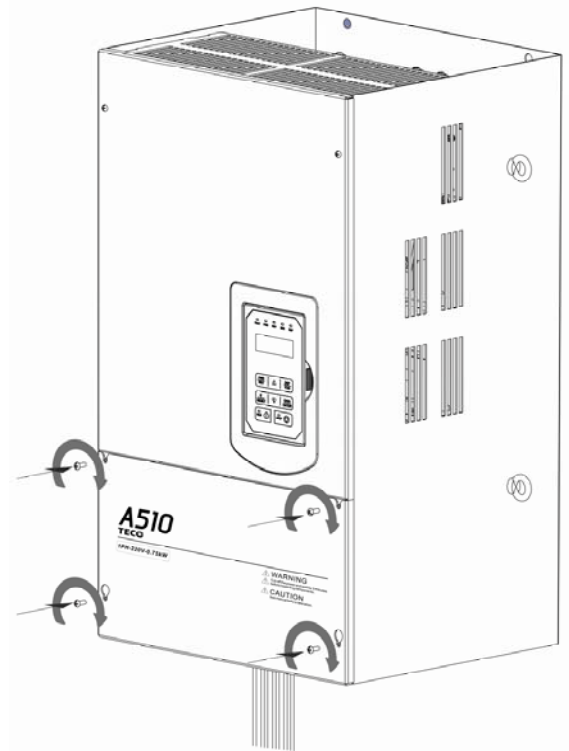

Step 4: Fasten screws

### 3.2.3.2 Built-in filter type (440V 1 ~60HP)



Step 1: Loose screws

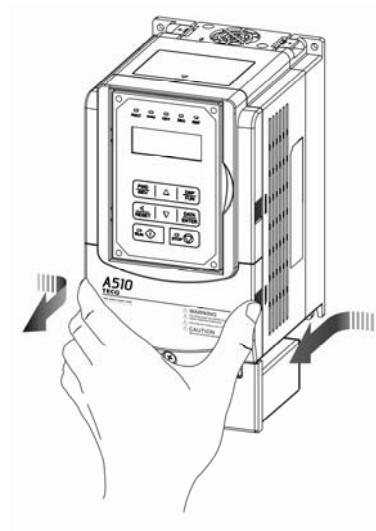

Step 2: Disassemble external cover

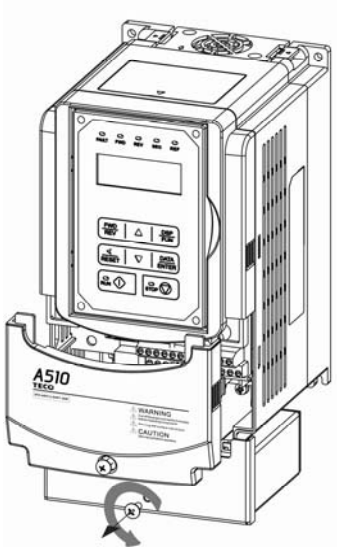

Step 3: Loose screws of filter

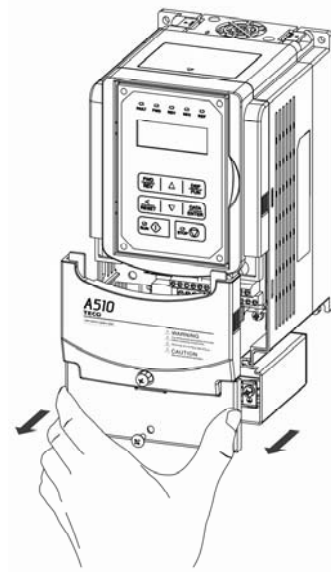

Step 4: Disassemble the external cover of the filter

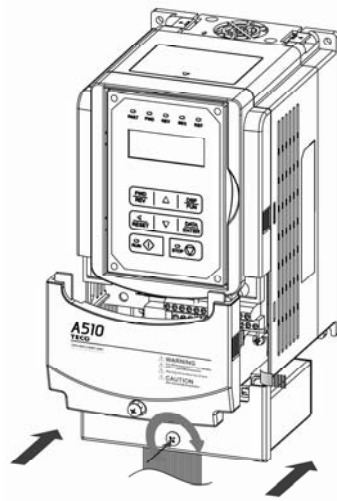

Step 5: Wiring and assemble the filter cover, then fasten screws

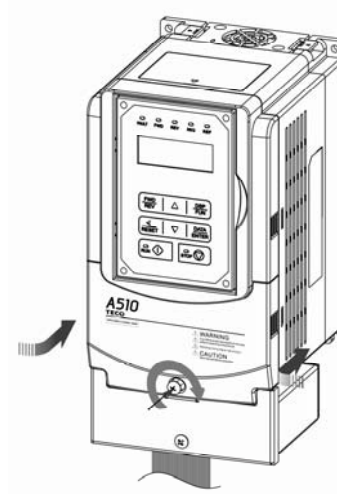

Step 6: Fasten screws



### 3.3 Wiring the peripheral devices of the inverter and related cautions



#### Cautions

1. After the power is cut off, while the “CHARGE” indicator of the inverter is still on, it means the discharge of the capacitor has not been completed. Don't touch the circuit or replace components at this time.
2. Never wire or disassemble/assemble internal connectors of inverter when the power is supplied.
3. Prohibit connecting U,V and W of inverter output terminals to AC power.
4. Terminal E of the inverter must be well grounded.
5. Since semiconductor components are easily damaged by high voltage, do not carry out the high voltage withstand test on internal components of A510 inverter.
6. CMOS IC of the inverter control board is easily affected and damaged by static electricity, thus, do not touch the control board.



#### Cautions

1. When wiring, please refer to the table for choosing appropriate wire diameter. If the main circuit line is too long, pay attention to the voltage drop which can not exceed 2% of the rated voltage.  
Phase voltage drop  $\Delta V = \sqrt{3} \times \text{wire resistance } (\Omega/\text{km}) \times \text{wiring distance (m)} \times \text{current (A)} \times 10^{-3}$
2. In case of a long wire between the inverter and the motor, please reduce the carrier frequency appropriately (parameters 11-01).



#### Cautions

To ensure the security of the interface device, it is recommended that a fast-acting fuse be added at the input side of the inverter, especially for high-power systems. The specification of applied fast-acting fuse can be referred to Section 6.6.

Examples for wiring the periphery devices of A510 are shown in the following:

Power supply



No Fuse Breaker (NFB) and Leakage Circuit Breaker

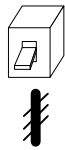

Electromagnetic contactor

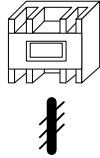

AC reactor

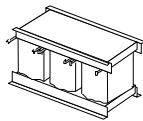

Fast acting fuse

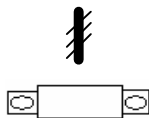

Input Noise filter

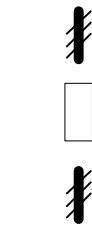

Inverter



Zero-phase noise filter



3-phase induction motor

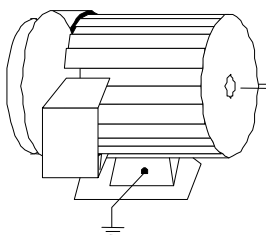

■ No fuse breaker (NFB) and Leakage Circuit Breaker

- Please refer to table 3 for choosing NFB of appropriate current.
- Do not use NFB to control the start/stop of the inverter.
- If a leakage circuit breaker is added for leakage protection, its current sensitivity shall be more than 200mA and action time more than 0.1 (V-TYPE), so as to avoid high-frequency malfunction.

■ Electromagnetic contactor

- It can not add the electromagnetic contactor for general use. However, for the application requiring external sequence control or automatic restart function after power cut, an electromagnetic contactor is required.
- Please avoid using electromagnetic contactor for the start/stop control of the inverter as possible.

■ AC reactor

- In case of further improving the power factor or suppress the external surge, an AC reactor can be additionally equipped.

■ Fast acting fuse

- To protect interface devices, it is necessary to add a fast acting fuse (fuse specification will be referred to Section 6.6)

■ Input Noise filter

- A510 is matched with TECO special filter, meeting the EN 55011 class A criterion.
- The selection of input noise filter can be referred to Section 6.4)

■ Inverter

- Terminal R,S,T at input side have no phase sequence requirement, thus they can be arbitrarily exchanged.
- Terminal E must be well grounded.

- Zero-phase noise filter
  - Adding a zero-phase noise filter at the output side of the inverter can decrease the radiated interference and induced noise.
  - Please refer to Section 6.5
  
- Motor
  - If an inverter drives multiple motors, the rated current of the inverter must be greater than the total current that all motors operate at the same time.
  - Motor and inverter must be grounded respectively.

## ■ Wiring

The following is the standard wiring diagram for the A510 inverter (© indicates main circuit terminal, ○ indicates control circuit terminal). Locations and symbols of the wiring terminal block might be different due to different models of A510. The description of main circuit terminal and control circuit terminal can be referred to table 1 and 2.

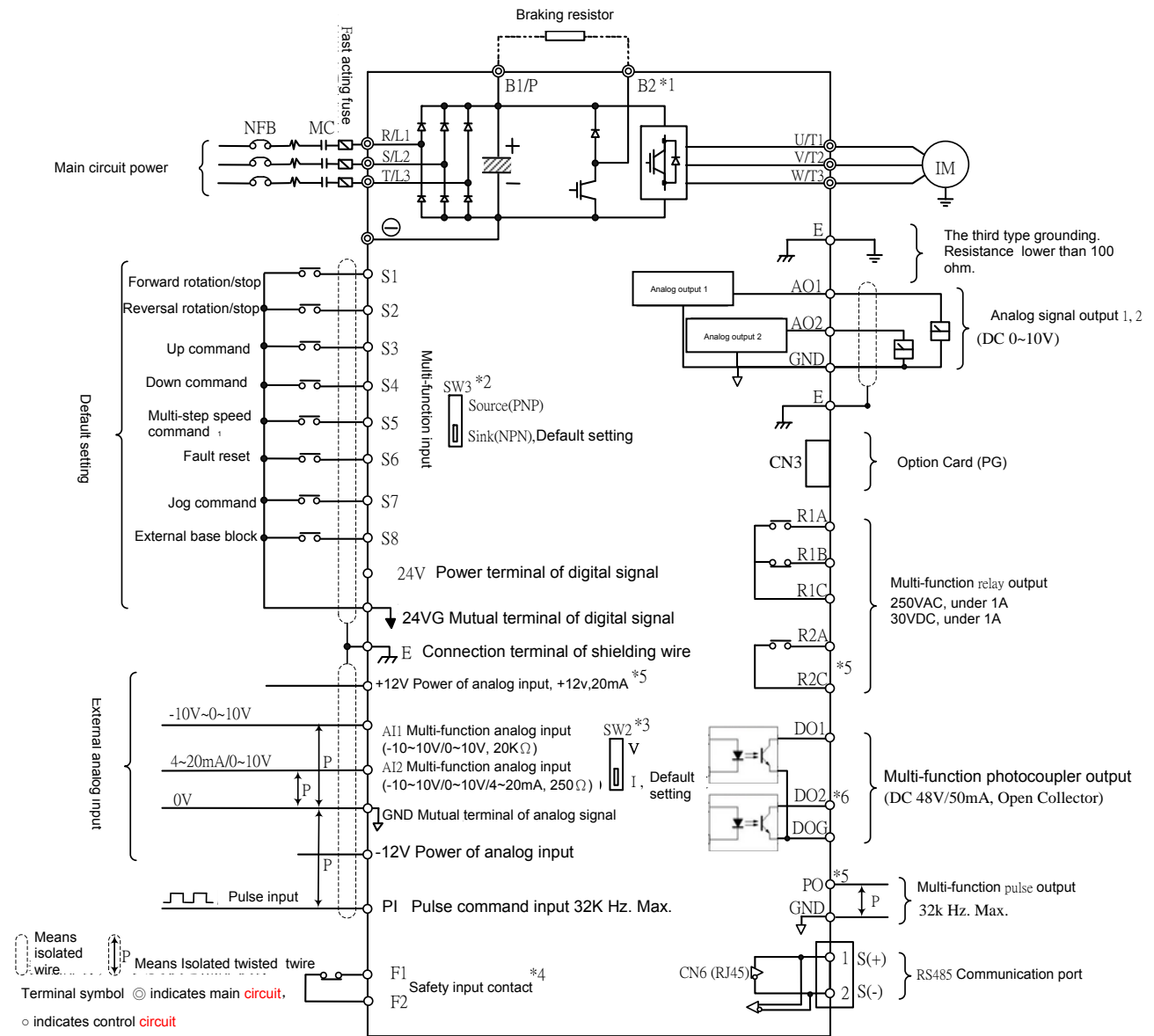

### Remark:

- \*1: Only the master circuit of 220V1~25HP and 440 V1~30HP (included) or models of lower capacity with built-in braking resistor provide terminal B2. The braking resistor can be connected directly between B1 and B2.
- \*2: The multi-function digital input terminals S1~S8 can be set to Source (PNP) or Sink (NPN) mode through the SW3.
- \*3: Multi-function analog input 2 (AI2) can be set to the voltage command input (0-10/-10-10v) or the current command input (4~20mA) through the SW3.
- \*4: Safety input connector F1 and F2 should be shorted so that the inverter outputs properly. When the safety input is used, please be sure to remove the short-pin between F1 and F2.
- \*5: Only 220 V 3HP and 440 v 5HP (included) or models above, provide terminals -12V, R2A-R2C and PO-GND.
- \*6: Only 220 V 2HP and 440 v 3HP (included) or models below, provide terminal DO2.

## 3.4 Functional description of terminals

### 3.4 Terminal Description

Table 1 Major Circuit Terminals

Terminal mark	220V: 1~25HP 440V: 1~30HP	220V: 30~100HP 440V: 40~215HP
R/L1	Power supply of the main terminal ( single phase, only connect R-S)	
S/L2		
T/L3		
B1 / P	<ul style="list-style-type: none"> <li>• B1 / P – ⊖: DC power supply</li> <li>• B1 / P – B2: externally connected braking resistor</li> </ul>	-
B2		
⊖		<ul style="list-style-type: none"> <li>• ⊕ - ⊖: DC power supply or connect braking detection module</li> </ul>
⊕	-	
U/T1	Inverter output	
V/T2		
W/T3		
E	Grounding terminal (the third type grounding)	

#### ■ Main Circuit Terminal Layouts

· 220V : 1 ~ 2HP , 440V : 1 ~ 3HP

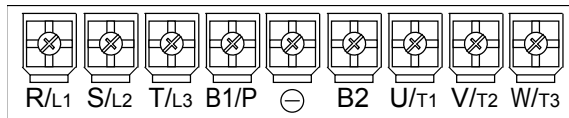

· 220V : 3 ~ 5HP , 440V : 5 ~ 7.5HP

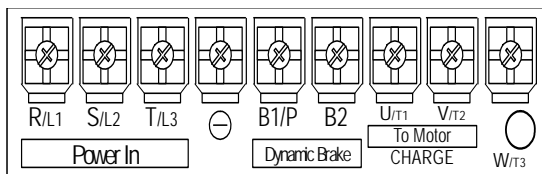

· 220V : 7.5~10HP , 440V : 10 ~ 15HP

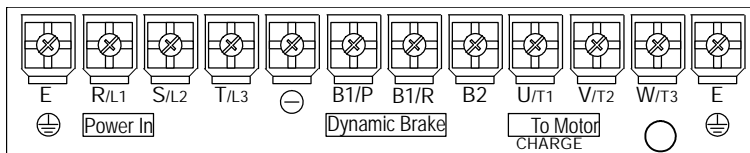

·220V : 15~25HP , 440V : 20 ~ 30HP

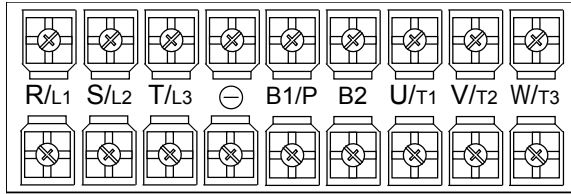

·220V : 30 ~40HP , 440V : 40 ~ 60HP

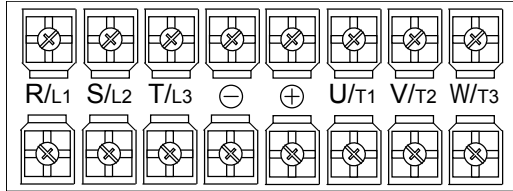

·220V : 50~60HP, 440V : 75~100HP

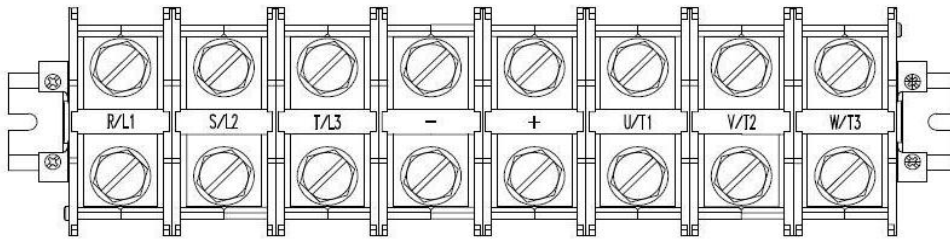

·220V : 75~100HP, 440V : 125~215HP

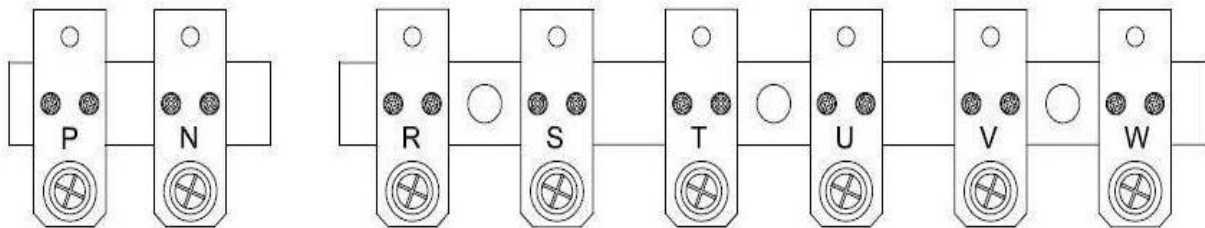

Table 2 Main circuit terminals

Type	Terminal	terminal function	Signal level
<b>Digital input signal</b>	S1	Forward rotation— stop command (default), multi-function input terminals * 1	24 VDC, 8 mA opto-coupler isolation (maximum voltage of 30 Vdc, input impedance of 9.03kΩ optocoupler)
	S2	Reversal rotation- stop command (default), multi-function input terminals * 1	
	S3	UP increases command(default), multi-function input terminals * 1	
	S4	DOWN reduces command(default), multi-function input terminals * 1	
	S5	Multi-step speed frequency command 1, multi-function input terminal* 1	
	S6	fault reset input, multi-function input terminal * 1	
	S7	JOG frequency command, multi-function input terminal * 1	
	S8	External B.B.(Base Block) input, multi-function input terminal * 1	
<b>24V Power supply</b>	24V	Digital signal SOURCE sharing point (SW3 switched to SOURCE )	±15%, Maximum output current: 250mA( the sum of all load )
	24VG	Common terminal of Digital signals Common point of digital signal SINK ( SW3 switched to SINK )	
<b>Analog input signal</b>	+12V	Power for speed setting	+12V ( Maximum current , 20mA)
	-12V	Only above 220V 3HP/ 440V 5HP (include) support this terminal function	-12V (Maximum current, 20mA)
	AI1	Voltage mastering speed command (0-10V input)/(-10V~10V input)	From 0 to +10V, From -10V to +10V (Input impedance : 20KΩ) (11bit + 1 symbol, resolution)
	AI2	Multi-function analog input terminals *2, can use SW2 to switch voltage or current input (0~10V)/(4-20mA)	From 0 to +10V, From -10V to +10V (Input impedance: 20KΩ) From 4 to 20 mA (Input impedance: 250KΩ) (11bit + 1 symbol, resolution)
	GND	Analog signals sharing terminal	----
	E	Shielding wire's connecting terminal (Ground)	----

Type	Terminal	terminal function	Signal level
Analog output signal	AO1	Multi-function analog output terminals *3 (0~10V output)	From 0 to 10V, ( Maximum current, 20mA ) (PWM 10KHz resolution )
	AO2	Multi-function analog output terminals *3 (0~10V output)	
	GND	Analog signals sharing terminal	
Pulse output signal	PO	Pulse output, BW 32KHz, only above 220V 3HP/ 440V 5HP (include) support this terminal function.	32KHz(max), +12V output (load: 2.2kΩ)
	GND	Analog signals sharing terminal	----
Pulse input signal	PI	Pulse command input, frequency width of 32KHz	L: from 0.0 to 0.5V H: from 4.0 to 13.2V 0 - 32 KHz(max)  (impedance:3.89 KΩ)
	GND	Analog signals sharing terminal	----
Digital output	DO1	Multi-function(open collector resistor) output: in operation, zero speed, frequency consistency, consistency at any frequency, output frequency , preparation completion, low-voltage detection, output breaker, rotation and frequency command, over-torque detection, abnormal, low-voltage, Overheat, motor overload, inverter overload, retrying, communication error, timing functional output device.....	48Vdc, 2~50mA Opto-coupling output
	DO2 (F1 only)		
	DOG	Sharing terminal of the open collector transistor	
Relay output	R1A	Relay A contact (multi-function output terminal)	Terminal capacity: at 250Vac, 10 mA~1A at 30Vdc, 10 mA~1A
	R1B		
	R1C	Relay B contact (multi-function output terminal) Relay common terminal, With the same function as DO1/DO2	
	R2A-R2C (above F2)	With the same function as DO1/DO2	
safety input	F1	on: free rotation with safe input off: general rotation (if use external safety switch to stop, you must remove the short circuit pin.)	24Vdc, 8mA, pull-high
	F2	Safety command common terminal	24V Ground
RS-485 port	S (+)	RS485/MODBUS	Opto-coupler isolation, differential input and output
	S (-)		
Grounding	E (G)	Grounding to earth Shield the connecting terminal	----



\*1:Multi-function digital input can be referred to the manual.

\*2:Multi-function analog input can be referred to the manual.

\*3:Multi-function analog output can be referred to the manual.



#### Caution

- Maximum output current capacity of the terminal 12V is 20mA.
- Multi-function analog output AO1 and AO2 are special for the analog output of meter. Please don't use them to the analog signal output of feedback control.
- Control board's 24V &  $\pm 12V$  just been used for internal control, please don't connect to external other devices to use.

### 3.5 Internal wiring diagram of main circuit

Various models of A510's internal wiring diagram of main circuit are shown as the following:

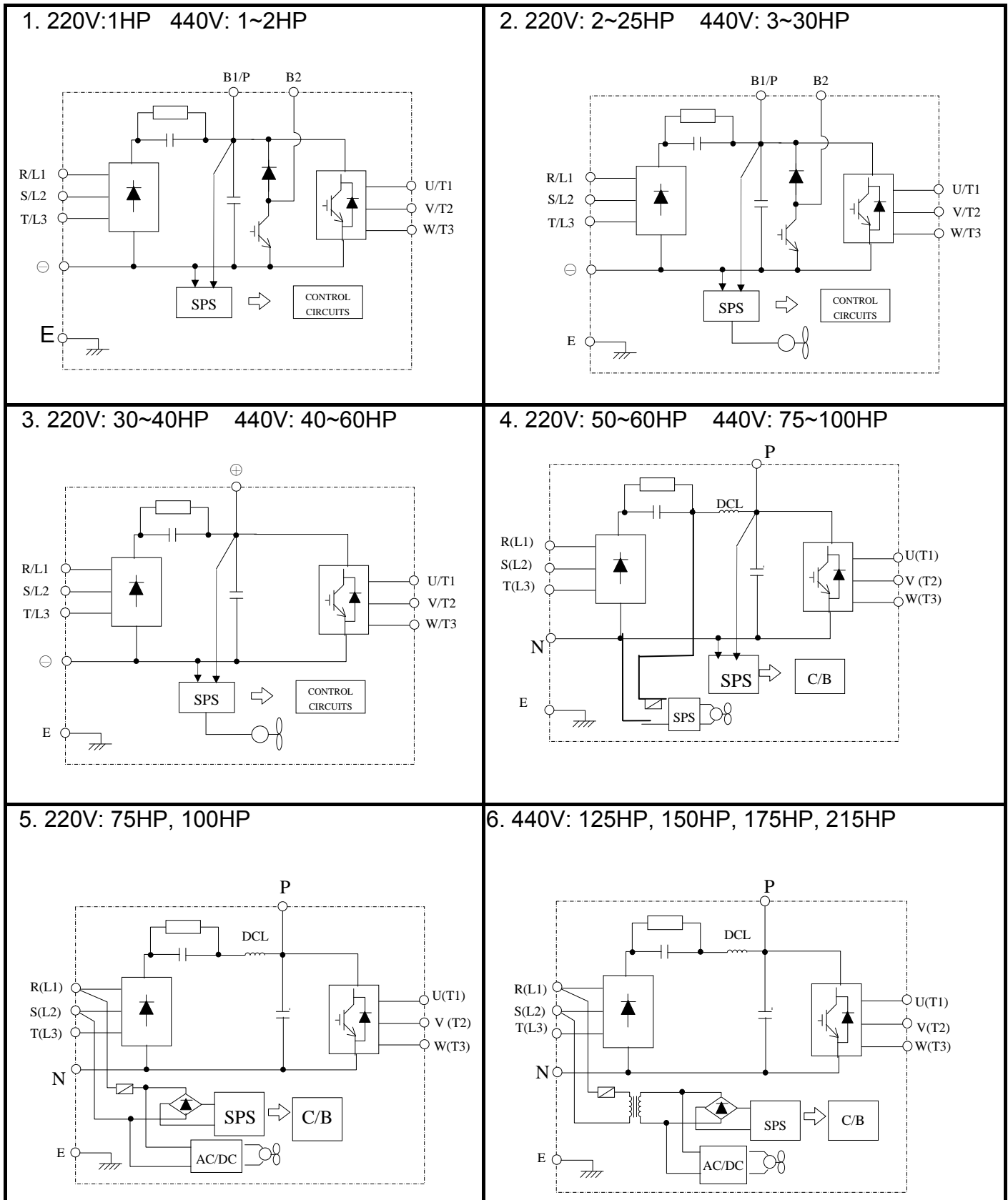

### 3.6 Instrument for main circuit wiring and caution

■ Instrument for main circuit wiring

Whether the MC should be installed or not is depended on the actual requirement, while the NFB must be installed between the AC supply and power input ports R, S, T of A510. If a leakage breaker is additionally added for protection to avoid the malfunction of leakage breaker, its current sensitivity shall be over 200mA, and acting time over 0.1 seconds.

Table 3 Wiring instrument for 220V / 440V class

Power	A510 Model			wire diameter (mm <sup>2</sup> )			NFB <sup>*4</sup>	MC <sup>*4</sup>
	horse power (HP) <sup>*1</sup>	Rated KVA	Rated current (A) HD/ND	Main circuit <sup>*2</sup>	Grounding line E(G)	Control line <sup>*3</sup>		
220V 1 ∅ / 3 ∅	1HP	1.9	5/6	2~5.5	2~5.5	0.5~2	TO-50EC(15A)	CU-11
	2HP	3	8/9.6	2~5.5	3.5~5.5	0.5~2	TO-50EC(20A)	CU-11
	3HP	4.2	11/12	3.5~5.5	3.5~5.5	0.5~2	TO-50EC(30A)	CU-11
220V 3 ∅	5.4HP	6.7	17.5/21	5.5	5.5	0.5~2	TO-50EC(30A)	CU-16
	7.5HP	9.5	25/30	8	5.5~8	0.5~2	TO-100S(50A)	CU-18
	10HP	12.6	33/40	8	5.5~8	0.5~2	TO-100S(50A)	CU-25
	15HP	17.9	47/56	14	8	0.5~2	TO-100S(100A)	CU-50
	20HP	22.9	60/69	22	8	0.5~2	TO-100S(100A)	CU-65
	25HP	28.6	73/79	22	14	0.5~2	TO-225S(100A)	CU-80
	30HP	32.4	85/110	38	14	0.5~2	TO-225S(150A)	CN-100
	40HP	43.8	115/138	60	22	0.5~2	TO-225S(175A)	CN-125
	50HP	55.3	145/169	80	22	0.5~2	TO-225S(200A)	CN-150
	60HP	68.6	180/200	100	22	0.5~2	TO-225S(225A)	CN-180
	75HP	81.9	215/250	150	22	0.5~2	TO-400S(300A)	CN-300
	100HP	108	283/312	200	38	0.5~2	TO-400S(400A)	CN-300
	125HP	132	346/360					
150HP	158	415/450						
440V 3 ∅	1HP	2.6	3.4/4.1	2~5.5	2~5.5	0.5~2	TO-50EC(15A)	CU-11
	2HP	3.2	4.2/5.4	2~5.5	3.5~5.5	0.5~2	TO-50EC(15A)	CU-11
	3HP	4.2	5.5/6.9	2~5.5	3.5~5.5	0.5~2	TO-50EC(15A)	CU-11
	5.4HP	7	9.2/11.1	2~5.5	3.5~5.5	0.5~2	TO-50EC(15A)	CU-18
	7.5HP	11.3	14.8/17.5	3~5.5	3.5~5.5	0.5~2	TO-50EC(20A)	CU-18
	10HP	13.7	18/23	5.5	5.5	0.5~2	TO-50EC(30A)	CU-25
	15HP	18.3	24/31	8	8	0.5~2	TO-100S(50A)	CU-25
	20HP	23.6	31/38	8	8	0.5~2	TO-100S(50A)	CU-35
	25HP	29.7	39/44	8	8	0.5~2	TO-100S(50A)	CU-50
	30HP	34.3	45/58	14	8	0.5~2	TO-100S(75A)	CU-50
	40HP	45.7	60/72	22	8	0.5~2	TO-100S(100A)	CU-65
	50HP	57.2	75/88	22	14	0.5~2	TO-100S(100A)	CU-80
	60HP	69.3	91/103	38	14	0.5~2	TO-225S(150A)	CN-100
	75HP	85.4	118/145	60	22	0.5~2	TO-225S(175A)	CN-125
	100HP	114	150/165	80	22	0.5~2	TO-225S(225A)	CN-150
	125HP	137	180/208	150	22	0.5~2	TO-400S(300A)	CN-300
	150HP	165	216/250	150	22	0.5~2	TO-400S(300A)	CN-300
175HP	198	260/296	200	30	0.5~2	TO-400S(400A)	CN-300	

Power	A510 Model			wire diameter (mm <sup>2</sup> )			NFB <sup>*4</sup>	MC <sup>*4</sup>
	horse power (HP) <sup>*1</sup>	Rated KVA	Rated current (A) HD/ND	Main circuit <sup>*2</sup>	Grounding line E(G)	Control line <sup>*3</sup>		
	215HP	225	295/328	250	30	0.5~2	TO-400S(400A)	CN-300
	250HP	270	352/380					
	300HP	317	415/470					
	375HP	400	523/585					

\*1: Fixed torque load shall prevail.

\*2: The main circuit contains R/L1, S/L2, T/L3, U/T1, V/T2, W/T3, B1 / P, B2, ⊖, ⊕.

\*3: Control line is the terminal wire on the control board.

\*4: The NFB and MCB listed in the table are of TECO product numbers, products with same rated specification of other brands are available. To reduce electrical noise interference, please ensure that R-C surge absorber (R: 10Ω/5W, C: 0.1μf/1000VDC) are added at both sides of MCB coil.

\*5: 220V 125HP/ 440V 250HP or above is being developed.

For the external wiring, please attention to the followings:

(A) Control Circuit wiring:

- (1) Control circuit wiring (control terminal) must be isolated from main circuit wiring (R, S, T, U, V, W) and other power lines, so as to avoid electrical noise interference.
- (2) Contact output terminal R1A, R1B, R1C (or R2A, R2C) must be isolated from terminal ①~⑧, A01, A02, GND, DO1, DO2, DOG, +12V-, -12V, AI1, AI2, GND when wiring.
- (3) In order to avoid the electrical noise interference, the control circuit wiring must adopt shielding isolation twisted wire, please refer to the following diagram; the wiring distance should not exceed 50m.

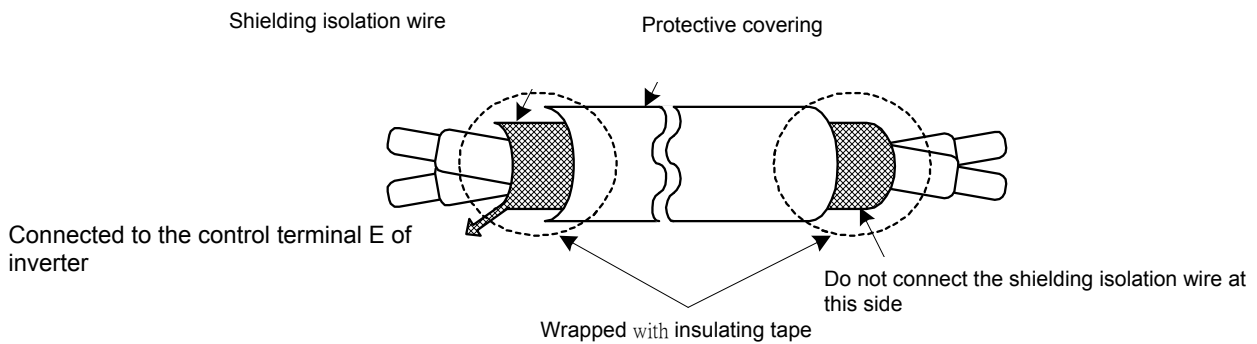

Figure 3 Isolation twisted wire treatment

When connecting the output contact of the multi-function optocoupler to the relay, it is necessary to add flywheel diode in parallel to both sides of the relay coil, as shown in the following diagram.

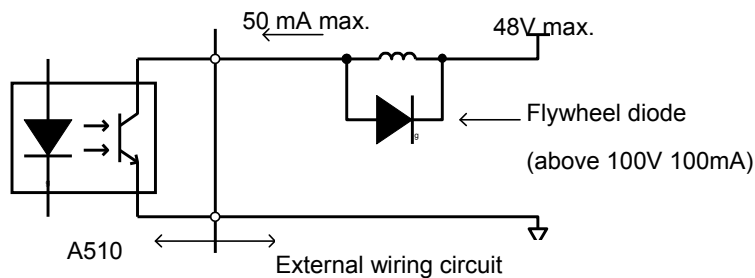

Figure 4 Optical coupler output contacts connected inductive load

(B) Main Circuit wiring :

- (1) It doesn't need to consider the phase sequence for input power R, S, T.
- (2) Prohibit connecting U,V and W of inverter output terminals to AC power.
- (3) Inverter output terminal U, V and W are connected to the motor terminal U, V, W. If the inverter executes forward rotation instruction while the motor rotates in reversal direction, simply exchange any two wires of U, V, W is enough.
- (4) Never connect the inverter output terminal to the capacitor or LC,RC noise filter of improving the power factor.

(C) Grounding wire :

- (1) Grounding terminal (E) is grounded to the earth by the third type grounding way. (grounding resistance of 100Ω or less)
- (2) Inverter grounding wire can not be grounded together with high-current loads such as welding machines and high-powered motors and so on. They must be grounded respectively.
- (3) Grounding wire size follows the specification of electrical equipment technical basis. The shorter grounding wire is, the better it is.
- (4) If several inverters are grounded jointly, please refer to the following diagrams for grounding. Do not form a circuit in grounding.

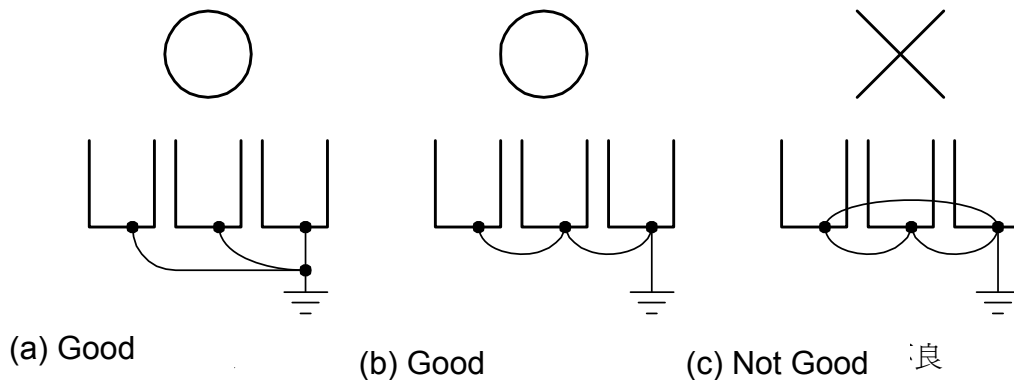

Figure 5 Grounding ways of several A150 jointly

◎ Determine wire size

When choosing wire, a consideration of the voltage drop caused by the wire is a must.

Voltage drop is calculated as shown below. In general, the voltage drop shall be controlled below 2% of the rated voltage. Voltage drop between wires (V) = × wire resistance (Ω / km) × wiring length (m) × current (A) × 10<sup>-3</sup>

◎ AC reactor for parallel power coordination

If the capacity exceeds 600kVA, please add AC reactor to the input side of the inverter in series. AC power can be used for power coordination and power factor improvement.

◎ Wiring length between the inverter and the motor

If the total length between the inverter and the motor, the inverter itself and other peripheral devices will be affected because the high-frequency carrier frequency (ie, the IGBT ON / OFF switching frequency) of the inverter will increase the leakage current between wiring and the ground. As a result, if the wiring length between the inverter and the motor is very long, please modestly reduce the carrier frequency, as shown below.

Wiring distance between the inverter and the motor	<30m	30m ~ 50m	50m ~100m	≥ 100m
Allowable carrier frequency (set values of 11-01 )	16kHz(max)	10kHz(max)	5kHz(max)	2kHz(max)

## 3.7 Inverter Specifications

- Basic Specifications

(a) 220V class

Inverter capacity (HP)		1	2	3	5	7.5	10	15	20	25	30	40	50	60	75	100	125	150		
Output rated	Rated output Capacity (KVA)	1.9	3	4.2	6.7	9.5	12.6	17.9	22.9	28.6	32.4	43.8	55.3	68.6	81.9	108	132	158		
	Heavy-load type H.D.(150%/1 min)	Rated output current (A)	5	8	11	17.5	25	33	47	60	73	85	115	145	180	215	283	346	415	
		Maximum applicable motor <sup>*1</sup> HP (KW)	1 (0.75)	2 (1.5)	3 (2.2)	5 (3.7)	7.5 (5.5)	10 (7.5)	15 (11)	20 (15)	25 (18.5)	30 (22)	40 (30)	50 (37)	60 (45)	75 (55)	100 (75)	125 (90)	150 (110)	
	Standard-load type N.D.(120%/1 min)	Rated output current (A)	6	9.6	12	21	30	40	56	69	79	110	138	169	200	250	312	360	450	
		Maximum applicable motor <sup>*1</sup> HP (KW)	1.5 (1.1)	3 (2.2)	4 (3)	7.5 (5.5)	10 (7.5)	15 (11)	20 (15)	25 (18.5)	30 (22)	40 (30)	50 (37)	60 (45)	75 (55)	100 (75)	125 (90)	150 (110)	175 (130)	
	The maximum output voltage (V)		3-phase, 200V~240V																	
The maximum output frequency (Hz)		Based on parameter setting 0.1~400.0(1200.0) Hz																		
Power	Rated voltage, frequency	Single/3-phase 200V~240V, 50/60Hz			3-phase 200V~240V, 50/60Hz															
	Allowable voltage fluctuation	-15% ~ +10%																		
	Allowable frequency fluctuation	±5%																		

(b) 440V class

Inverter capacity (HP)		1	2	3	5	7.5	10	15	20	25	30	40	50	60	75	100	125	150	175	215	
Output rated	Rated output Capacity (KVA)	2.6	3.2	4.2	7	11.3	13.7	18.3	23.6	29.7	34.3	45.7	57.2	69.3	85.4	114	137	165	198	225	
	Heavy-load type H.D.(150%/1 min)	Rated output current (A)	3.4	4.2	5.5	9.2	14.8	18	24	31	39	45	60	75	91	118	150	180	216	260	295
		Maximum applicable motor <sup>*1</sup> HP (KW)	1 (0.75)	2 (1.5)	3 (2.2)	5 (4)	7.5 (5.5)	10 (7.5)	15 (11)	20 (15)	25 (18.5)	30 (22)	40 (30)	50 (37)	60 (45)	75 (55)	100 (75)	125 (90)	150 (110)	175 (132)	215 (160)
	Standard-load type N.D.(120%/1 min)	Rated output current (A)	4.1	5.4	6.9	11.1	17.5	23	31	38	44	58	72	88	103	145	165	208	250	296	328
		Maximum applicable motor <sup>*1</sup> HP (KW)	2 (1.5)	3 (2.2)	4 (3)	7.5 (5.5)	10 (7.5)	15 (11)	20 (15)	25 (18.5)	30 (22)	40 (30)	50 (37)	60 (45)	75 (55)	100 (75)	125 (90)	150 (110)	175 (132)	215 (160)	250 (185)
	The maximum output voltage (V)		3-phase 380V~480V																		
The maximum output frequency (Hz)		Based on parameter setting 0.1~400.0(1200.0) Hz																			
Power	Rated voltage, frequency	3-phase 380V ~ 480V, 50/60Hz																			
	Allowable voltage fluctuation	-15% ~ +10%																			
	Allowable frequency fluctuation	±5%																			



Inverter capacity (HP)		250	300	375	
rated Output	Rated Output capacity (KVA)	270	317	400	
	Heavy-load type H.D.(150%/1min)	Rated output current (A)	370	450	523
		Maximum applicable motor <sup>*1</sup> HP (KW)	250 (185)	300 (220)	375 (280)
	Standard-load type N.D.(120%/1min)	Rated output current (A)	435	515	600
		Maximum applicable motor <sup>*1</sup> HP (KW)	270 (200)	335 (250)	425 (315)
	The maximum output voltage (V)	3-phase 380V~480V			
The maximum output frequency (Hz)	Based on parameter setting 0.1~400.0 Hz				
Power	Rated voltage, frequency	3-phase 380V ~ 480V, 50/60Hz			
	Allowable voltage fluctuation	-15% ~ +10%			
	Allowable frequency fluctuation	±5%			

- \* 1 Take standard 4-pole induction motor as the base.
- \* 2 HD (heavy load type): 150% / 1 min, 200% / 2sec, carrier range: 2KHZ ~ 16KHZ , the factory setting is 8KHZ (220V ~ 20HP / 440V ~ 30HP).
- \* 3 HD (heavy load type): 150% / 1 min, 200% / 2sec, carrier range: 2KHZ ~ 12KHZ, the factory setting is 5KHZ (440V 40 ~ 50HP).
- \* 4 HD (heavy load type): 150% / 1 min, 200% / 2sec, carrier range: 2KHZ ~ 12KHZ, the factory setting is 6KHZ (220V 25HP).
- \* 5 HD (heavy load type): 150% / 1 min, 200% / 2sec, carrier range: 2KHZ ~ 12KHZ, the factory setting is 5KHZ (220V 30 ~ 40HP).
- \* 6 HD (heavy load type): 150% / 1 min, 200% / 2sec, carrier range: 2KHZ ~ 10KHZ , the factory setting is 5KHZ (220V 50 ~ 100HP/440V 60 ~ 175HP).
- \* 7 HD (heavy load type): 150% / 1 min, 200% / 2sec carrier range: 2KHZ ~ 8KHZ, the factory setting is 3KHZ (440V 215HP).
- \* 8 ND (standard load type): 120% / 1 min, carrier range: 2KHZ ~ 16KHZ, the factory setting is 2KHZ.
- \* 9 A510 model is designed to use in heavy load conditions, the factory setting takes HD (heavy load type) as the base.
- \* 10 if it is greater than factory carrier frequency, you need to adjust the load current based on the de-rating curve.
- \* 11. 220V 125HP / 440V 250HP models or above are being developed.

The following shows maximum frequencies under different control modes.

Load mode	Control mode	Other settings	Maximum frequency
Heavy load (00-27=0)	V/F V/F + PG	maximum frequency set to 400Hz (00-31 = 0)	400Hz
		maximum frequency set to 1200Hz (00-31 = 1)	1200Hz
	SLV	220V 1~10HP, 440V 1~15HP	150Hz
		220V 15~25HP, 440V 20~30HP	110Hz
		220V 30~100HP, 440V 40~375HP	100Hz
	SV	unlimited	400Hz
	PMSV	unlimited	400Hz
Slight load (00-27=1)	V/F V/F + PG	maximum frequency set to 400Hz (00-31 = 0)	120Hz
		maximum frequency set to 1200Hz (00-31 = 1)	1200Hz

▪ General Specifications

Control characteristics	Operation mode	Seven-segment display * 5 + LED keypad (it is allowable to buy LCD keypad with parameter copy function)
	Control mode	V/F, V/F+PG, SLV, SV, PMSV, PMSLV with space vector PWM mode
	Frequency control range	0.1Hz~400.0Hz(1200.0Hz)
	Frequency accuracy (Temperature change)	Digital references: $\pm 0.01\%$ (-10 ~ +40°C), Analog references: $\pm 0.1\%$ (25°C $\pm 10^\circ\text{C}$ )
	Speed control accuracy	$\pm 0.1\%$ ( vector control(SV)), $\pm 0.5\%$ ( vector control without sensor)
	Frequency setting resolution	Digital references:0.01Hz , Analog references: 0.06Hz/60Hz
	Output frequency resolution	0.01Hz
	Overload Tolerance	rated output current 150%/1 min, 200%/2sec(H.D mode),120%/1 min (N.D mode), factory setting of 150%/1 min, 200%/2sec
	frequency setting signal	DC 0 ~ +10V / 4 ~ 20mA or DC-10V~-+10V and pulse -type command frequency
	Acceleration / deceleration time	0.0~6000.0 second (separately set acceleration and deceleration time )
	Voltage, frequency characteristics	Can arbitrarily set V / f curve based on parameters
	Braking torque	About 20%
	Protection functions	Main control functions
Other functions		Accumulated record of power supply time and operation time, 4 sets of fault history record and the latest fault record state, energy-saving function setting, single phasing protection, smart braking,DC braking, Dwell, S curve acceleration and deceleration, Up / Down operation, MODBUS communication type, output of pulse multiple, display of any engineering unit, Local / Remote switching keys, SINK / SOURCE input interface option
Stall protection		Action current can be set (in acceleration or constant speed, it can be set separately. In deceleration, it can be set with / without)
Instantaneous over current (OC) and output short-circuit (SC) protection		It stops when the current exceeds 200% of the inverter rated current.
Inverter overload Protection (OL2)		inverter rated current is 150%/1 min., in case of 200%/2sec, it stops (H.D type),carrier of the factory setting is 8~2KHZ. In case of 120%/1 min, it stops(N.D. type), carrier of the factory setting is 2KHZ.
Motor overload (OL1) protection		Electrical overload protection curve
Over voltage(OV) protection		If the main circuit DC voltage is over 410V (220V class) / 820V (440V class), the motor stops running.
Under voltage (UV)		If the main circuit DC voltage is under 190V (220V class) / 380V (440V class), the motor stops running.
Automatic restart after instantaneous power fault		Power fault exceeds 15ms You can set the function of automatic restart after instantaneous power fault in 2sec
Overheat protection(OH)		Use temperature detector for protection
Environment Specification	Ground Fault protection(GF)	Use current detector for protection
	Protection in charge state	When main circuit DC voltage $\geq 50\text{V}$ , the CHARGE LED is on.
	Output Phase Loss Protection (OPL)	If the OPL function acts, the motor stops rotation automatically.
	Location	Indoor (protected from corrosive gases and dust)
	Ambient temperature	-10~+40°C without de-rating (IP20/NEMA1), -10~+50°C (IP00), with de-rating, its maximum operation temperature is 60°C
Option	Storage temperature	-20~+70°C
	Humidity	95%RH or less ( no condensation )
	Altitude and vibration	altitude of 1000 meters or lower, below.5.9m/s2(0.6G)
	Communication function	RS-485 standard with built-in (MODBUS) (RJ45)
	PLC function	Built-in
EMI protection	The added noise filter is in line with EN61800-3 , 400V 215HP or below can be built in.	
EMS protection	Follows EN61800-3	
Option	open pole/wire drive/PM encoder feedback card	

■ Derating curve based on the carrier

(a) 220Vmodel

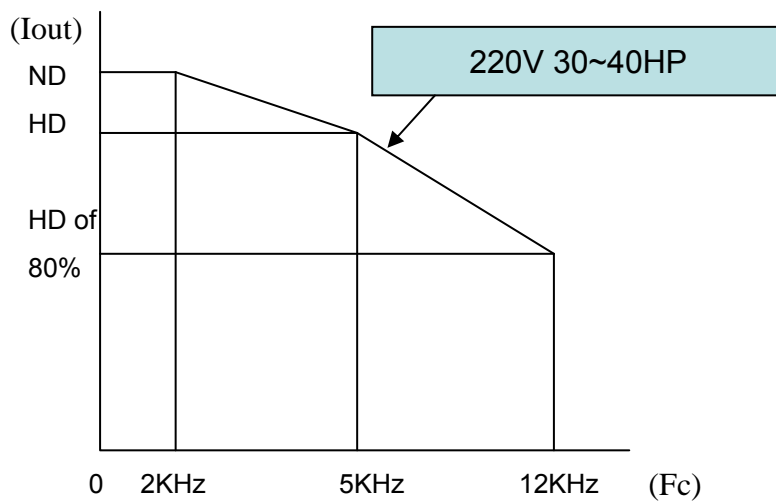
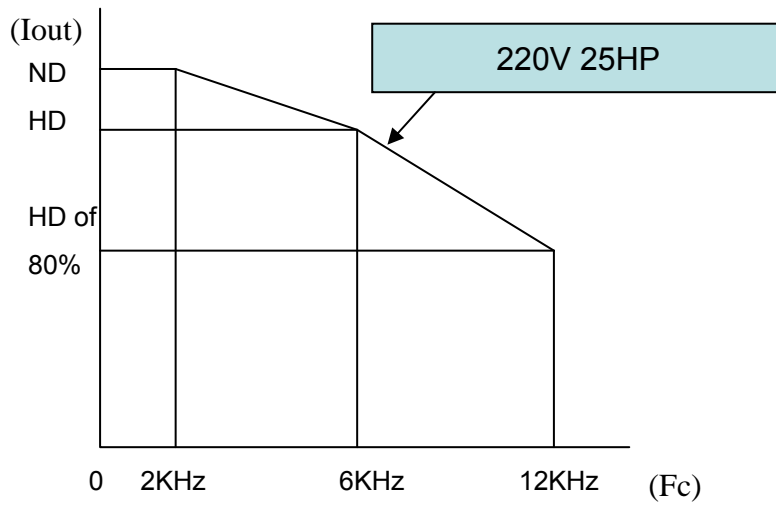
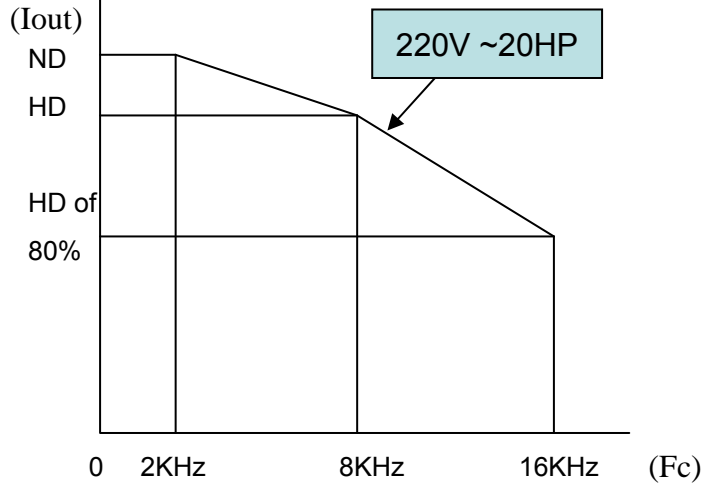

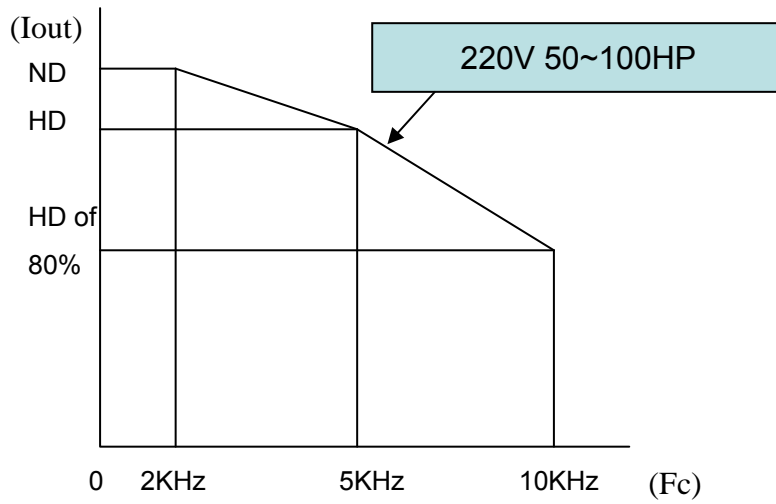

(b) 440V model

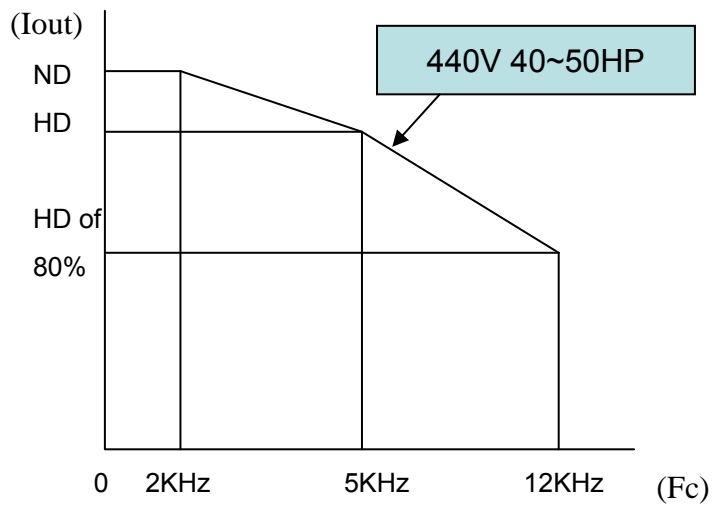
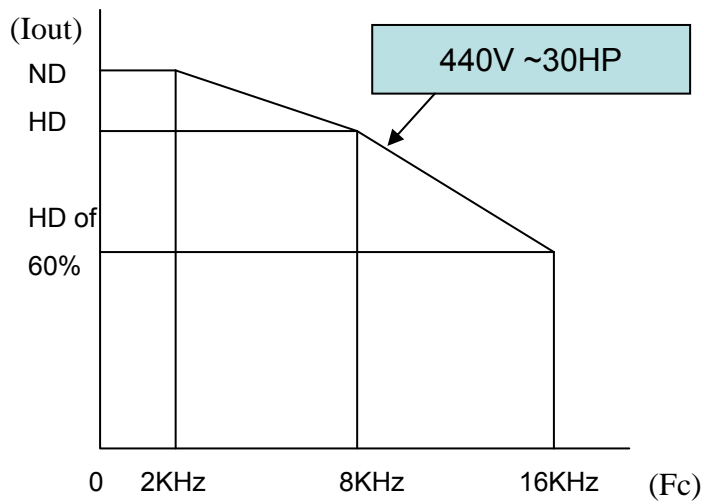

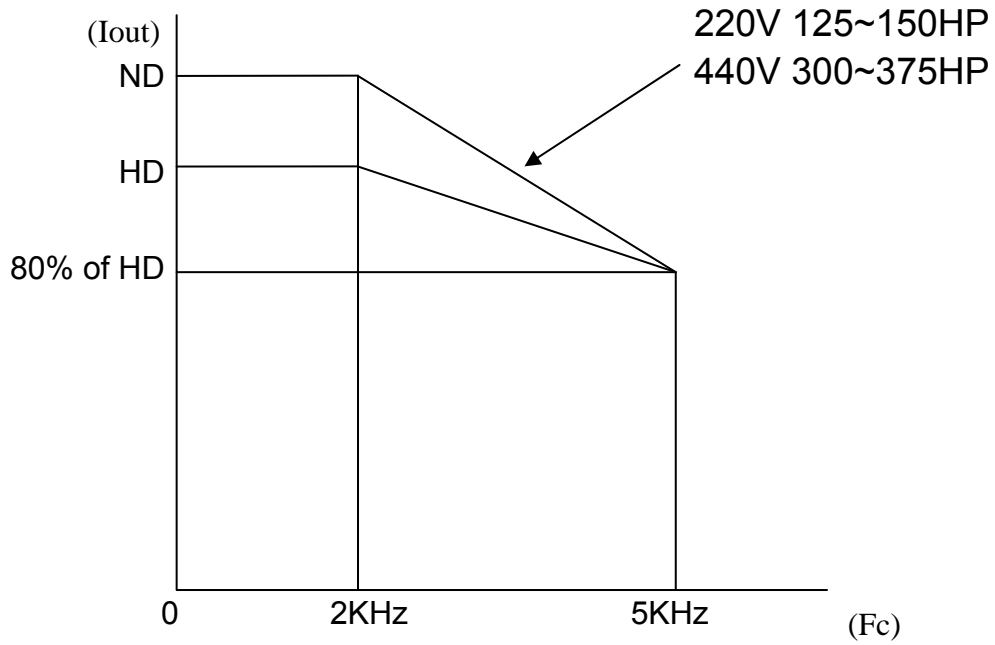
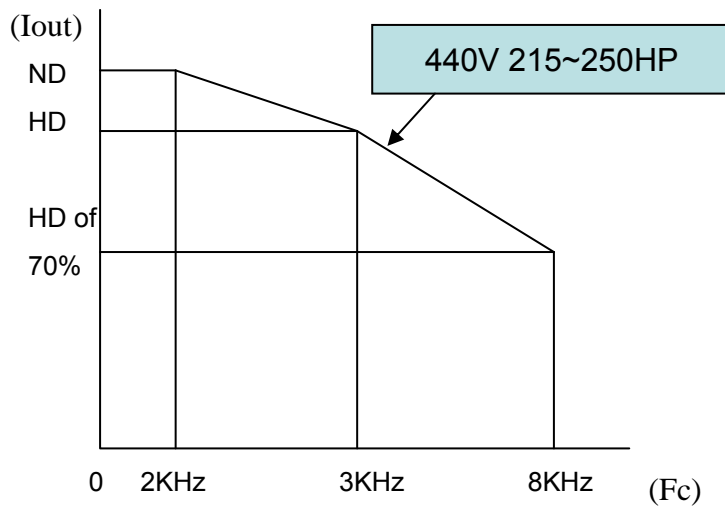
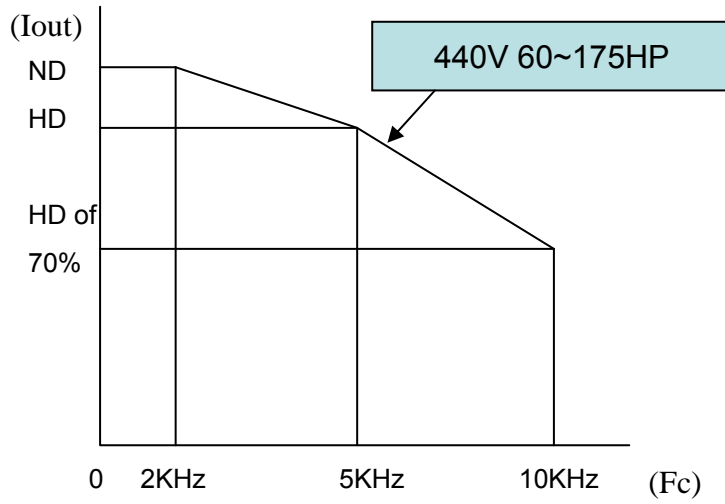

- Set the descending rated curve based on temperature

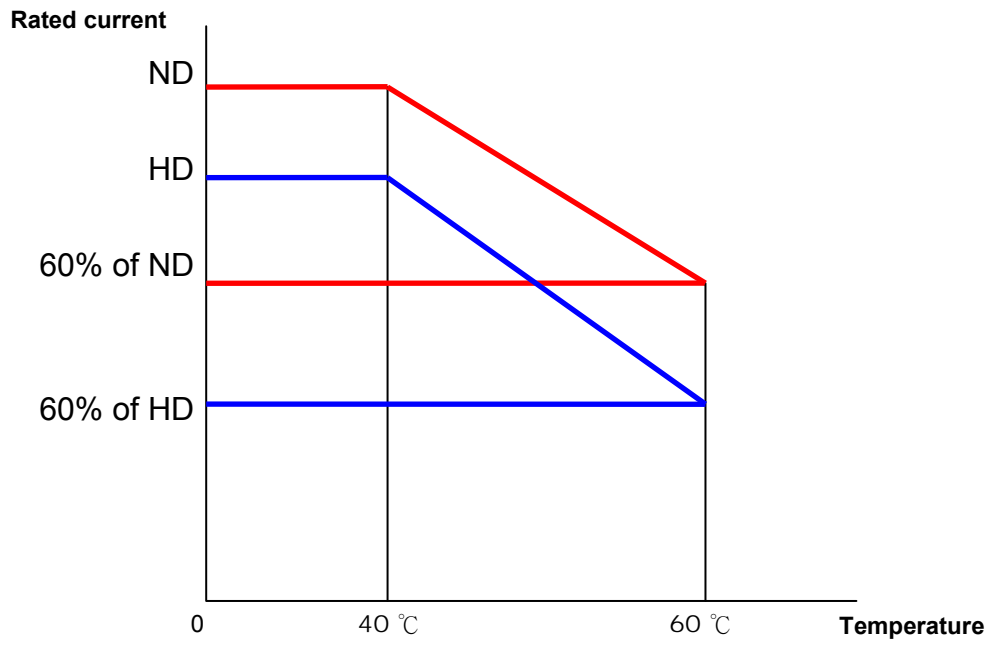

### 3.8 Overall Dimension drawing

#### 3.8.1 Standard Model

(a) 220V :1-5HP/440V :1-7.5HP

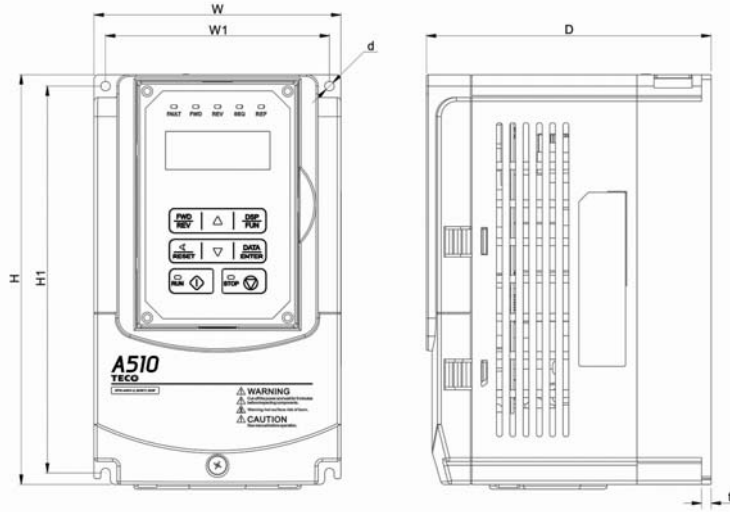

Inverter Model	Dimension (mm)								Reactor
	W	H	D	W1	H1	t	d	GW(kg)	
A510-2001-H	130	215	150	118	203	5	M5	2.2	with option DCL
A510-2002-H	130	215	150	118	203	5	M5	2.2	
A510-2003-H	140	279	177	122	267	7	M5	3.8	
A510-2005-H3	140	279	177	122	267	7	M5	3.8	
A510-4001-H3	130	215	150	118	203	5	M5	2.2	
A510-4002-H3	130	215	150	118	203	5	M5	2.2	
A510-4003-H3	130	215	150	118	203	5	M5	2.2	
A510-4005-H3	140	279	177	122	267	7	M5	3.8	
A510-4008-H3	140	279	177	122	267	7	M5	3.8	

(b) 220V :7.5-25HP/440V :10-30HP

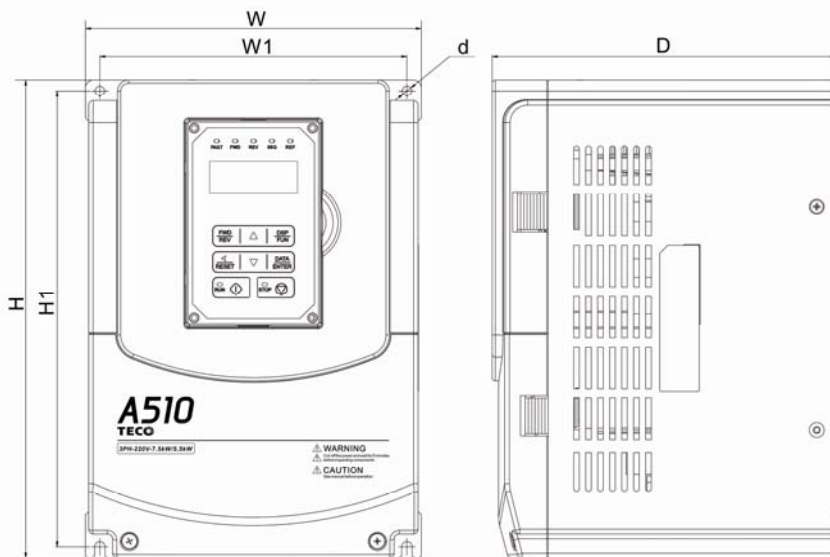



Inverter Model	Dimension (mm)								Reactor
	W	H	D	W1	H1	t	d	GW(kg)	
A510-2008-H3	210	300	215	192	286	1.6	M6	6.2	with option ACL
A510-2010-H3	210	300	215	192	286	1.6	M6	6.2	
A510-2015-H3	265	360	225	245	340	1.6	M6	10	
A510-2020-H3	265	360	225	245	340	1.6	M6	10	
A510-2025-H3	265	360	225	245	340	1.6	M6	10	
A510-4010-H3	210	300	215	192	286	1.6	M6	6.2	
A510-4015-H3	210	300	215	192	286	1.6	M6	6.2	
A510-4020-H3	265	360	225	245	340	1.6	M6	10	
A510-4025-H3	265	360	225	245	340	1.6	M6	10	
A510-4030-H3	265	360	225	245	340	1.6	M6	10	

(c) 220V :30-40HP/440V :40-60HP

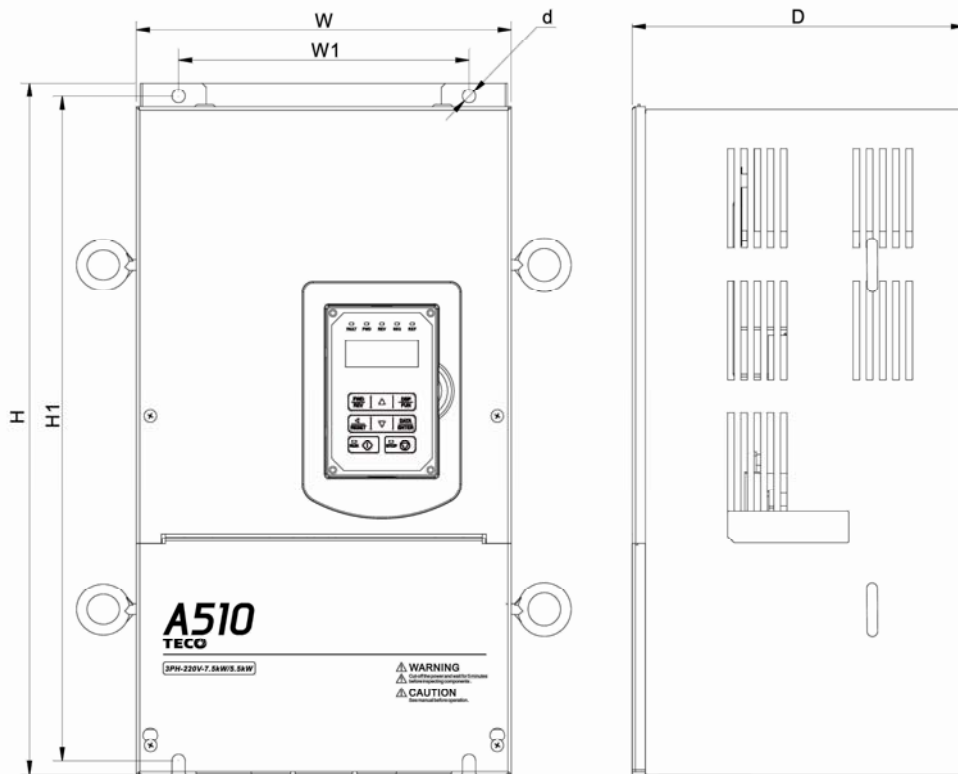

Inverter Model	Dimension (mm)								Reactor
	W	H	D	W1	H1	t	d	GW(kg)	
A510-2030-H3	284	525	252	220	505	1.6	M8	30	with option ACL
A510-2040-H3	284	525	252	220	505	1.6	M8	30	
A510-4040-H3	284	525	252	220	505	1.6	M8	30	
A510-4050-H3	284	525	252	220	505	1.6	M8	30	
A510-4060-H3	284	525	252	220	505	1.6	M8	30	

(d) 220V :50-100HP/440V :75-215HP(IP00)

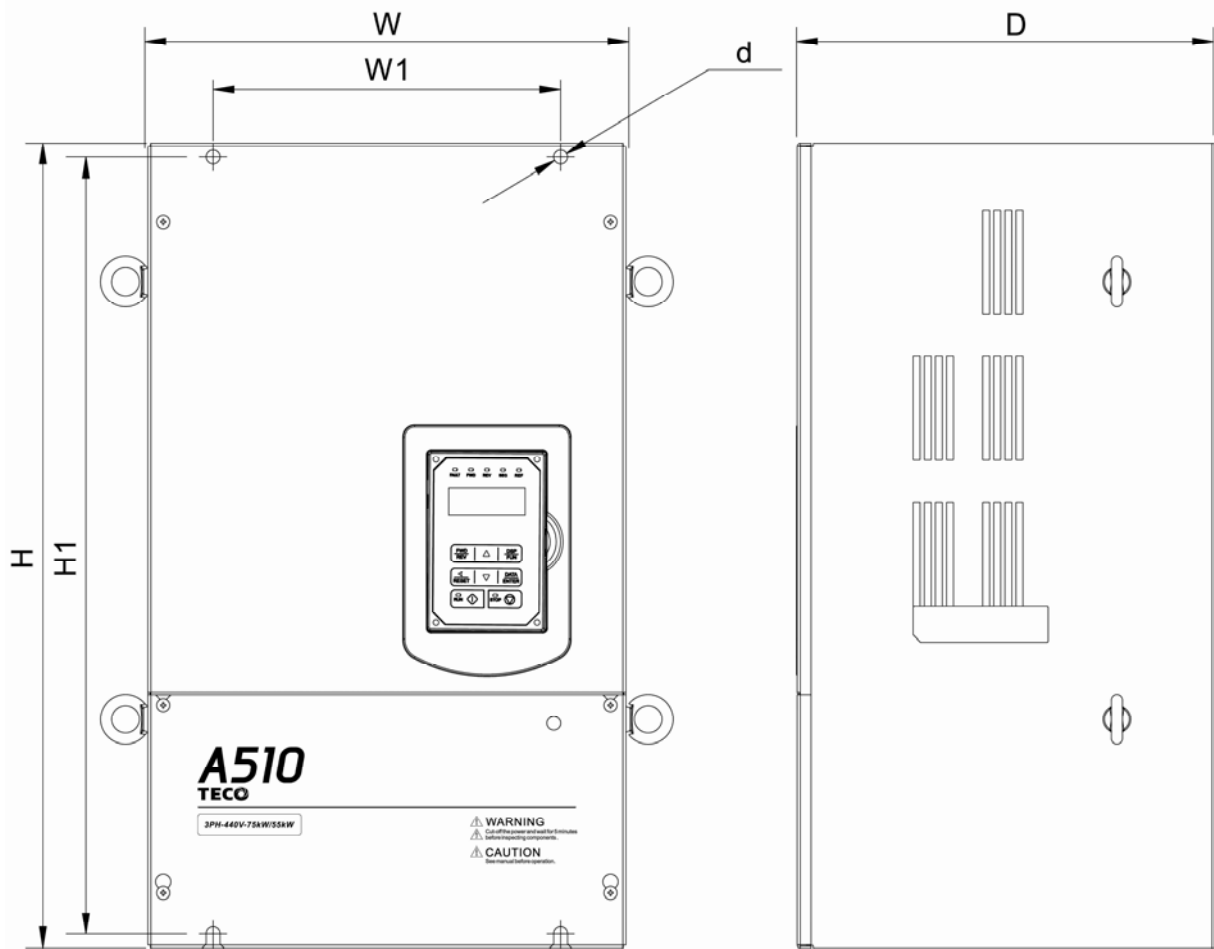

Inverter Model	Dimension (mm)								Reactor
	W	H	D	W1	H1	t	d	GW(kg)	
A510-2050-H3	344	580	300	250	560	1.6	M8	40.5	DCL STANDARD INCLUDED
A510-2060-H3	344	580	300	250	560	1.6	M8	40.5	
A510-2075-H3	459	790	324.5	320	760	1.6	M10	74	
A510-2100-H3	459	790	324.5	320	760	1.6	M10	74	
A510-4075-H3	344	580	300	250	560	1.6	M8	40.5	
A510-4100-H3	344	580	300	250	560	1.6	M8	40.5	
A510-4125-H3	459	790	324.5	320	760	1.6	M10	74	
A510-4150-H3	459	790	324.5	320	760	1.6	M10	74	
A510-4175-H3	459	790	324.5	320	760	1.6	M10	74	
A510-4215-H3	459	790	324.5	320	760	1.6	M10	74	

(e) 220V :50-100HP/440V :75-215HP(IP20)

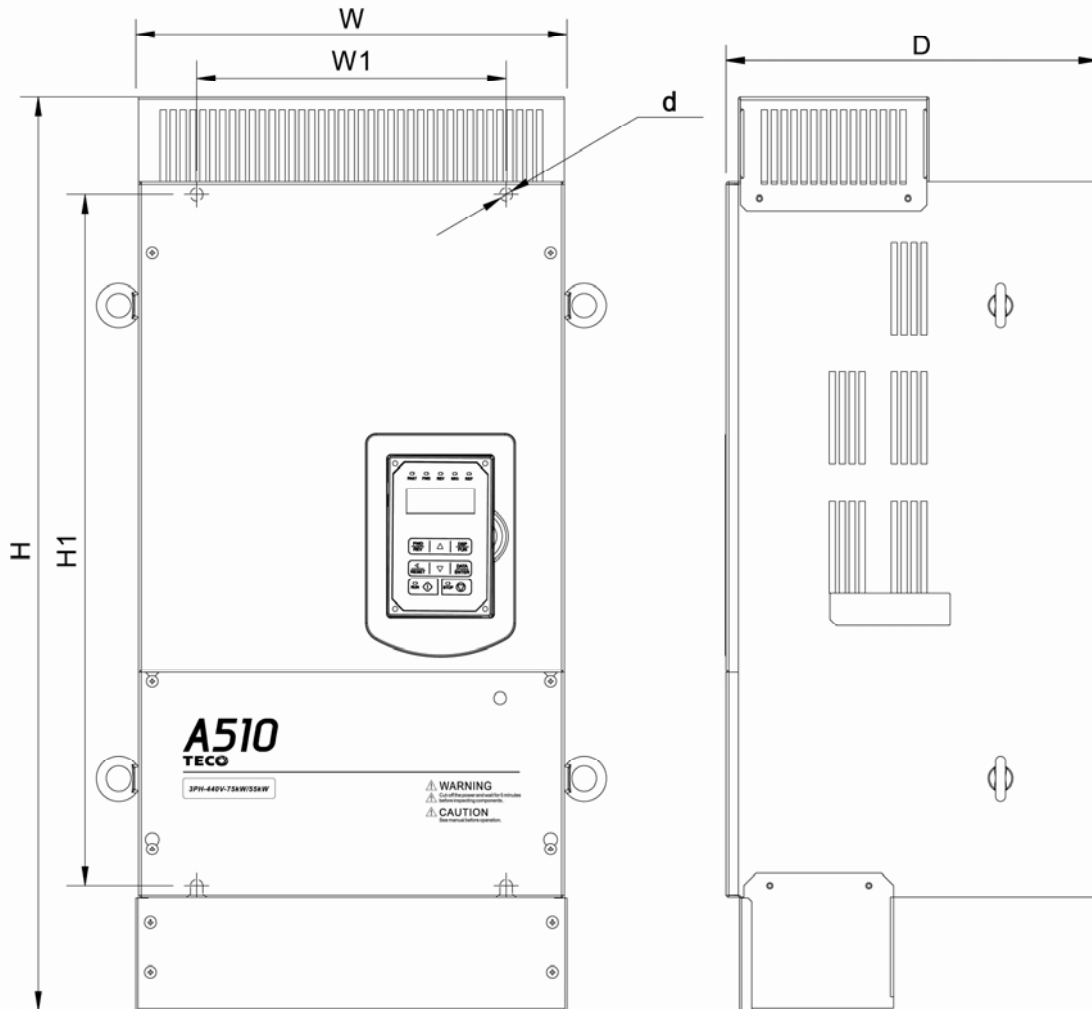

Inverter Model	Dimension (mm)								Reactor
	W	H	D	W1	H1	t	d	GW(kg)	
A510-2050-H3	348.5	740	300	250	560	1.6	M8	44	DCL STANDARD INCLUDED
A510-2060-H3	348.5	740	300	250	560	1.6	M8	44	
A510-2075-H3	463.5	1105	324.5	320	760	1.6	M10	81	
A510-2100-H3	463.5	1105	324.5	320	760	1.6	M10	81	
A510-4075-H3	348.5	740	300	250	560	1.6	M8	44	
A510-4100-H3	348.5	740	300	250	560	1.6	M8	44	
A510-4125-H3	463.5	1105	324.5	320	760	1.6	M10	81	
A510-4150-H3	463.5	1105	324.5	320	760	1.6	M10	81	
A510-4175-H3	463.5	1105	324.5	320	760	1.6	M10	81	
A510-4215-H3	463.5	1105	324.5	320	760	1.6	M10	81	

Note: 250HP or above are being developed

### 3.8.2 Built-in filter model (440V 1~60HP)

(a) 440V :1-7.5HP

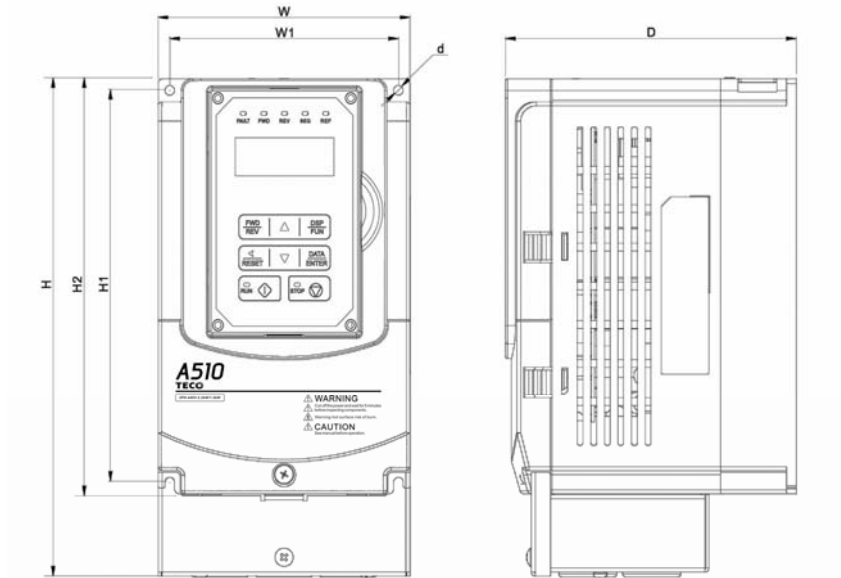

Inverter Model	Dimension (mm)									Reactor
	W	H	D	W1	H1	H2	t	d	GW(kg)	
A510-4001-H3F	130	265	150	118	203	215	5	M5	2.83	with option ACL
A510-4002-H3F	130	265	150	118	203	215	5	M5	2.83	
A510-4003-H3F	130	265	150	118	203	215	5	M5	2.83	
A510-4005-H3F	140	349	177	124	266	279	7	M5	4.72	
A510-4008-H3F	140	349	177	124	266	279	7	M5	4.72	

(b) 440V :10-30HP

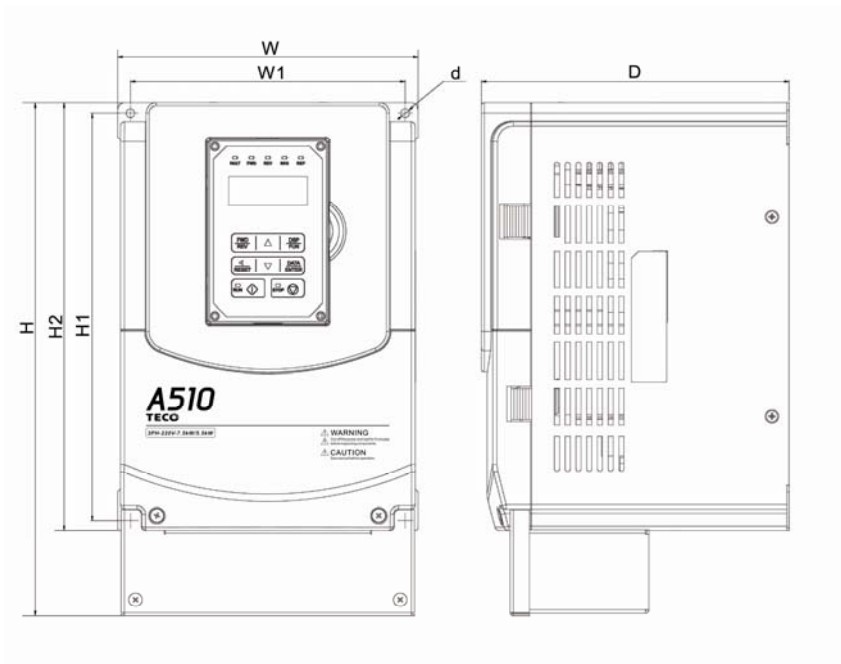

Inverter Model	Dimension (mm)									Reactor
	W	H	D	W1	H1	H2	t	d	GW(kg)	
A510-4010-H3F	210	385	215	192	286	300	1.6	M6	7.72	with option DCL
A510-4015-H3F	210	385	215	192	286	300	1.6	M6	7.72	
A510-4020-H3F	265	480	225	245	340	360	1.6	M6	11.6	
A510-4025-H3F	265	480	225	245	340	360	1.6	M6	11.6	
A510-4030-H3F	265	480	225	245	340	360	1.6	M6	11.6	

(c) 440V :40-60HP

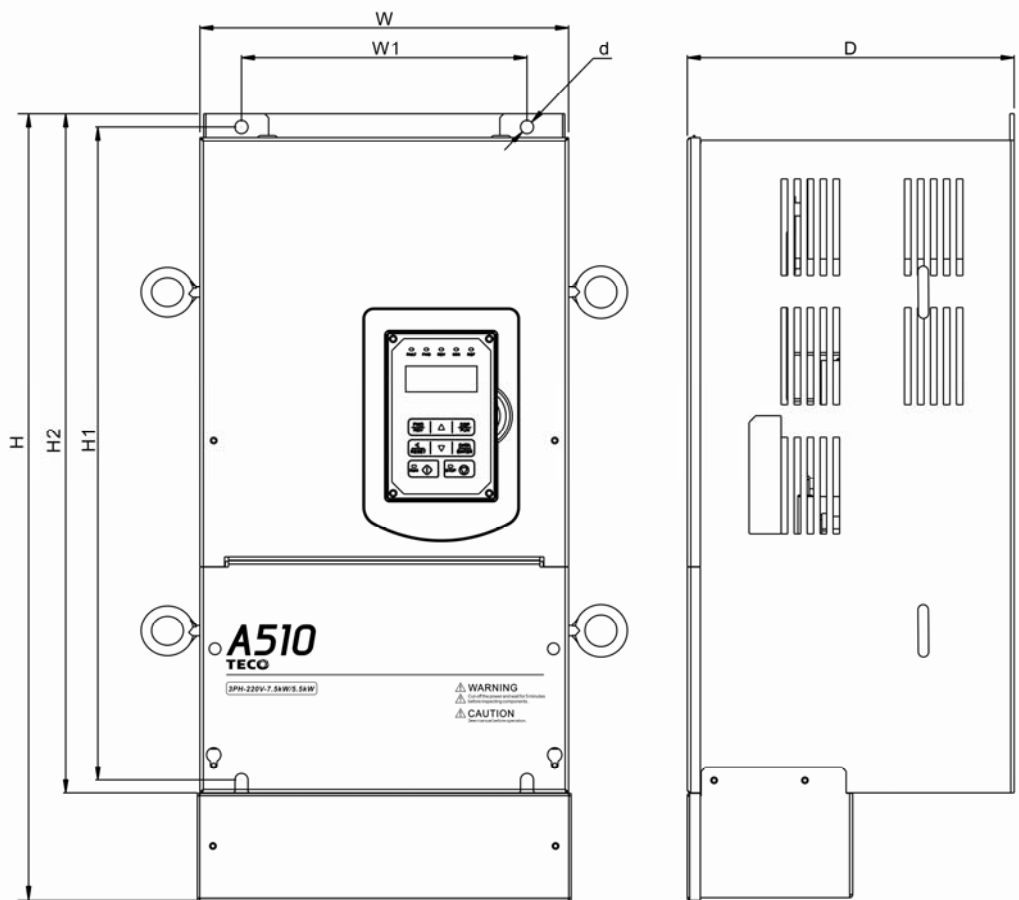

Inverter Model	Dimension (mm)									Reactor
	W	H	D	W1	H1	H2	t	d	GW(kg)	
A510-4040-H3F	284	695	252	220	505	525	1.6	M8	32.24	with option ACL
A510-4050-H3F	284	695	252	220	505	525	1.6	M8	32.24	
A510-4060-H3F	284	695	252	220	505	525	1.6	M8	32.24	

# Chapter 4 Software Index

## 4.1 Keypad Description

### 4.1.1 Panel Functions



Type	Name	Functions
Display	Main display area	Display frequency, parameter voltage, current, temperature and abnormality and ect.
	LED status display	<p><b>FAULT:</b> When the inverter has a warning or fault message, the indicator lights up.</p> <p><b>FWD:</b> When the inverter is in forward rotation status, the indicator lights up. (long bright light while inverter running, flicker while inverter stopping)</p> <p><b>REV:</b> When the inverter is in reversal rotation status, the indicator lights up. (long bright light while inverter running, flicker while inverter stopping)</p> <p><b>SEQ:</b> When inverter's run command source is set to external control, the indicator lights up.</p> <p><b>REF:</b> When inverter's frequency command source is set to external control, the indicator lights up.</p>
Keys ( 8 keys )	<b>RUN</b>	<b>RUN:</b> Enable the inverter run operation.
	<b>STOP</b>	<b>STOP:</b> Enable the inverter stop operation.
	<b>▲</b>	It is used for frequency and parameter setting.
	<b>▼</b>	It is used for frequency and parameter setting.
	<b>FWD/REV</b>	This key is used for switching motor's rotation direction. FWD indicator on means the motor is rotating in forward direction; REV indicator on means the motor is rotating in reversal direction.
	<b>DSP/FUN</b>	It is use for switching dispay interface, based on the loop of frequency screen →function selection→monitor parameter→frequency screen.
	<b>&lt;/RESET</b>	"<" is left shift key. It is used for changing parameter or value. RESET key : when a fault is detected, it plays reset function .
	<b>READ/ENTER</b>	Switch to enter the functions and set internal value, as well as modify parameter setting and confirm the writing.

## 4.1.2 Display Description

### Digital and letter display

Actual	LED Display	Actual	LED Display	Actual	LED Display	Actual	LED Display
0		A		L		Y	
1		B		n		-	
2		C		o		°	
3		D		P		—	
4		E		q		.	
5		F		r			
6		G		s			
7		H		t			
8		I		u			
9		J		v			

### Description of seven-segment display

Actual output frequency

LED lights on



Display mode of frequency command

LED flashes

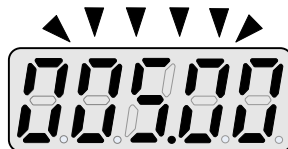











Modification mode of frequency command  
Position the flashing location  
( change the position )

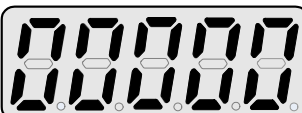





**In Idle status:** Seven-segment LED display is for frequency setting, all LEDs are flashing. If UP / DOWN key is pressed, it will enter the modification mode and the user can change the frequency command. The flashing position will change according to the </> / RESET key. Press READ / ENTER key to write frequency command and switch to the status of frequency display mode. If the READ / ENTER key is not pressed within 5 seconds under frequency modification mode, it will switch back to frequency display mode.

**In operating status:** Seven-segment LED shows the actual output frequency, its LED is constant lighting. If UP / DOWN key is pressed, it will enter the frequency command modification mode. The flashing position will change according to the </> / RESET key. If the inverter is in operation, after press READ / ENTER key to write frequency command, it switches immediately to the status of actual output frequency display mode.







## LED display

Seven-segment display	Description
	<ol style="list-style-type: none"> <li>1. Display the set frequency in idle status.</li> <li>2. Display the actual output frequency in operation status.</li> </ol>
	Display parameter code
	Display the setting value of parameter
	Display input voltage
	Display inverter current.
	Display DC Bus Voltage
	Display temperature
	Display PID feedback value. The displayed digit is set by 12-01.
	Error display, refer to Chapter 5 Troubleshooting and maintenance
	Display AI1 / AI2 input (0~100%)

## Description of indicator lighting and flashing

	Lighting		flashing	
	Manual identification		Manual identification	
Light of displaying fault	 FAULT	Lighted on when fault occurred		
FWD Indicating light	 FWD	Lighted on in forward operation status	 FWD	It will flash when it doesn't operate under the forward command.
REV Indicating light	 REV	Lighted on in reversal operation status	 REV	It will flash when it doesn't operate under the reversal command.



Indicating light of operation command by external control	 SEQ	Lighted on when the operation command is set to external control.		
Indicating light of frequency command by external control	 REF	Lighted on when the frequency command is set to external control.		
Indicating light of operation	 RUN	Lighted on under operation status	 RUN	It will flash in idle status.
Indicating light of stop	 STOP	Lighted on under stop status	 STOP	It will flash in DC braking process.

### 4.1.3 Functional structure of LED seven-segment display

Basic displays are shown as below:

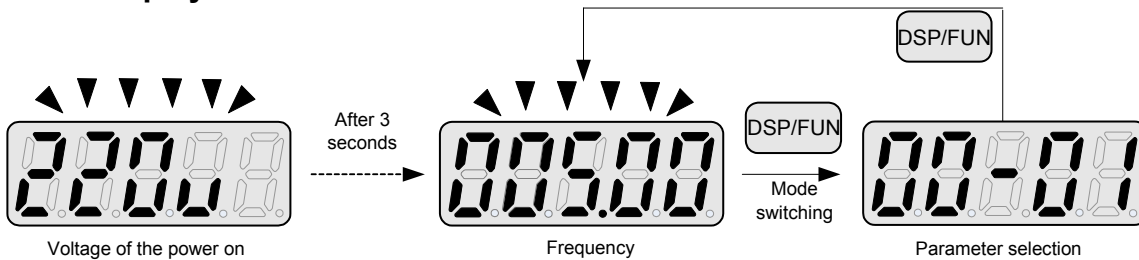

Displays set by users are as below:

12-00	Display selection				
	<u>0</u>	<u>0</u>	<u>0</u>	<u>0</u>	<u>0</u>
	Highest bit		Lowest bit		
Range	The setting range for each bit is 0~7 from the highest bit to the lowest bit.				
	【0】 : No display		【1】 : Output current		
	【2】 : Output voltage		【3】 : DC voltage		
	【4】 : Temperature		【5】 : PID feedback		
	【6】 : AI1 value		【7】 : AI2 value		

The highest bit of 12-00 presents the default boot screen, while the other bits present the display screen set by users.

Example 1: set 12-00=【10000】

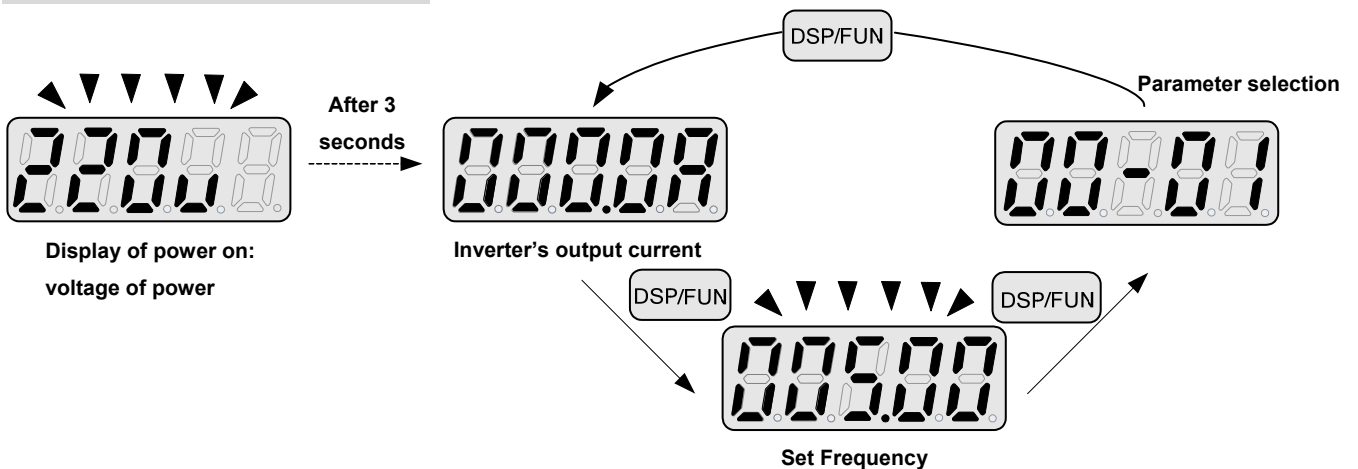

**Example 2: set 12- 00= [12345]**

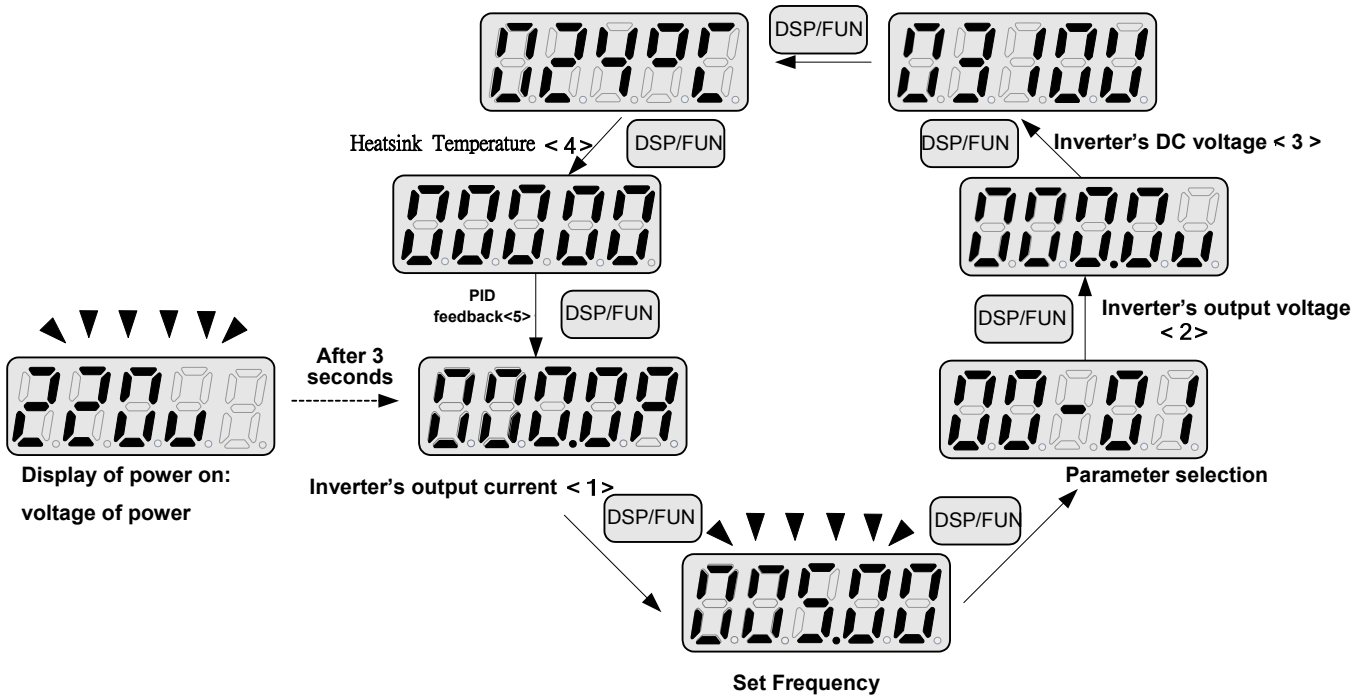

**Description of special keys**

1. "▲key" / "▼key" :

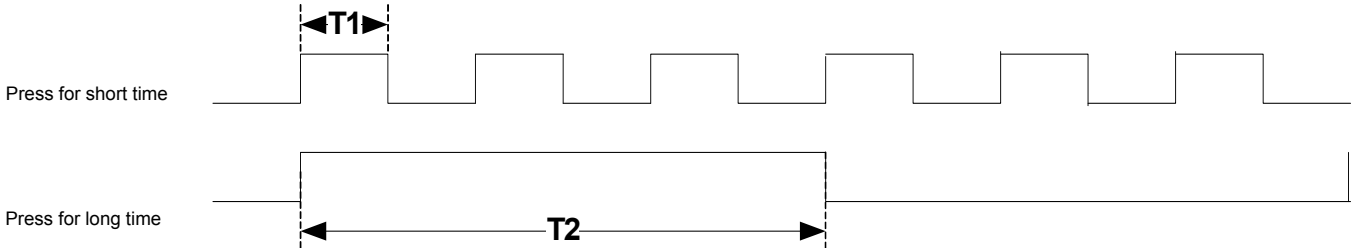

Press it for short time to position the bit location, which only changes unitage; press it for long time, the digit changes continuously.

## 4.1.4 Example of keypad operation

### Example 1: Modifying Parameters

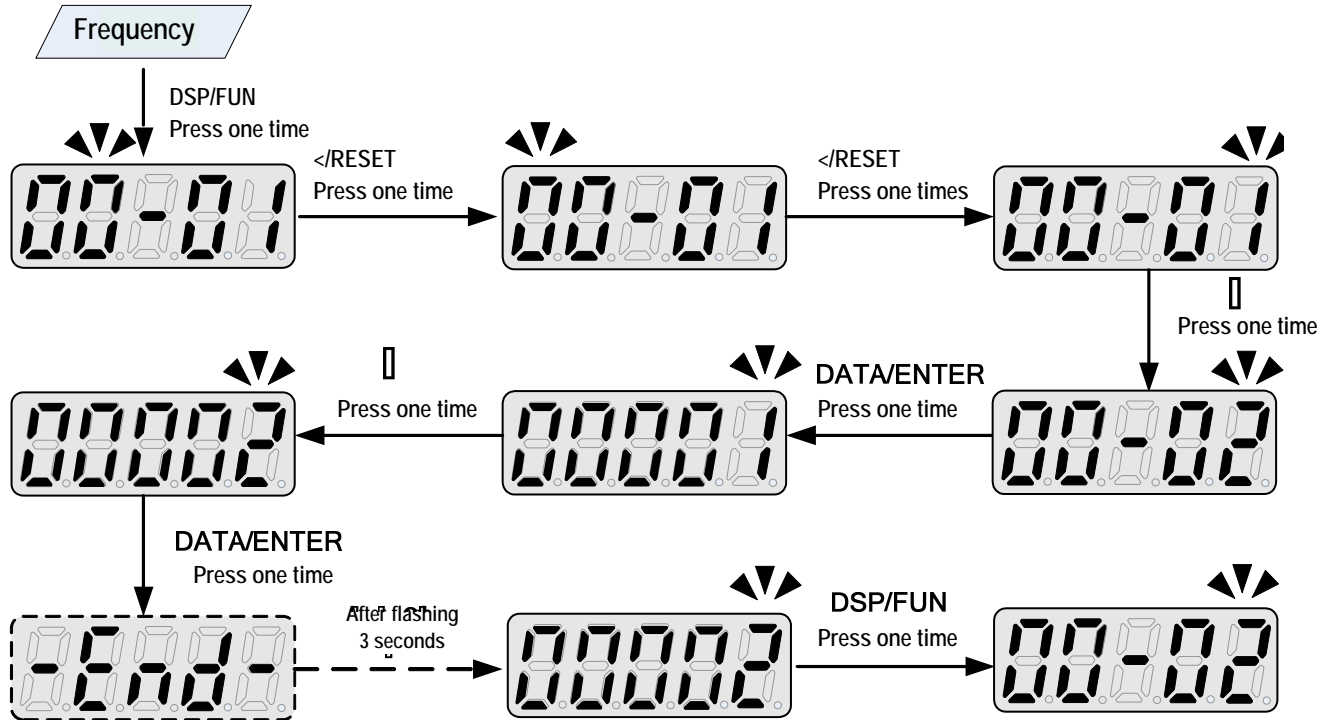

## Example 2: Modify the frequency while running and stopping with keypad.

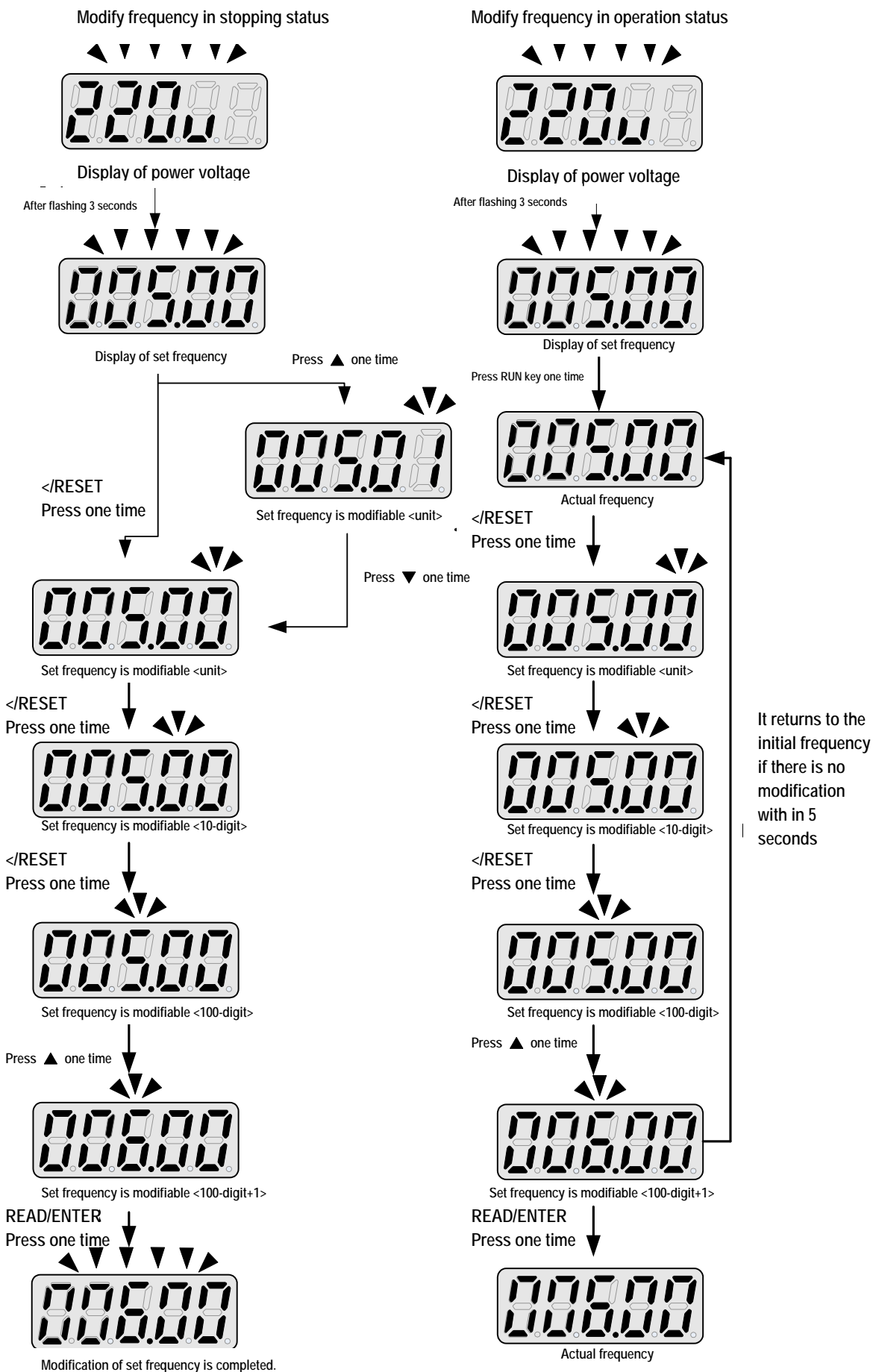

**Note:** When modify frequency by panel in idle status, frequency increased by pressing “▲ key” exceeds the upper limit will turn to the lower limit of frequency. If frequency decreased by

pressing “▼ key” is lower than the lower limit of frequency, it will turn to the upper limit of frequency.

### 4.1.5 Operation Control

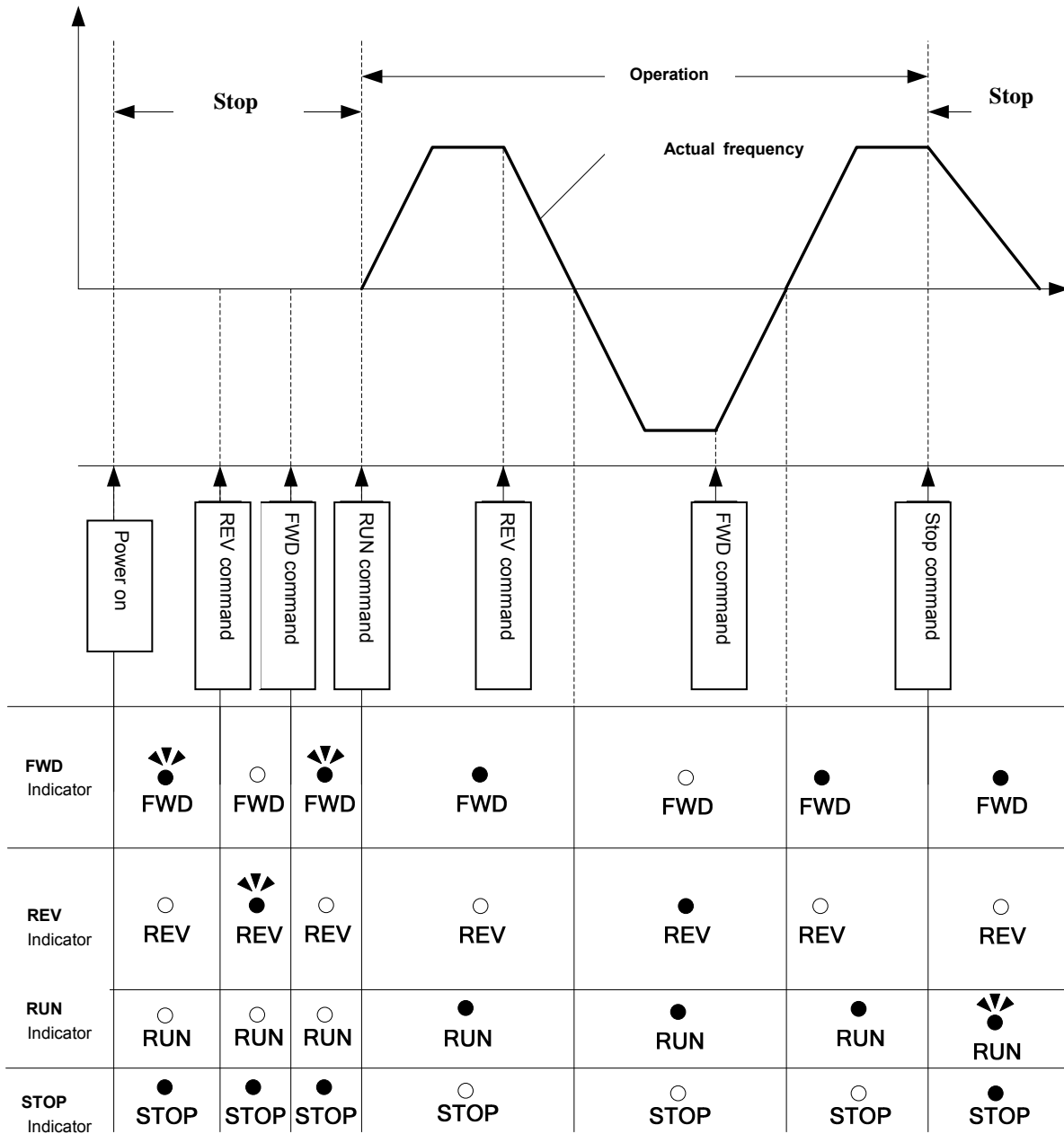

## 4.2 Parameters list

Parameter group	Name
<b>Group00</b>	Basic Function Group
<b>Group01</b>	<b>V/F</b> Control Function Group
<b>Group02</b>	<b>IM</b> Motor Parameter Group
<b>Group03</b>	External Terminals Digital Input/Output Function Group
<b>Group04</b>	External terminal analog signal input (output) function group
<b>Group05</b>	Multi-Speed Group
<b>Group06</b>	Automatic Programm Operation Function Group
<b>Group07</b>	Operation /Stop Function Group
<b>Group08</b>	Protection Function Group
<b>Group09</b>	Communication Function Group
<b>Group10</b>	<b>PID</b> Function Group
<b>Group11</b>	Auxiliary Function Group
<b>Group12</b>	Monitoring Function Group
<b>Group13</b>	Maintenance Function Group
<b>Group14</b>	<b>PLC</b> Setting Group
<b>Group15</b>	<b>PLC</b> Monitoring Group
<b>Group16</b>	<b>LCM</b> Function Group
<b>Group17</b>	Automatic Tuning Function Group
<b>Group18</b>	Slip Compensation Group
<b>Group19</b>	Frequency Wobble Function Group
<b>Group20</b>	Speed Control Function Group
<b>Group21</b>	Torque And Position Control Function Group
<b>Group22</b>	<b>IPM</b> Motor Parameter Group

Parameter Attribute	
*1	Modifiable paramters in operation
*2	Unmodifiable parameters in communication
*3	When carry out the factory default setting, this parameter value(set by users) will not restore the factory default.
*4	Readable and unmodifiable parameter

Group 00 Basic Function Group											
Code	Parameter Name	Range	Default	Unit	Control mode						Attribute
					V/F	V/F+PG	SLV	SV	PM SV	PM SLV	
00-00	Control mode Selection	0: V/F	0	-	0	0	0	0	0	0	*3
		1: V/F+PG									
		2: SLV									
		3: SV									
		4: PMSV									
5:retain											
00-01	Motor's rotation direction	0:forward direction	0	-	0	0	0	0	0	0	*1
		1:reversal direction									
00-02	RUN Command Selection	0:keypad control	1	-	0	0	0	0	0	0	
		1: external control									
		2: Communication control									
		3:PLC									
00-03	Retain										
00-04	Retain										
00-05	Main Frequency Command Source Selection	0: keypad	1	-	0	0	0	0	0	0	
		1: external control (Analog)									
		2:Terminal UP/DOWN									
		3: Communication control									
		4:pulse input									
5:PID											
00-06	Retain										
00-07	Retain										
00-08	Communication frequency command	0.00-400.00 0.0~1200.0 (when 00-31 = 1)	0.00	Hz	0	0	0	0	0	0	
00-09	Frequency command memory mode	0:Don't save when power supply is cut.	0	-	0	0	0	0	0	0	
		1: Save when power is off.									
00-10	Retain										
00-11	Retain										
00-12	Upper frequency limit	0.1~109.0	100.0	%	0	0	0	0	0	0	
00-13	Lower frequency limit	0.0~109.0	0.0	%	0	0	0	0	0	0	
00-14	Acceleration time 1	0.1~6000.0	10.0	s	0	0	0	0	0	0	*1
00-15	Deceleration time 1	0.1~6000.0	10.0	s	0	0	0	0	0	0	*1
00-16	Acceleration time 2	0.1~6000.0	10.0	s	0	0	0	0	0	0	*1
00-17	Deceleration time 2	0.1~6000.0	10.0	s	0	0	0	0	0	0	*1
00-18	Jog frequency	0.00~400.00	6.00	Hz	0	0	0	0	0	0	*1
		0.0~1200.0 (when 00-31 = 1)									
00-19	Jog acceleration time	0.1~0600.0	10.0	s	0	0	0	0	0	0	*1
00-20	Jog deceleration time	0.1~0600.0	10.0	s	0	0	0	0	0	0	*1
00-21	Acceleration time 3	0.1~6000.0	10.0	s	0	0	0	0	0	0	*1
00-22	Deceleration time 3	0.1~6000.0	10.0	s	0	0	0	0	0	0	*1
00-23	Acceleration time 4	0.1~6000.0	10.0	s	0	0	0	0	0	0	*1
00-24	Deceleration time 4	0.1~6000.0	10.0	S	0	0	0	0	0	0	*1
00-25	Switching frequency of acceleration and deceleration	0.0~400.0	0.0	Hz	0	0	0	0	0	0	
		0.0~1200.0 (when 00-31 = 1)									

Code	Parameter Name	Range	Default	Unit	Control mode						Attribute
					V/F	V/F+PG	SLV	SV	PM SV	PM SLV	
00-26	Emergency stop time	0.1~6000.0	5.0	s	O	O	O	O	O	O	
00-27	HD/ND selection	0: HD (heavy load mode)	0	-	O	O	X	X	X	X	*3
		1: ND (general load mode)									
00-28	Command characteristic selection of master frequency	0: positive characteristic (0~10V/4~20mA is corresponding to 0~100%)	0	-	O	O	O	O	O	O	
		1: negative characteristic (0~10V/4~20mA is corresponding to 100~0%)									
00-29	Zero-speed operation selection	0: Operation based on frequency command	0	-	X	X	X	O	O	X	
		1: Stop									
		2: Operation based on the lowest frequency									
		3: Zero-speed operation									
00-30	Retain										
00-31	Maximum frequency	0: 400.00Hz	0	-	O	O	X	X	X	X	*3
		1: 1200.0Hz									
00-32	Application adjustment	0: Disable	0	-	O	O	O	O	O	O	
		1: Water supply pump									
		2: Conveyor									
		3: Exhaust fan									
		4: HVAC									
		5: Compressor									
		6: Hoist									
		7: Crane									

Group 01 V/F Control Function Group											
Code	Parameter Name	Range	Default	Unit	Control mode						Attribute
					V/F	V/F+PG	SLV	SV	PM SV	PM SLV	
01-00	V/F curve selection	0~FF	F	-	O	O	X	X	X	X	*3
01-01	Retain										
01-02	Maximum output frequency of motor 1	40.0~400.0	60.0	Hz	O	O	O	O	O	O	
		40.0~1200.0 (when 00-31 = 1)									
01-03	Maximum output voltage of motor 1	200V: 0.1~255.0	220.0	V	O	O	X	X	X	X	
		400V: 0.2~510.0									
01-04	Middle Output frequency 2 of motor 1	0.0~400.0	0.0	Hz	O	O	X	X	X	X	
		0.0~1200.0 (when 00-31 = 1)									
01-05	Middle Output voltage 2 of motor 1	200V: 0.0~255.0	0.0	V	O	O	X	X	X	X	
		400V: 0.0~510.0									
01-06	Middle Output frequency 1 of motor 1	0.0~400.0	3.0	Hz	O	O	X	X	X	X	
		0.0~1200.0 (when 00-31 = 1)									
01-07	Middle Output voltage 1 of motor 1	200V: 0.0~255.0	14.0	V	O	O	X	X	X	X	
		400V: 0.0~510.0									



Code	Parameter Name	Range	Default	Unit	Control mode						Attribute
					V/F	V/F +PG	SLV	SV	PM SV	PM SLV	
01-08	Minimum output frequency of motor 1	0.0~400.0 0.0~1200.0 (when 00-31 = 1 )	1.5	Hz	O	O	O	O	O	O	
01-09	Minimum output voltage of motor 1	200V: 0.0~255.0	7.5	V	O	O	X	X	X	X	
		400V: 0.0~510.0	15.0								
01-10	Torque compensation gain	0.0~2.0	1.0	-	O	O	X	X	X	X	*1
01-11	Retain										
01-12	Base frequency of motor 1	10.0~400.0 10.0~1200.0 (when 00-31 = 1)	60.0	Hz	O	O	O	O	O	O	
01-13	Base output voltage of motor 1	200V: 0.0~255.0	220.0	V	O	O	X	X	X	X	
		400V: 0.0~510.0	440.0								
01-14	Input voltage setting	200V: 155.0~255.0	220.0	V	O	O	O	O	O	O	
		400V: 310.0~510.0	440.0								
01-15	Torque compensation time	1~10000	200	ms	O	O	X	X	X	X	
01-16	Maximum output frequency of motor 2	40.0~400.0 40.0~1200.0 (when 00-31 = 1)	60.0	Hz	O	O	O	O	O	O	
01-17	Maximum output voltage of motor 2	200V: 0.1~255.0	220.0	V	O	O	X	X	X	X	
		400V: 0.2~510.0	440.0								
01-18	Middle Output frequency 2 of motor 2	0.0~400.0 0.0~1200.0 (when 00-31 = 1)	0.0	Hz	O	O	X	X	X	X	
01-19	Middle Output voltage 2 of motor 2	200V: 0.0~255.0	0.0	V	O	O	X	X	X	X	
		400V: 0.0~510.0									
01-20	Middle output frequency 1 of motor 2	0.0~400.0 0.0~1200.0 (when 00-31 = 1)	3.0	Hz	O	O	X	X	X	X	
01-21	Middle output voltage 1 of motor 2	200V: 0.0~255.0	14.0	V	O	O	X	X	X	X	
		400V: 0.0~510.0	28.0								
01-22	Minimum output frequency of motor 2	0.0~400.0 0.0~1200.0 (when 00-31 = 1)	1.5	Hz	O	O	O	O	O	O	
01-23	Minimum output voltage of motor 2	200V: 0.0~255.0	7.5	V	O	O	X	X	X	X	
		400V: 0.0~510.0	15.0								
01-24	Base frequency of motor 2	10.0~400.0 10.0~1200.0 (when 00-31 = 1)	60.0	Hz	O	O	O	O	O	O	
01-25	Base output voltage of motor 2	200V: 0.0~255.0	220.0	V	O	O	X	X	X	X	
		400V: 0.0~510.0	440.0								

Group 02 IM Motor parameter group											
Code	Parameter Name	Range	Default	Unit	Control mode						Attribute
					V/F	V/F+PG	SLV	SV	PM SV	PM SLV	
02-00	No-Load Current of motor1	0.01~600.00	-	A	O	X	X	X	X	X	
02-01	Rated current of motor1	Modes of V/F, V/F+PG are 10%~200% of inverter's rated current. Modes of SLV, SV are 25%~200% of inverter's rated current.	-	A	O	O	O	O	X	X	
02-02	Retain										
02-03	Rated rotation speed of motor1	0~60000	-	Rpm	O	O	O	O	X	X	
02-04	Rated voltage of motor1	200V: 50.0~240.0	220.0	V	O	O	O	O	X	X	
		400V: 100.0~480.0	440.0								
02-05	Rated power of motor1	0.01~600.00	-	kW	O	O	O	O	X	X	
02-06	Rated frequency of motor1	10.0~400.0 10.0~1200.0 (when 00-31 = 1)	60.0	Hz	O	O	O	O	X	X	
02-07	Poles of motor 1	2,4,6,8	4	-	O	O	O	O	X	X	
02-08	Retain										
02-09	Excitation current of motor 1	10.0~100.0	-	%	X	X	O	O	X	X	
02-10	Core saturation coefficient 1 of motor 1	0~100	-	%	X	X	O	O	X	X	
02-11	Core saturation coefficient 2 of motor 1	0~100	-	%	X	X	O	O	X	X	
02-12	Core saturation coefficient 3 of motor 1	80~300	-	%	X	X	O	O	X	X	
02-13	Core loss of motor 1	0.0~15.0	-	%	O	O	X	X	X	X	
02-14	Retain										
02-15	Resistance between wires of motor 1	0.001~60.000	-	Ω	O	O	O	O	X	X	
02-16	Rotor resistance of motor 1	0.001~60.000	-	Ω	X	X	O	O	X	X	
02-17	Leakage inductance of motor 1	0.01~200.00	-	mH	X	X	O	O	X	X	
02-18	Mutual inductance of motor 1	0.1~6553.5	-	mH	X	X	O	O	X	X	
02-19	No-Load Voltage of motor 1	200V: 50~240	-	V	X	X	O	O	X	X	
		400V: 100~480	-								
02-20	No-Load Current of motor2	0.01~600.00	-	A	O	X	X	X	X	X	
02-21	Rated current of motor 2	10%~200% of inverter's rated current	-	A	O	O	O	O	X	X	
02-22	Rated rotation speed of motor 2	0~60000	-	Rpm	O	O	O	O	X	X	
02-23	Rated voltage of motor 2	200V: 50.0~240.0	220.0	V	O	O	O	O	X	X	
		400V: 100.0~480.0	440.0								
02-24	Rated power of motor 2	0.01~600.00	-	kW	O	O	O	O	X	X	

Code	Parameter Name	Range	Default	Unit	Control mode						Attribute
					V/F	V/F +PG	SLV	SV	PM SV	PM SLV	
02-25	Rated frequency of motor 2	10.0~400.0 10.0~1200.0 (when 00-31 = 1)	60.0	Hz	○	○	○	○	X	X	
02-26	Poles of motor 2	2,4,6,8	4	-	○	○	○	○	X	X	
02-27		Retain									
02-28		Retain									
02-29		Retain									
02-30		Retain									
02-31		Retain									
02-32	Resistance between wires of motor 2	0.001~60.000	-	Ω	○	○	○	○	X	X	
02-33		Retain									
02-34		Retain									
02-35		Retain									
02-36		Retain									

**Group 03 External terminal digital signal input (output) function group**

Code	Parameter Name	Range	Default	Unit	Control mode						Attribute
					V/F	V/F +PG	SLV	SV	PM SV	PM SLV	
03-00	Multi-function terminal Function setting-S1	0: 2-Wire sequence (ON : Forward run command).	0	-	○	○	○	○	○	○	
03-01	Multi-function terminal Function setting-S2	1: 2-Wire sequence (ON : Reverse run command).	1	-	○	○	○	○	○	○	
03-02	Multi-function terminal Function setting-S3	2: Multi-speed/position setting command 1	8	-	○	○	○	○	○	○	
03-03	Multi-function terminal Function setting-S4	3: Multi-speed/position setting command 2	9	-	○	○	○	○	○	○	
03-04	Multi-function terminal Function setting-S5	4: Multi-speed/position setting command 3	2	-	○	○	○	○	○	○	
03-05	Multi-function terminal Function setting-S6	5: Multi-speed/position setting command 4	17	-	○	○	○	○	○	○	
03-06	Multi-function terminal Function setting-S7	6 : Forward jog run command 7 : Reverse jog run command 8 : UP frequency increasing command	Two-wire type:29 Three-wire type:26	-	○	○	○	○	○	○	
03-07	Multi-function terminal Function setting-S8	9: DOWN frequency decreasing command 10: Acceleration/deceleration setting command 1 11: Inhibit Acceleration/deceleration Command 12: Retain 13: Retain 14: Emergency stop (decelerate to zero and stop) 15: External Baseblock Command(rotation freely to	15	-	○	○	○	○	○	○	

		stop) 16 : PID control disable 17: Fault reset (RESET) 18: Retain 19: Speed Search 1(from the maximum frequency) 20: Manual energy saving function 21: PID integral reset 22 : Retain 23 : Retain 24: PLC input 25: External fault 26: 3-Wire sequence (Forward/Reverse command). 27: Local/Remote selection 28: Remote mode selection 29: Jog frequency selection 30: Acceleration/deceleration setting command 2 31: Inverter overheating warning 32: Sync command 33: DC braking 34: Speed Search 2 (from the frequency command) 35: Timing function input 36: PID Soft start invalid 37: Traversing operation 38 : Upper Deviation of traverse operation 39 : Lower Deviation of traverse operation 40: Switching between motor 1/motor 2 41: Retain 42: PG invalid 43: PG integral reset 44: Mode switching between speed and torque 45: Negative torque command 46 : Zero-Servo Command 47: Fire Mode 48: KEB acceleration 49:Parameters writing allowable 50 : Unattended Start Protection (USP) 51: Mode switching between speed and position								
--	--	---	--	--	--	--	--	--	--	--

Code	Parameter Name	Range	Default	Unit	Control mode						Attribute
					V/F	V/F +PG	SLV	SV	PM SV	PM SLV	
03-08	(S1~S8)DI Scan time	0: Scan time 4ms 1: Scan time 8ms	1	-	0	0	0	0	0	0	
03-09	Multi-function terminal S1-S4 type selection	xxx0b: S1 A contact xxx1b: S1 B contact	0000b	-	0	0	0	0	0	0	
		xx0xb: S2 A contact xx1xb: S2 B contact									
		x0xxb: S3 A contact x1xxb: S3 B contact									
		0xxxb: S4 A contact 1xxxb: S4 B contact									
03-10	Multi-function terminal S5-S8 type selection	xxx0b: S5 A contact xxx1b: S5 B contact	0000b	-	0	0	0	0	0	0	
		xx0xb: S6 A contact xx1xb: S6 B contact									
		x0xxb: S7 A contact x1xxb: S7 B contact									
		0xxxb: S8 A contact 1xxxb: S8 B contact									
03-11	Relay (R1A-R1C) output	0: Durning Running 1: Fault contact output	1	-	0	0	0	0	0	0	
03-12	Relay (R2A-R2C) output	2: Frequency Agree 3: Setting Frequency Agree 4: Frequency detection 1 (> 03-13) 5: Frequency detection 2 (< 03-13) 6: Automatic restart 7: Retain 8: Retain 9: Baseblock 10: Retain 11: Retain 12: Over torque detection 13: Retain 14: Retain 15: Retain 16: Retain 17: Retain 18: PLC status 19: PLC control contact 20: zero speed 21: Inverter Ready 22: Undervoltage Detection 23: Source of operation command 24: Source of frequency command 25: Low torque detection 26: Frequency Reference	20	-	0	0	0	0	0	0	

		missing 27: Timing function output 28: Traverse operation UP Status 29 : During Traverse operation status 30 : Motor 2 Selection 31 : Zero Servo Completed 32: Communication control contacts										
03-13	Frequency detection Level	0.0~400.0 0.0~1200.0 (when 00-31 = 1)	0.0	Hz	○	○	○	○	○	○		
03-14	Frequency detection width	0.1~25.5	2.0	Hz	○	○	○	○	○	○		
03-15	Retain											
03-16	Retain											
03-17	Retain											
03-18	Retain											
03-19	Relay (R1A-R2C) type	xxx0b: R1 A contact xxx1b: R1 B contact xx0xb: R2 A contact xx1xb: R2 B contact	0000b	-	○	○	○	○	○	○		
03-20	Retain											
03-21	Retain											
03-22	Retain											
03-23	Retain											
03-24	Retain											
03-25	Retain											
03-26	Retain											
03-27	UP/DOWN frequency maintaining selection	0: maintain UP/DOWN frequency when stopping 1: clear UP/DOWN frequency when stopping 2: allow UP/DOWN frequency when stopping	0	-	○	○	○	○	○	○		
03-28	Optocoupler output	Range and definition are the same as those of 03-11, 03-12	0	-	○	○	○	○	○	○		
03-29	optocoupler output selection	xxx0b: optocoupler A contact xxx1b: optocoupler B contact	0000b	-	○	○	○	○	○	○		
03-30	Function setting of pulse input	0: Frequency command 1: PID feedback 2: PID target value 3: Retain	0	-	○	○	○	○	○	○		
03-31	Scale of pulse input	50~32000	1000	Hz	○	○	○	○	○	○		*1
03-32	Gain of pulse input	0.0~1000.0	100	%	○	○	○	○	○	○		*1
03-33	Bias voltage of pulse input	-100.0~100.0	0.0	%	○	○	○	○	○	○		*1
03-34	Filter time of pulse input	0.00~2.00	0.1	Sec	○	○	○	○	○	○		*1

Code	Parameter Name	Range	Default	Unit	Control mode						Attribute
					V/F	V/F +PG	SLV	SV	PM SV	PM SLV	
03-35	Function setting of pulse output	1: Frequency command	2	-	O	O	O	O	O	O	*1
		2: Output frequency									
		3: Output frequency after soft-start									
		4: motor speed									
		5: PID feedback									
		6: PID input									
		7: PG output									
03-36	Scale of pulse output	1~32000	1000	Hz	O	O	O	O	O	O	*1
03-37	Timer ON delay (DIO)	0.0~6000.0	0.0	s	O	O	O	O	O	O	
03-38	Timer OFFdelay (DIO)	0.0~6000.0	0.0	s	O	O	O	O	O	O	

**Group 04 External terminal analog signal input(output) function group**

Code	Parameter Name	Range	Default	Unit	Control mode						Attribute
					V/F	V/F +PG	SLV	SV	PM SV	PM SLV	
04-00	AI input signal type	0: AI1:0~10V AI2: 0~10V	1	-	O	O	O	O	O	O	
		1: AI1:0~10V AI2: 4~20mA									
		2: AI1: -10~10V AI2: 0~10V									
		3: AI1: -10~10V AI2: 4~20mA									
04-01	AI1 signal scanning and filtering time	0.00~2.00	0.03	s	O	O	O	O	O	O	
04-02	AI1gain value	0.0~1000.0	100.0	%	O	O	O	O	O	O	*1
04-03	AI1bias voltage value	-100.0~100.0	0	%	O	O	O	O	O	O	*1
04-04	Retain										
04-05	AI2 function setting	0: Auxiliary Frequency	10	-	O	O	O	O	O	O	
		1: Frequency Reference Gain									
		2: Frequency Reference Bias									
		3: Output Voltage Bias									
		4: Coefficient of acceleration and deceleration reduction									
		5: DC braking current									
		6: Over-torque detection level									
		7: Stall prevention Level During Running									
		8:Frequency lower limit									
		9:Jump frequency 4									
		10: Added to AI1									
		11: Positive torque limit									
		12: Negative torque limit									
		13: Regenerative Torque Limit									
		14: Positive / negative torque limit									
		15: Torque Reference/Torque Limit (in speed control)									
		16: Torque compensation									
17: No function											
04-06	AI2 signal scanning and filtering time	0.00~2.00	0.03	s	O	O	O	O	O	O	
04-07	AI2 gain value	0.0~1000.0	100.0	%	O	O	O	O	O	O	*1
04-08	AI2 bias voltage value	-100.0~100.0	0	%	O	O	O	O	O	O	*1
04-09	Retain										
04-10	Retain										
04-11	AO1 function setting	0: Output frequency	0	-	O	O	O	O	O	O	
		1: Frequency command									
		2: Output voltage									
		3: DC voltage									
		4: Output current									
		5: Output power									
		6: Motor Speed									
		7: Output power factor									
		8: AI1 input									



		9: AI2 input									
		10: Torque command									
		11: q-axis current									
		12: d-axis current									
		13: Speed deviation									
		14: Retain									
		15: ASR output									
		16: Retain									
		17: q-axis voltage									
		18: d-axis voltage									
		19: Retain									
		20: Retain									
		21: PID input									
		22: PID output									
		23: PID target value									
		24: PID feedback value									
		25: Output frequency of the soft starter									
		26: PG feedback									
		27: PG compensation volume									
04-12	AO1 gain value	0.0~1000.0	100.0	%	○	○	○	○	○	○	*1
04-13	AO1 bias-voltage value	-100.0~100.0	0	%	○	○	○	○	○	○	*1
04-14	Retain										
04-15	Retain										
04-16	AO2 function setting	Range and definition are the same as those of 04-11	3	-	○	○	○	○	○	○	
04-17	AO2 gain value	0.0~1000.0	100.0	%	○	○	○	○	○	○	*1
04-18	AO2 bias-voltage value	-100.0~100.0	0	%	○	○	○	○	○	○	*1

Group 05 Multi-Speed Group											
Code	Parameter Name	Range	Default	Unit	Control mode						Attribute
					V/F	V/F+PG	SLV	SV	PM SV	PM SLV	
05-00	Acceleration and deceleration selection of multi-speed	0: acceleration time is set by deceleration time 1~4	0	-	O	O	O	O	O	O	
		1:Acceleration and deceleration time setting respetively									
05-01	Frequency setting of speed-stage 0	0.00~400.00 0.0~1200.0 (when 00-31 = 1)	5.00	Hz	O	O	O	O	O	O	*1
05-02	Retain										
05-03	Retain										
05-04	Retain										
05-05	Retain										
05-06	Retain										
05-07	Retain										
05-08	Retain										
05-09	Retain										
05-10	Retain										
05-11	Retain										
05-12	Retain										
05-13	Retain										
05-14	Retain										
05-15	Retain										
05-16	Retain										
05-17	Acceleration time setting of multi speed 0	0.1~6000.0	10.0	s	O	O	O	O	O	O	
05-18	Deceleration time setting of multi speed 0	0.1~6000.0	10.0	s	O	O	O	O	O	O	
05-19	Acceleration time setting of multi speed 1	0.1~6000.0	10.0	s	O	O	O	O	O	O	
05-20	Deceleration time setting of multi speed 1	0.1~6000.0	10.0	s	O	O	O	O	O	O	
05-21	Acceleration time setting of multi speed 2	0.1~6000.0	10.0	s	O	O	O	O	O	O	
05-22	Deceleration time setting of multi speed 2	0.1~6000.0	10.0	s	O	O	O	O	O	O	
05-23	Acceleration time setting of multi speed 3	0.1~6000.0	10.0	s	O	O	O	O	O	O	
05-24	Deceleration time setting of multi speed 3	0.1~6000.0	10.0	s	O	O	O	O	O	O	
05-25	Acceleration time setting of multi speed 4	0.1~6000.0	10.0	s	O	O	O	O	O	O	
05-26	Deceleration time setting of multi speed 4	0.1~6000.0	10.0	s	O	O	O	O	O	O	
05-27	Acceleration time setting of multi speed 5	0.1~6000.0	10.0	s	O	O	O	O	O	O	
05-28	Deceleration time setting of multi speed 5	0.1~6000.0	10.0	s	O	O	O	O	O	O	
05-29	Acceleration time	0.1~6000.0	10.0	s	O	O	O	O	O	O	

Group 05 Multi-Speed Group											
Code	Parameter Name	Range	Default	Unit	Control mode						Attribute
					V/F	V/F+PG	SLV	SV	PM SV	PM SLV	
	setting of multi speed 6										
05-30	Deceleration time setting of multi speed 6	0.1~6000.0	10.0	s	O	O	O	O	O	O	
05-31	Acceleration time setting of multi speed 7	0.1~6000.0	10.0	s	O	O	O	O	O	O	
05-32	Deceleration time setting of multi speed 7	0.1~6000.0	10.0	s	O	O	O	O	O	O	
05-33	Acceleration time setting of multi speed 8	0.1~6000.0	10.0	s	O	O	O	O	O	O	
05-34	Deceleration time setting of multi speed 8	0.1~6000.0	10.0	s	O	O	O	O	O	O	
05-35	Acceleration time setting of multi speed 9	0.1~6000.0	10.0	s	O	O	O	O	O	O	
05-36	Deceleration time setting of multi speed 9	0.1~6000.0	10.0	s	O	O	O	O	O	O	
05-37	Acceleration time setting of multi speed 10	0.1~6000.0	10.0	s	O	O	O	O	O	O	
05-38	Deceleration time setting of multi speed 10	0.1~6000.0	10.0	s	O	O	O	O	O	O	
05-39	Acceleration time setting of multi speed 11	0.1~6000.0	10.0	s	O	O	O	O	O	O	
05-40	Deceleration time setting of multi speed 11	0.1~6000.0	10.0	s	O	O	O	O	O	O	
05-41	Acceleration time setting of multi speed 12	0.1~6000.0	10.0	s	O	O	O	O	O	O	
05-42	Deceleration time setting of multi speed 12	0.1~6000.0	10.0	s	O	O	O	O	O	O	
05-43	Acceleration time setting of multi speed 13	0.1~6000.0	10.0	s	O	O	O	O	O	O	
05-44	Deceleration time setting of multi speed 13	0.1~6000.0	10.0	s	O	O	O	O	O	O	
05-45	Acceleration time setting of multi speed 14	0.1~6000.0	10.0	s	O	O	O	O	O	O	
05-46	Deceleration time setting of multi speed 14	0.1~6000.0	10.0	s	O	O	O	O	O	O	
05-47	Acceleration time setting of multi speed 15	0.1~6000.0	10.0	s	O	O	O	O	O	O	

Group 05 Multi-Speed Group											
Code	Parameter Name	Range	Default	Unit	Control mode						Attribute
					V/F	V/F+PG	SLV	SV	PM SV	PM SLV	
05-48	Deceleration time setting of multi speed 15	0.1~6000.0	10.0	s	0	0	0	0	0	0	

Group 06 Automatic Programm Operation Function Group											
Code	Parameter Name	Range	Default	Unit	Control mode						Attribute
					V/F	V/F+PG	SLV	SV	PM SV	PM SLV	
06-00	Automatic operation mode selection	0: invalid	0	-	0	0	0	0	X	0	X
		1: Execute a single cycle operation mode. Restart speed is based on the previous stopped speed.									
		2: Execute continuous cycle operation mode. Restart speed is based on the previous stopped speed.									
		3: After the completion of a single cycle, the on-going operation speed is based on the speed of the last stage. Restart speed is based on the previous stopped speed.									
		4: Execute a single cycle operation mode. Restart speed will be based on the speed of stage 1.									
		5: Execute continuous cycle operation mode. Restart speed will be based on the speed of stage 1.									
		6: After the completion of a single cycle, the on-going operation speed is based on the speed of the last stage. Restart speed is based on the previous stopped speed.									
06-01	Frequency setting of speed-stage 1	0.00~400.00 0.0~1200.0 (when 00-31 = 1)	5.00	Hz	0	0	0	0	0	0	*1
06-02	Frequency setting of speed-stage 2	0.00~400.00 0.0~1200.0 (when 00-31 = 1)	10.00	Hz	0	0	0	0	0	0	*1
06-03	Frequency setting of speed-stage 3	0.00~400.00 0.0~1200.0 (when 00-31 = 1)	20.00	Hz	0	0	0	0	0	0	*1
06-04	Frequency setting of speed-stage 4	0.00~400.00 0.0~1200.0 (when 00-31 = 1)	30.00	Hz	0	0	0	0	0	0	*1
06-05	Frequency setting of speed-stage 5	0.00~400.00 0.0~1200.0 (when 00-31 = 1)	40.00	Hz	0	0	0	0	0	0	*1

**Group 06 Automatic Programm Operation Function Group**

Code	Parameter Name	Range	Default	Unit	Control mode						Attribute
					V/F	V/F +PG	SLV	SV	PM SV	PM SLV	
06-06	Frequency setting of speed-stage 6	0.00~400.00 0.0~1200.0 (when 00-31 = 1)	50.00	Hz	O	O	O	O	O	O	*1
06-07	Frequency setting of speed-stage 7	0.00~400.00 0.0~1200.0 (when 00-31 = 1)	50.00	Hz	O	O	O	O	O	O	*1
06-08	Frequency setting of speed-stage 8	0.00~400.00 0.0~1200.0 (when 00-31 = 1)	5.00	Hz	O	O	O	O	O	O	*1
06-09	Frequency setting of speed-stage 9	0.00~400.00 0.0~1200.0 (when 00-31 = 1)	5.00	Hz	O	O	O	O	O	O	*1
06-10	Frequency setting of speed-stage 10	0.00~400.00 0.0~1200.0 (when 00-31 = 1)	5.00	Hz	O	O	O	O	O	O	*1
06-11	Frequency setting of speed-stage 11	0.00~400.00 0.0~1200.0 (when 00-31 = 1)	5.00	Hz	O	O	O	O	O	O	*1
06-12	Frequency setting of speed-stage12	0.00~400.00 0.0~1200.0 (when 00-31 = 1)	5.00	Hz	O	O	O	O	O	O	*1
06-13	Frequency setting of speed-stage 13	0.00~400.00 0.0~1200.0 (when 00-31 = 1)	5.00	Hz	O	O	O	O	O	O	*1
06-14	Frequency setting of speed-stage 14	0.00~400.00 0.0~1200.0 (when 00-31 = 1)	5.00	Hz	O	O	O	O	O	O	*1
06-15	Frequency setting of speed-stage 15	0.00~400.00 0.0~1200.0 (when 00-31 = 1)	5.00	Hz	O	O	O	O	O	O	*1
06-16	Operation time setting of speed-stage 0	0.0~6000.0	0.0	s	O	O	O	X	X	O	*1
06-17	Operation time setting of speed-stage 1	0.0~6000.0	0.0	s	O	O	O	X	X	O	*1
06-18	Operation time setting of speed-stage 2	0.0~6000.0	0.0	s	O	O	O	X	X	O	*1
06-19	Operation time setting of speed-stage 3	0.0~6000.0	0.0	s	O	O	O	X	X	O	*1
06-20	Operation time setting of speed-stage 4	0.0~6000.0	0.0	s	O	O	O	X	X	O	*1
06-21	Operation time setting of speed-stage 5	0.0~6000.0	0.0	s	O	O	O	X	X	O	*1
06-22	Operation time setting of speed-stage 6	0.0~6000.0	0.0	s	O	O	O	X	X	O	*1
06-23	Operation time setting of speed-stage 7	0.0~6000.0	0.0	s	O	O	O	X	X	O	*1
06-24	Operation time setting of speed-stage 8	0.0~6000.0	0.0	s	O	O	O	X	X	O	*1
06-25	Operation time setting of speed-stage 9	0.0~6000.0	0.0	s	O	O	O	X	X	O	*1
06-26	Operation time setting of speed-stage 10	0.0~6000.0	0.0	s	O	O	O	X	X	O	*1
06-27	Operation time setting of speed-stage 11	0.0~6000.0	0.0	s	O	O	O	X	X	O	*1
06-28	Operation time setting of speed-stage 12	0.0~6000.0	0.0	s	O	O	O	X	X	O	*1
06-29	Operation time setting of speed-stage 13	0.0~6000.0	0.0	s	O	O	O	X	X	O	*1

**Group 06 Automatic Programm Operation Function Group**

Code	Parameter Name	Range	Default	Unit	Control mode						Attribute
					V/F	V/F +PG	SLV	SV	PM SV	PM SLV	
06-30	Operation time setting of speed-stage 14	0.0~6000.0	0.0	s	O	O	O	X	X	O	*1
06-31	Operation time setting of speed-stage 15	0.0~6000.0	0.0	s	O	O	O	X	X	O	*1
06-32	Operation direction selection of speed-stage 0	0: Stop 1: Forward 2: Reversal	0	-	O	O	O	X	X	O	
06-33	Operation direction selection of speed-stage 1	0: Stop 1: Forward 2: Reversal	0	-	O	O	O	X	X	O	
06-34	Operation direction selection of speed-stage2	0: Stop 1: Forward 2: Reversal	0	-	O	O	O	X	X	O	
06-35	Operation direction selection of speed-stage 3	0: Stop 1: Forward 2: Reversal	0	-	O	O	O	X	X	O	
06-36	Operation direction selection of speed-stage 4	0: Stop 1: Forward 2: Reversal	0	-	O	O	O	X	X	O	
06-37	Operation direction selection of speed-stage 5	0: Stop 1: Forward 2: Reversal	0	-	O	O	O	X	X	O	
06-38	Operation direction selection of speed-stage 6	0: Stop 1: Forward 2: Reversal	0	-	O	O	O	X	X	O	
06-39	Operation direction selection of speed-stage 7	0: Stop 1: Forward 2: Reversal	0	-	O	O	O	X	X	O	
06-40	Operation direction selection of speed-stage 8	0: Stop 1: Forward 2: Reversal	0	-	O	O	O	X	X	O	
06-41	Operation direction selection of speed-stage 9	0: Stop 1: Forward 2: Reversal	0	-	O	O	O	X	X	O	
06-42	Operation direction selection of speed-stage 10	0: Stop 1: Forward 2: Reversal	0	-	O	O	O	X	X	O	
06-43	Operation direction selection of speed-stage 11	0: Stop 1: Forward 2: Reversal	0	-	O	O	O	X	X	O	
06-44	Operation direction selection of speed-stage 12	0: Stop 1: Forward 2: Reversal	0	-	O	O	O	X	X	O	
06-45	Operation direction selection of speed-stage13	0: Stop 1: Forward 2: Reversal	0	-	O	O	O	X	X	O	
06-46	Operation direction selection of	0: Stop 1: Forward 2: Reversal	0	-	O	O	O	X	X	O	

**Group 06 Automatic Programm Operation Function Group**

Code	Parameter Name	Range	Default	Unit	Control mode						Attribute	
					V/F	V/F+PG	SLV	SV	PM SV	PM SLV		
	speed-stage 14											
06-47	Operation direction selection of speed-stage 15	0: Stop 1: Forward 2: Reversal	0	-	0	0	0	X	X	0		

**Group 07 Start /Stop Function Group**

Code	Parameter Name	Range	Default	Unit	Control mode						Attribute	
					V/F	V/F+PG	SLV	SV	PM SV	PM SLV		
07-00	Momentary stop and restart selection	0:invalid 1:valid	0	-	0	0	0	0	0	0		
07-01	Restart time of automatic reset	0~7200	0	s	0	0	0	0	0	0		
07-02	Times of automatic reset	0~10	0	-	0	0	0	0	0	0		
07-03	Retain											
07-04	Retain											
07-05	Retain											
07-06	DC Injection Braking Starting Frequency	0.0~10.0	0.5	Hz	0	0	0	0	X	X		
07-07	DC Injection Braking Current	0~100	50	%	0	0	0	0	X	X		
07-08	DC Injection Braking Time at Stop	0.00~10.00	0.50	s	0	0	0	0	X	X		
07-09	Stop mode selection	0: Deceleration to stop 1: Coast to stop 2: DC braking stop in all fields 3: Coast to stop with timer	0	-	0	0	0	0	0	0		
07-10	Retain											
07-11	Retain											
07-12	Retain											
07-13	Low voltage Detection Level	200V: 150~210 400V: 300~420	190 380	V	0	0	0	0	0	0		
07-14	Maximum pre-excitation time	0.00~10.00	2.00	s	X	X	0	X	X	X		
07-15	Pre-excitation Level	100~200	100	%	X	X	0	X	X	X		
07-16	DC Injection Braking Time at Start	0.00~10.00	0.00	s	0	0	0	0	0	0		
07-17	Retain											
07-18	Minimum Base block Time	0.1~5.0	-	Sec	0	0	0	X	X	0		
07-19	Speed Direction Search Operating Current	0~100	50	%	0	X	0	X	X	0		
07-20	Speed Search Operating Current	0~100	20	%	0	X	0	X	X	0		
07-21	Integral time of speed	0.1~10.0	2.0	Sec	0	X	0	X	X	0		

Group 07 Start /Stop Function Group												
Code	Parameter Name	Range	Default	Unit	Control mode						Attribute	
					V/F	V/F+PG	SLV	SV	PM SV	PM SLV		
	searching											
07-22	Delay time of speed searching	0.0~20.0	0.2	Sec	O	O	O	O	O	O		
07-23	Voltage Recovery Time	0.1~5.0	2.0	Sec	O	O	O	O	O	O		
07-24	Bidirection Speed Search Selection	0:invalid	0	-	O	O	O	X	X	O		
		1:valid										
07-25	Low voltage Detection Time	0.00~1.00	0.00	Sec	O	O	O	O	O	O		
07-26	Mechanical braking selection	0:invalid	0	-	X	X	O	X	X	O		
		1:valid										

Group 08 Protection Function Group												
Code	Parameter Name	Range	Default	Unit	Control mode						Attribute	
					V/F	V/F+PG	SLV	SV	PM SV	PM SLV		
08-00	Stall prevention function	xxx0b: Stall prevention is valid in acceleration.	0000b	-	O	O	O	O	X	O		
		xxx1b: Stall prevention is invalid in acceleration.										
		xx0xb: Stall prevention is valid in deceleration.										
		xx1xb: Stall prevention is invalid in deceleration.										
		x0xxb: Stall prevention is valid in operation										
		x1xxb: Stall prevention is invalid in operation										
		0xxxb: Stall prevention in operation is based on deceleration time of speed-stage 1.										
		1xxxb: Stall prevention in operation is based on deceleration time of speed-stage 2.										
08-01	Stall prevention level in acceleration	30~200	HD:150 ND:120	%	O	O	O	X	X	O		
08-02	Stall prevention level in deceleration	200V: 330~410	395	V	O	O	O	X	X	O		
		400V: 660~820	790									
08-03	Stall prevention level in operation	30~200	HD:160 ND:120	%	O	O	O	X	X	O		
08-04	Retain											



Code	Parameter Name	Range	Default	Unit	Control mode						Attribute
					V/F	V/F+PG	SLV	SV	PM SV	PM SLV	
08-05	Selection for motor overload protection (OL1)	xxx0b: Motor overload is invalid.	0001b	-	O	O	O	O	O	O	
		xxx1b: Motor overload is valid.									
		xx0xb: Cold start of motor overload									
		xx1xb: Hot start of motor overload									
		x0xxb: Standard motor									
		x1xxb: Inverter motor									
		0xxxb: Retain									
1xxxb: Retain											
08-06	Start-up mode of overload protection operation (OL1)	0: stop output after overload protection	0	-	O	O	O	O	O	O	
		1: Continuous operation after overload protection.									
08-07	Retain										
08-08	Automatic voltage regulation (AVR)	0: Valid	0	-	O	O	O	O	O	O	
		1: Invalid									
08-09	Selection of input phase loss protection	0: Invalid	0	-	O	O	O	O	O	O	
		1: Valid									
08-10	Selection of output phase loss protection	0: Invalid	0	-	O	O	O	O	O	O	
		1: Valid									
08-11	Retain										
08-12	Retain										
08-13	Selection of over-torque detection	0: Over-torque detection is invalid.	0	-	O	O	O	O	O	O	
		1: Start to detect when reaching the set frequency.									
		2: Start to detect when the operation is begun.									
08-14	Selection of over-torque operation	0: Deceleration to stop when over torque is detected.	0	-	O	O	O	O	O	O	
		1: Display warning when over torque is detected. Go on operation.									
08-15	Level of over-torque detection	0~300	150	%	O	O	O	O	O	O	
08-16	Time of over-torque detection	0.0~10.0	0.1	Sec	O	O	O	O	O	O	
08-17	Selection of low-torque detection	0: Low-torque detection is invalid.	0	-	O	O	O	O	O	O	
		1: Start to detect when reaching the set frequency.									
		2: Start to detect when the operation is begun.									
08-18	Selection of low-torque operation	0: Deceleration to stop when low torque is detected.	0	-	O	O	O	O	O	O	

		1: Display warning when low torque is detected. Go on operation.										
08-19	Level of low-torque detection	0~300	150	%	O	O	O	O	O	O		
08-20	Time of low-torque detection	0.0~10.0	0.1	Sec	O	O	O	O	O	O		
08-21	Limit of stall prevention in acceleration	0~100	50	%	O	O	O	X	X	O		
08-22	Stall prevention detection time in operation	2~100	100	ms	O	O	O	X	X	O		
08-23	Ground Fault Selection	0: invalid 1: valid	0	-	O	O	O	O	O	O		
08-24	External Fault Operation Selection	0: Deceleration to stop 1: Coast to stop 2: continuous operation	0	-	O	O	O	O	O	O		
08-25	Detection selection of external fault	0: Immediately detect when the power is supplied. 1: Start to detect when the operation is started.	0	-	O	O	O	O	O	O		
08-26	Retain											
08-27	Retain											
08-28	Retain											
08-29	Retain											
08-30	Retain											

Group 09 Communication Function Group											
Code	Parameter Name	Range	Default	Unit	Control mode						Attribute
					V/F	V/F+PG	SLV	SV	PM SV	PM SLV	
09-00	INV Communication Station Address	1~31	1	-	O	O	O	O	O	O	*2
09-01	Retain										
09-02	Baud rate setting	0:1200	3	-	O	O	O	O	O	O	*2
		1:2400									
		2:4800									
		3:9600									
		4:19200									
09-03	Stop bit selection	0: 1 stop bit 1: 2 stop bit	0	-	O	O	O	O	O	O	*2
09-04	Parity selection	0: No Parity	0	-	O	O	O	O	O	O	*2
		1: even bit									
		2: odd bit									
09-05	Retain										

Code	Parameter Name	Range	Default	Unit	Control mode						Attribute
					V/F	V/F+PG	SLV	SV	PM SV	PM SLV	
09-06	Communication error detection time	0.0~25.5	0.0	S	0	0	0	0	0	0	
09-07	Fault stop selection	0: Deceleration to stop based on deceleration time 1 when communication fault occurs.	3	-	0	0	0	0	0	0	0
		1: Coast to stop when communication fault occurs.									
		2: Deceleration to stop based on deceleration time 2 when communication fault occurs.									
		3: Keep operating when communication fault occurs.									
09-08	Retain										
09-09	Waiting time	5~65	5	ms	0	0	0	0	0	0	

Group 10 PID Function Group											
Code	Parameter Name	Range	Default	Unit	Control mode						Attribute
					V/F	V/F+PG	SLV	SV	PM SV	PM SLV	
10-00	PID target value source setting (00-05=5 this parameter is enabled)	1:AI1 given	1	-	0	0	0	0	0	0	0
		2:AI2 given									
		3:Retain									
		4:10-02 given									
10-01	PID feedback value source setting	1:AI1 given	2	-	0	0	0	0	0	0	0
		2:AI2 given									
		3:Retain									
10-02	PID target value	0.0~100.0	0.0	%	0	0	0	0	0	0	
10-03	PID control mode	xxx0b: PID invalid	0000b	-	0	0	0	0	0	0	0
		xxx1b: PID valid									
		xx0xb: PID positive characteristic									
		xx1xb: PID negative characteristic									
		x0xxb: PID error value of D control									
		x1xxb: PID feedback value of D control									
		0xxxb: PID output									
1xxxb: PID output + target value											
10-04	Feedback gain	0.01~10.00	1.00	-	0	0	0	0	0	0	*1
10-05	Proportional gain (P)	0.00~10.00	1.00	-	0	0	0	0	0	0	*1
10-06	Integral time (I)	0.0~100.0	1.00	s	0	0	0	0	0	0	*1
10-07	Differential time(D)	0.00~10.00	0.00	s	0	0	0	0	0	0	*1
10-08	Retain										
10-09	PID bias voltage	-100.0~100.0	0	%	0	0	0	0	0	0	*1

Group 10 PID Function Group											
Code	Parameter Name	Range	Default	Unit	Control mode						Attribute
					V/F	V/F+PG	SLV	SV	PM SV	PM SLV	
10-10	PID Primary Delay Time	0.00~10.00	0.00	s	○	○	○	○	○	○	*1
10-11	PID Feedback Loss Detection Selection	0: Invalid	0	-	○	○	○	○	○	○	
		1: Warning									
		2: Fault									
10-12	PID Feedback Loss Detection Level	0~100	0	%	○	○	○	○	○	○	
10-13	PID Feedback Loss Detection Time	0.0~10.0	1.0	s	○	○	○	○	○	○	
10-14	PID integral limit	0.0~100.0	100.0	%	○	○	○	○	○	○	*1
10-15	Retain										
10-16	Retain										
10-17	Start frequency of PID sleep	0.00~180.00	0.00	Hz	○	○	○	○	○	○	
10-18	Delay time of PID sleep	0.0~255.5	0.0	s	○	○	○	○	○	○	
10-19	Frequency of PID waking up	0.00~180.00	0.00	Hz	○	○	○	○	○	○	
10-20	Delay time of PID waking up	0.0~255.5	0.0	s	○	○	○	○	○	○	
10-21	Retain										
10-22	Retain										
10-23	PID limit	0.00~100.0	100.0	%	○	○	○	○	○	○	*1
10-24	PID output gain	0.0~25.0	1.0	-	○	○	○	○	○	○	
10-25	PID reversal output selection	0: No allowing reversal output	0	-	○	○	○	○	○	○	
		1: Allow reversal output									
10-26	PID target acceleration/deceleration time	0.0~25.5	0.0	s	○	○	○	○	○	○	
10-27	PID feedback display bias	-99.99~99.99	0.00	-	○	○	○	○	○	○	
10-28	PID feedback display gain	0.00~99.99	1.00	-	○	○	○	○	○	○	
10-29	PID sleep selection	0: invalid	1	-	○	○	○	○	○	○	
		1: valid									
		2: set by DI									

Group 11 Auxiliary Function Group											
Code	Parameter Name	Range	Default	Unit	Control mode						Attribute
					V/F	V/F+PG	SLV	SV	PM SV	PM SLV	
11-00	Direction Lock Selection	0: Allow forward and reverse rotation	0	-	O	O	O	O	O	O	
		1: Only allow forward rotation									
		2: Only allow reverse rotation									
11-01	Carrier frequency	<b>【0】</b> : carrier output frequency tuning <b>【1】</b> : Retain <b>【2~16】</b> KHz	Determined by horse power (HP) value	-	O	O	O	O	O	O	
11-02	Soft PWM Function Selection	0: invalid	0	-	O	O	O	O	O	O	
		1: valid									
11-03	Automatic carrier lowering selection	0: invalid	0	-	O	O	X	X	X	X	
		1: valid									
11-04	S curve time setting at the start of acceleration	0.00~2.50	0.00	s	O	O	O	O	O	O	
11-05	S curve time setting at the end of acceleration	0.00~2.50	0.00	s	O	O	O	O	O	O	
11-06	S curve time setting at the start of deceleration	0.00~2.50	0.00	s	O	O	O	O	O	O	
11-07	S curve time setting at the end of deceleration	0.00~2.50	0.00	s	O	O	O	O	O	O	
11-08	Jump frequency 1	0.0~400.0 0.0~1200.0 (when 00-31 = 1 )	0.0	Hz	O	O	O	O	O	O	
11-09	Jump frequency 2	0.0~400.0 0.0~1200.0 (when 00-31 = 1 )	0.0	Hz	O	O	O	O	O	O	
11-10	Jump frequency 3	0.0~400.0 0.0~1200.0 (when 00-31 = 1 )	0.0	Hz	O	O	O	O	O	O	
11-11	Jump frequency width	0.0~25.5	1.0	Hz	O	O	O	O	O	O	
11-12	Manual energy saving gain	0~100	80	%	O	O	X	X	X	X	
11-13	Retain										
11-14	Retain										
11-15	Retain										
11-16	Retain										
11-17	Retain										
11-18	Manual energy saving frequency	0.00~400.00 0.0~1200.0 (when 00-31 = 1 )	0.00	Hz	O	X	X	X	X	X	
11-19	Automatic energy saving function	0: Automatic energy saving is invalid	0	-	O	X	X	X	X	X	
		1: Automatic energy saving is valid									
11-20	Filter time of automatic energy saving	0~200	140	ms	O	X	X	X	X	X	
11-21	Voltage upper limit of energy saving tuning	0~100	100	%	O	X	X	X	X	X	

Group 11 Auxiliary Function Group												
Code	Parameter Name	Range	Default	Unit	Control mode						Attribute	
					V/F	V/F +PG	SLV	SV	PM SV	PM SLV		
11-22	Adjustment time of automatic energy saving	0~5000	20	ms	O	X	X	X	X	X	*1	
11-23	Detection level of automatic energy saving	0~100	10	%	O	X	X	X	X	X		
11-24	Coefficient of automatic energy saving	0.00~655.35	-	-	O	X	X	X	X	X		
11-25	Retain											
11-26	Retain											
11-27	Retain											
11-28	Retain											
11-29	Auto De-rating Selection	0: invalid	0	-	O	X	X	X	X	X		
		1: valid										
11-30	Variable Carrier Frequency Max. Limit	2~16	-	KHz	O	O	X	X	X	X		
11-31	Variable Carrier Frequency Min. Limit	2~16	-	KHz	O	O	X	X	X	X		
11-32	Variable Carrier Frequency Proportional Gain	00~99	00	-	O	O	X	X	X	X		
11-33	DC Voltage Filter Rise Amount	0.1~10.0	0.1	Vdc	O	O	X	X	X	X	*1	
11-34	DC Voltage Filter Fall Amount	0.1~10.0	5.0	Vdc	O	O	X	X	X	X	*1	
11-35	DC Voltage Filter Deadband Level	0.0~99.0	10.0	Vdc	O	O	X	X	X	X	*1	
11-36	Frequency gain of OV prevention	0.000~1.000	0.050	-	O	O	X	X	X	X	*1	
11-37	Frequency limit of OV prevention	0.00~10.00	5.00	Hz	O	O	X	X	X	X		
11-38	Deceleration start voltage of OV prevention	200V: 200~400V	300	V	O	O	X	X	X	X		
		400V: 400~800V	700									
11-39	Deceleration stop voltage of OV prevention	220V: 300~400V	350	V	O	O	X	X	X	X		
		440V: 600~800V	750									
11-40	OV prevention Selection	0: invalid	0	-	O	O	X	X	X	X		
		1: valid										

Code	Parameter Name	Range	Default	Unit	Control mode						Attribute
					V/F	V/F +PG	SLV	SV	PM SV	PM SLV	
11-41	Selection of detecting the disappearance of reference frequency	0: When referring to frequency disappears, the deceleration stops	0	-	O	O	O	O	O	O	
		1: When referring to frequency disappears, operation will be based on the proportion of reference frequency x 11-42									
11-42	Disappearance level of reference frequency	0.0~100.0	80.0	%	O	O	O	O	O	O	
11-43	Hold Frequency at Start	0.0~400.0	0.0	Hz	O	O	O	O	O	O	
11-44	Frequency hold Time at Start	0.0~10.0	0.0	s	O	O	O	O	O	O	
11-45	Hold Frequency at Stop	0.0~400.0	0.0	Hz	O	O	O	O	O	O	
11-46	Frequency hold Time at Stop	0.0~10.0	0.0	s	O	O	O	O	O	O	
11-47	KEB deceleration time	0.0~25.5	0.0	s	O	O	O	O	O	O	*1
11-48	KEB detection Level	200V: 190~210	200	V	O	O	O	O	O	O	
		400V: 380~420	400								
11-49	Zero-servo gain	0~50	5	-	X	X	O	O	O	O	
11-50	Zero-servo Count	0~4096	12	-	X	X	O	O	O	O	
11-51	Braking selection of zero speed	0: invalid	0	-	O	X	X	X	X	X	
		1: valid									
11-52	Droop control level	0.0~100.0%	0.0	%	X	X	X	O	O	X	*1
11-53	Droop control delay	0.01~2.00	0.02	s	X	X	X	O	O	X	*1
11-54	Output KWHR initialization	0: don't clear output KWHR	0	-	O	O	O	O	O	O	*1
		1: clear output KWHR									
11-55	STOP key selection	0: Stop key is invalid when the operation command is not provided by operator.	1	-	O	O	O	O	O	O	
		1: Stop key is valid when the operation command is not provided by operator.									
11-56	UP/DOWN selection	0: when operator's UP/DOWN is invalid, it will be valid if press ENTER after frequency modification.	0	-	O	O	O	O	O	O	
		1: when operator's UP/DOWN is valid, it will be valid after frequency modification.									
11-57	Retain										
11-58	Record reference frequency	0: invalid	0	-	O	O	O	O	O	O	*1
		1: valid									

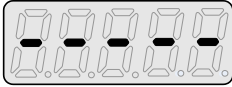
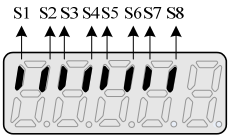
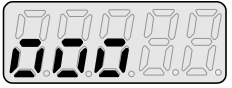
Group 12 Monitoring Function Group											
Code	Parameter Name	Range	Default	Unit	Control mode						Attribute
					V/F	V/F+PG	SLV	SV	PM SV	PM SLV	
12-00	Display screen selection (LED)	00000~77777 From the leftmost bit, it displays the screen when press DSP key in order. 0:no display 1: Output current 2: Output voltage 3:DC bus voltage 4:heatsink temperature 5:PID feedback 6:AI1 value 7:AI2 value	00000	-							
12-01	PID feedback display mode (LED)	0:Display the feedback value by integer (xxx)	0								
		1: Display the feedback value by the value with one decimal place (xx.x)									
		2: Display the feedback value by the value with two decimal places (x.xx)									
12-02	PID feedback display unit setting (LED)	0:xxxxx (no unit)	0								
		1:xxxPb(pressure)									
		2:xxxFL(flow)									
12-03	Retain										
12-04	Retain										
12-05	Status display of digital input terminal (LED / LCD)	LED display is shown as below no input  correspondences to input and output S1 S2 S3 S4 S5 S6 S7 S8   R1 R2 DOI LCM display is shown as below	-	-							

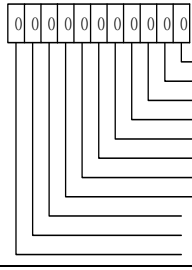

**Group 12 Monitoring Function Group**

Code	Parameter Name	Range	Default	Unit	Control mode						Attribute
					V/F	V/F +PG	SLV	SV	PM SV	PM SLV	
		 <p>0 : OPEN 1 : CLOSE</p> <p>Input Terminal(S8) Input Terminal(S7) Input Terminal(S6) Input Terminal(S5) Input Terminal(S4) Input Terminal(S3) Input Terminal(S2) Input Terminal(S1) Output Terminal(DO1) Output Terminal(R2) Output Terminal(R1)</p>									
12-06	Retain										
12-07	Retain										
12-08	Retain										
12-09	Retain										
12-10	Retain										
12-11	Output current of current fault	Display the output current of current fault	-	A	0	0	0	0	0	0	
12-12	Output voltage of current fault	Display the output voltage of current fault	-	V	0	0	0	0	0	0	
12-13	Output frequency of current fault	Display the output frequency of current fault	-	Hz	0	0	0	0	0	0	
12-14	DC voltage of current fault	Display the DC voltage of current fault	-	V	0	0	0	0	0	0	
12-15	Frequency command of current fault	Display the frequency command of current fault	-	Hz	0	0	0	0	0	0	
12-16	Frequency command	If LED enters this parameter, it only allows monitoring frequency command.	-	Hz	0	0	0	0	0	0	
12-17	Output frequency	Display the current output frequency	-	Hz	0	0	0	0	0	0	
12-18	Output current	Display the current output current	-	A	0	0	0	0	0	0	
12-19	Output voltage	Display the current output voltage	-	V	0	0	0	0	0	0	
12-20	DC voltage (Vdc)	Display the current DC voltage	-	V	0	0	0	0	0	0	
12-21	Output power(kw)	Display the current output power	-	kW	0	0	0	0	0	0	
12-22	Motor's rotation speed (rpm)	Display motor's current rotation speed in VF/SLV mode Motor's rotation speed = output power x(120/motor's pole number) In PG/SV mode, motor's rotation speed is calculated by feedback frequency.	-	rpm	0	0	0	0	0	0	
12-23	Output power factor (Pfo)	Display the current output power factor	-	-	0	0	0	0	0	0	
12-24	Control mode	Display control mode 0 : VF      1 : PG 2 : SLV     3 : SV	-	-	0	0	0	0	0	0	

Group 12 Monitoring Function Group												
Code	Parameter Name	Range	Default	Unit	Control mode						Attribute	
					V/F	V/F +PG	SLV	SV	PM SV	PM SLV		
		4 : PSV										
12-25	AI1 input	Display the current AI1 input (-10V corresponds to -100%, 10V corresponds to 100%,)	-	%	O	O	O	O	O	O		
12-26	AI2 input	Display the current AI2 input (0V or 4mA corresponds to 0%, 10V or 20mA corresponds to 100%)	-	%	O	O	O	O	O	O		
12-27	Torque command	Display the current torque command (100% corresponds to motor torque)	-	%	X	X	O	O	O	O		
12-28	Motor torque current (Iq)	Display the current q-axis current	-	%	X	X	O	O	O	O		
12-29	Motor excitation current (Id)	Display the current d-axis current	-	%	X	X	O	O	O	O		
12-30	ASR deviation	Display deviation of speed controller (speed command - speed feedback) (100% corresponds to the maximum frequency set by 01-02)	-	%	X	O	X	O	O	X		
12-31	ASR filter output	Display output of speed controller (100% corresponds to the maximum frequency set by 01-02)	-	%	X	O	X	O	O	X		
12-32	ASR output	Display output value of speed controller (100% corresponds to the maximum frequency set by 01-02)	-	%	X	O	X	O	O	X		
12-33	PG feedback	Display feedback's speed value of speed controller (100% corresponds to the maximum frequency set by 01-02)	-	%	X	O	X	O	O	X		
12-34	Retain											
12-35	Zero-servo pulse	When display SV position mode, the position error pulse number of the zero speed servo (the pulse number of a circle is four times of set values of 20-27)	-	Pulse	X	X	X	O	O	X		
12-36	PID input	Display input error of the PID controller (PID target value - PID feedback) (100% corresponds to the	0.01	%	O	O	O	O	O	O		

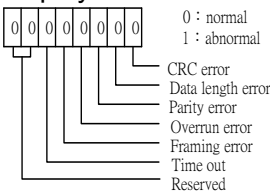
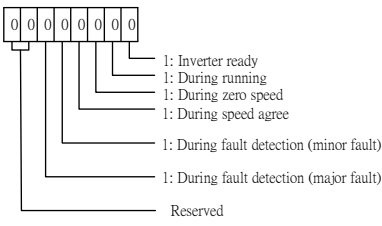
Group 12 Monitoring Function Group											
Code	Parameter Name	Range	Default	Unit	Control mode						Attribute
					V/F	V/F +PG	SLV	SV	PM SV	PM SLV	
		maximum frequency set by 01-02 or 01-16)									
12-37	PID output	Display output of the PID controller (100% corresponds to the maximum frequency set by 01-02 or 01-16)	-	%	0	0	0	0	0	0	
12-38	PID setting	Display the target value of the PID controller (100% corresponds to the maximum frequency set by 01-02 or 01-16)	-	%	0	0	0	0	0	0	
12-39	PID feedback	Display the feedback value of the PID controller (100% corresponds to the maximum frequency set by 01-02 or 01-16)	-	%	0	0	0	0	0	0	
12-40	Motor's cumulative output energy	Display motor's cumulative output energy	-	KW Hr	0	0	0	0	0	0	
12-41	Heatsink temperature	Display the heatsink temperature of IGBT temperature.	-	Degree C	0	0	0	0	0	0	
12-42	RS-485 error code	Display the status of RS-485 	-	-	0	0	0	0	0	0	
12-43	Inverter status		-	-	0	0	0	0	0	0	
12-44	Pulse input frequency	Display the frequency value of pulse input	-	Hz	0	0	0	0	0	0	
12-45	Recent fault message	Display current fault message	-	-	0	0	0	0	0	0	
12-46	Previous fault message	Display previous fault message	-	-	0	0	0	0	0	0	
12-47	Previous two fault messages	Display previous two fault messages	-	-	0	0	0	0	0	0	
12-48	Previous three fault messages	Display previous three fault messages	-	-	0	0	0	0	0	0	
12-49	Previous four fault messages	Display previous four fault messages	-	-	0	0	0	0	0	0	
12-50	DIO status of current fault	Display the DI/DO status of current fault	-	-	0	0	0	0	0	0	

Group 12 Monitoring Function Group											
Code	Parameter Name	Range	Default	Unit	Control mode						Attribute
					V/F	V/F +PG	SLV	SV	PM SV	PM SLV	
		Description is similar to 12-05									
12-51	Inverter status of current fault	Display the inverter status of current fault Description is similar to 12-43	-	-	O	O	O	O	O	O	
12-52	Trip time 1 of current fault	Display the operation time of current fault,12-53 is the days,	-	Hr	O	O	O	O	O	O	
12-53	Trip time 2 of current fault	while 12-52 is the ahemeral hours .	-	day	O	O	O	O	O	O	
12-54	Frequency command of previous fault	Display frequency command of previous fault	-	Hz	O	O	O	O	O	O	
12-55	Output frequency of previous fault	Display output frequency of previous fault	-	Hz	O	O	O	O	O	O	
12-56	Output current of previous fault	Display output current of previous fault	-	A	O	O	O	O	O	O	
12-57	Output voltage of previous fault	Display output voltage of previous fault	-	V	O	O	O	O	O	O	
12-58	DC voltage of previous fault	Display DC voltage of previous fault	-	V	O	O	O	O	O	O	
12-59	DIO status of previous fault	Display DI/DO status of previous fault Description is similar to 12-05	-	-	O	O	O	O	O	O	
12-60	Inverter status of previous fault	Display inverter status of previous fault Description is similar to 12-43	-	-	O	O	O	O	O	O	
12-61	Trip time 1 of last fault	Display the operation time of last time's fault,12-62 is the days,	-	Hr	O	O	O	O	O	O	
12-62	Trip time 2 of last fault	while 12-61 is the ahemeral hours .	-	day	O	O	O	O	O	O	
12-63	Recent warning messages	Display the recent warning messages	-	-	O	O	O	O	O	O	
12-64	Previous warning message	Display the previous warning message	-	-	O	O	O	O	O	O	

Group 13 Maintenance Function Group											
Code	Parameter Name	Range	Default	Unit	Control mode						Attribute
					V/F	V/F +PG	SLV	SV	PM SV	PM SLV	
13-00	Inverter Capacity Selection	----	-	-	0	0	0	0	0	0	*4
13-01	Software Version	----	-	-	0	0	0	0	0	0	*4
13-02	Retain										
13-03	Cumulative operation hours 1	0~23	-	hr	0	0	0	0	0	0	*4
13-04	Cumulative operation hours 2	0~65535	-	day	0	0	0	0	0	0	*4
13-05	Selection of cumulative operation time	0: Cumulative time in power on 1: Cumulative time in operation	0	-	0	0	0	0	0	0	*1
13-06	Parameters locked	0: Parameters out of 13-06 are unwritable. 1: Retain 2: all parameters are writable	2	-	0	0	0	0	0	0	*1
13-07	Parameter password function	0~9999	0	-	0	0	0	0	0	0	
13-08	Restore factory setting	0: no initialization 2: 2 wire initialization(230/460V) 3: 3 wire initialization(230/460V) 4: 2 wire initialization(200/415V) 5: 3 wire initialization(200/415V) 6: 2 wire initialization(200/380V) 7: 2 wire initialization(200/380V) Others: Retain	0	-	0	0	0	0	0	0	
13-09	Fault history clearance function	0: no clearing fault history 1: Clear fault history	0	-	0	0	0	0	0	0	*1

**Group 14 PLC Setting Group**

Code	Parameter Name	Range	Default	Unit	Control mode						Attribute
					V/F	V/F +PG	SLV	SV	PM SV	PM SLV	
14-00	T1 set value 1	0~9999	0	-	0	0	0	0	0	0	
14-01	T1 set value 2 (mode 7)	0~9999	0	-	0	0	0	0	0	0	
14-02	T2 set value 1	0~9999	0	-	0	0	0	0	0	0	
14-03	T2 set value 2 ( mode 7)	0~9999	0	-	0	0	0	0	0	0	
14-04	T3 set value 1	0~9999	0	-	0	0	0	0	0	0	
14-05	T3 set value 2 (mode 7)	0~9999	0	-	0	0	0	0	0	0	
14-06	T4 set value 1	0~9999	0	-	0	0	0	0	0	0	
14-07	T4 set value 2 (mode 7)	0~9999	0	-	0	0	0	0	0	0	
14-08	T5 set value 1	0~9999	0	-	0	0	0	0	0	0	
14-09	T5 set value 2 (mode 7)	0~9999	0	-	0	0	0	0	0	0	
14-10	T6 set value 1	0~9999	0	-	0	0	0	0	0	0	
14-11	T6 set value 2 (mode 7)	0~9999	0	-	0	0	0	0	0	0	
14-12	T7 set value 1	0~9999	0	-	0	0	0	0	0	0	
14-13	T7 set value 2 (mode 7)	0~9999	0	-	0	0	0	0	0	0	
14-14	T8 set value 1	0~9999	0	-	0	0	0	0	0	0	
14-15	T8 set value 2 (mode 7)	0~9999	0	-	0	0	0	0	0	0	
14-16	C1 set value	0~65535	0	-	0	0	0	0	0	0	
14-17	C2 set value	0~65535	0	-	0	0	0	0	0	0	
14-18	C3 set value	0~65535	0	-	0	0	0	0	0	0	
14-19	C4 set value	0~65535	0	-	0	0	0	0	0	0	
14-20	C5 set value	0~65535	0	-	0	0	0	0	0	0	
14-21	C6 set value	0~65535	0	-	0	0	0	0	0	0	
14-22	C7 set value	0~65535	0	-	0	0	0	0	0	0	
14-23	C8 set value	0~65535	0	-	0	0	0	0	0	0	
14-24	AS1 set value 1	0~65535	0	-	0	0	0	0	0	0	
14-25	AS1 set value 2	0~65535	0	-	0	0	0	0	0	0	
14-26	AS1 set value 3	0~65535	0	-	0	0	0	0	0	0	
14-27	AS2 set value 1	0~65535	0	-	0	0	0	0	0	0	
14-28	AS2 set value 2	0~65535	0	-	0	0	0	0	0	0	
14-29	AS2 set value 3	0~65535	0	-	0	0	0	0	0	0	
14-30	AS3 set value 1	0~65535	0	-	0	0	0	0	0	0	
14-31	AS3 set value 2	0~65535	0	-	0	0	0	0	0	0	
14-32	AS3 set value 3	0~65535	0	-	0	0	0	0	0	0	
14-33	AS4 set value 1	0~65535	0	-	0	0	0	0	0	0	
14-34	AS4 set value 2	0~65535	0	-	0	0	0	0	0	0	
14-35	AS4 set value 3	0~65535	0	-	0	0	0	0	0	0	
14-36	MD1 set value 1	0~65535	1	-	0	0	0	0	0	0	
14-37	MD1 set value 2	0~65535	1	-	0	0	0	0	0	0	
14-38	MD1 set value 3	0~65535	1	-	0	0	0	0	0	0	
14-39	MD2 set value 1	0~65535	1	-	0	0	0	0	0	0	
14-40	MD2 set value 2	0~65535	1	-	0	0	0	0	0	0	
14-41	MD2 set value 3	0~65535	1	-	0	0	0	0	0	0	
14-42	MD3 set value 1	0~65535	1	-	0	0	0	0	0	0	
14-43	MD3 set value 2	0~65535	1	-	0	0	0	0	0	0	
14-44	MD3 set value 3	0~65535	1	-	0	0	0	0	0	0	
14-45	MD4 set value 1	0~65535	1	-	0	0	0	0	0	0	

Group 14 PLC Setting Group											
Code	Parameter Name	Range	Default	Unit	Control mode						Attribute
					V/F	V/F +PG	SLV	SV	PM SV	PM SLV	
14-46	MD4 set value 2	0~65535	1	-	0	0	0	0	0	0	
14-47	MD4 set value 3	0~65535	1	-	0	0	0	0	0	0	

Group 15 PLC Monitoring Group											
Code	Parameter Name	Range	Default	Unit	Control mode						Attribute
					V/F	V/F +PG	SLV	SV	PM SV	PM SLV	
15-00	T1 current value1	0~9999	0	-	0	0	0	0	0	0	
15-01	T1 current value2 (mode7)	0~9999	0	-	0	0	0	0	0	0	
15-02	T2 current value1	0~9999	0	-	0	0	0	0	0	0	
15-03	T2 current value2 (mode7)	0~9999	0	-	0	0	0	0	0	0	
15-04	T3 current value1	0~9999	0	-	0	0	0	0	0	0	
15-05	T3 current value2 (mode7)	0~9999	0	-	0	0	0	0	0	0	
15-06	T4 current value1	0~9999	0	-	0	0	0	0	0	0	
15-07	T4 current value2 (mode7)	0~9999	0	-	0	0	0	0	0	0	
15-08	T5 current value1	0~9999	0	-	0	0	0	0	0	0	
15-09	T5 current value2 (mode7)	0~9999	0	-	0	0	0	0	0	0	
15-10	T6 current value1	0~9999	0	-	0	0	0	0	0	0	
15-11	T6 current value2 (mode7)	0~9999	0	-	0	0	0	0	0	0	
15-12	T7 current value1	0~9999	0	-	0	0	0	0	0	0	
15-13	T7 current value2 (mode7)	0~9999	0	-	0	0	0	0	0	0	
15-14	T8 current value1	0~9999	0	-	0	0	0	0	0	0	
15-15	T8 current value2 (mode7)	0~9999	0	-	0	0	0	0	0	0	
15-16	C1 current value	0~65535	0	-	0	0	0	0	0	0	
15-17	C2 current value	0~65535	0	-	0	0	0	0	0	0	
15-18	C3 current value	0~65535	0	-	0	0	0	0	0	0	
15-19	C4 current value	0~65535	0	-	0	0	0	0	0	0	
15-20	C5 current value	0~65535	0	-	0	0	0	0	0	0	
15-21	C6 current value	0~65535	0	-	0	0	0	0	0	0	
15-22	C7 current value	0~65535	0	-	0	0	0	0	0	0	
15-23	C8 current value	0~65535	0	-	0	0	0	0	0	0	
15-24	AS1 current value	0~65535	0	-	0	0	0	0	0	0	
15-25	AS2 current value	0~65535	0	-	0	0	0	0	0	0	
15-26	AS3 current value	0~65535	0	-	0	0	0	0	0	0	
15-27	AS4 current value	0~65535	0	-	0	0	0	0	0	0	
15-28	MD1 current value	0~65535	0	-	0	0	0	0	0	0	
15-29	MD2 current value	0~65535	0	-	0	0	0	0	0	0	

Group 15 PLC Monitoring Group											
Code	Parameter Name	Range	Default	Unit	Control mode						Attribute
					V/F	V/F +PG	SLV	SV	PM SV	PM SLV	
15-30	MD3 current value	0~65535	0	-	0	0	0	0	0	0	
15-31	MD4 current value	0~65535	0	-	0	0	0	0	0	0	
15-32	TD current value	0~65535	0	-	0	0	0	0	0	0	

Group 16 LCM Function Group											
Code	Parameter Name	Range	Default	Unit	Control mode						Attribute
					V/F	V/F +PG	SLV	SV	PM SV	PM SLV	
16-00	Main screen monitoring	5~64 when using LCM to operate, the monitored item displays in the first line. (default is frequency command)	16	-	0	0	0	0	0	0	*1
16-01	Sub-screen monitoring 1	5~64 when using LCM to operate, the monitored item displays in the second line. (default is output frequency)	17	-	0	0	0	0	0	0	*1
16-02	Sub-screen monitoring 2	5~64 when using LCM to operate, the monitored item displays in the third line. (default is output current)	18	-	0	0	0	0	0	0	*1
16-03	Display unit	0~39999 determine the display way and unit of frequency command 0: Frequency display unit is 0.01Hz 1: Frequency display unit 0.01% 2~38: rpm, the set number represents the pole number of motor 40~9999: Users specify the format, Inputing 0XXXX represents the display of XXXX at 100%. 10001~19999: Users specify the format, Inputing 1XXXX represents the display of XXX.X at 100%. 20001~29999: Users specify the format, Inputing 1XXXX represents the display of XX.XX at 100%. 30001~39999:	0	-	0	0	0	0	0	0	



**Group 16 LCM Function Group**

Code	Parameter Name	Range	Default	Unit	Control mode						Attribute
					V/F	V/F +PG	SLV	SV	PM SV	PM SLV	
		Users specify the format, Inputing 1XXXX represents the display of X.XXX at 100%.									
16-04	Engineering unit	0: without using engineering unit	0	-	0	0	0	0	0	0	X
		1: FPM									
		2: CFM									
		3: PSI									
		4: GPH									
		5: GPM									
		6: IN									
		7: FT									
		8: /s									
		9: /m									
		10: /h									
		11: °F									
		12: inW									
		13: HP									
		14: m/s									
		15: MPM									
		16: CMM									
		17: W									
		18: KW									
		19: m									
		20: °C									
16-05	LCD backlight	0~7	5	-	0	0	0	0	0	0	*1
16-06	Automatic return time	0~120	60	Sec	0	0	0	0	0	0	*1
16-07	Copy selection function	0: Do not copy parameters	0	-	0	0	0	0	0	0	
		1: Read inverter parameters and save to the operator.									
		2: Write the operator parameters to inverter.									
		3: Compare parameters of inverter and operator.									
16-08	Selection of allowing reading	0: Do not allow to read inverter parameters and save to the operator.	0	-	0	0	0	0	0	0	
		1: Allow to read inverter parameters parameters and save to the operator.									
16-09	Selection of operator breaking off (LCD)	0: Display fault when LCD operator is broken off.	0	-	0	0	0	0	0	0	*1
		1: Keep operating when LCD operator is broken off.									

**Group 17 Automatic Tuning Function Group**

Code	Parameter Name	Range	Default	Unit	Control mode						Attribute
					V/F	V/F+PG	SLV	SV	PM SV	PM SLV	
17-00	Mode selection of automatic tuning	0: rotation autotune	0	-	O	O	O	O	X	X	
		1: static autotune									
		2: stator resistance measurement									
17-01	Motor rated output power	0.00~600.00	-	KW	O	O	O	O	X	X	
17-02	Motor rated current	0.1~999.9	-	A	O	O	O	O	X	X	
17-03	Motor rated voltage	200V: 0.0~255.0	220	V	O	O	O	O	X	X	
		400V:0.0~510.0	440								
17-04	Motor rated frequency	10.0~400.0 10.0~1200.0 (when 00-31 = 1)	60.0	Hz	O	O	O	O	X	X	
17-05	Motor rated speed	0~24000	1750	rpm	O	O	O	O	X	X	
17-06	Pole number of motor	2,4,6,8	4	Pole	O	O	O	O	X	X	
17-07	Number of PG pulse	0~60000	1024	ppr	X	O	X	O	X	X	
17-08	Motor no-load voltage	200V: 50~240	-	V	O	O	O	O	X	X	
		400V:100~480									
17-09	motor excitation current	0.01~600.00	-	A	O	O	O	O	X	X	
17-10	Automatic tuning start	0: invalid	0	-	O	O	O	O	X	X	
		1: valid									
17-11	Error history of automatic tuning	0: No error	0	-	O	O	O	O	X	X	
		1: Motor data error									
		2: stator resistance tuning error									
		3:leakage induction tuning error									
		4: Rotor resistance tuning error									
		5: mutual induction tuning error									
		6: encoder error									
		7: DT Error									
		8: Motor's acceleration error									
9: Warning											

Group 18 Slip Compensation Group											
Code	Parameter Name	Range	Default	Unit	Control mode						Attribute
					V/F	V/F +PG	SLV	SV	PM SV	PM SLV	
18-00	Slip compensation gain at low speed.	0.00~2.50	-	-	O	X	O	O	X	X	*1
18-01	Slip compensation gain at high speed.	-1.00~1.00	0.0	-	O	X	O	X	X	X	*1
18-02	Slip compensation limit	0~250	200	%	O	X	O	X	X	X	
18-03	Slip compensation filter	0.0~10.0	1.0	Sec	O	X	X	X	X	X	
18-04	Regenerative slip compensation selection	0: invalid	0	-	O	X	X	X	X	X	
		1: valid									
18-05	FOC delay time	1~1000	100	ms	X	X	O	X	X	X	
18-06	FOC gain	0.00~2.00	0.1	-	X	X	O	X	X	X	

Group 19 Wobble Frequency Function Group											
Code	Parameter Name	Range	Default	Unit	Control mode						Attribute
					V/F	V/F +PG	SLV	SV	PM SV	PM SLV	
19-00	Center frequency of wobble frequency	5.00~100.00	20.00	%	O	O	X	X	X	X	*1
19-01	Amplitude of wobble frequency	0.1~20.0	10.0	%	O	O	X	X	X	X	*1
19-02	Jump frequency of wobble frequency	0.0~50.0	0.0	%	O	O	X	X	X	X	*1
19-03	Jump time of wobble frequency	0~50	0	ms	O	O	X	X	X	X	*1
19-04	wobble frequency cycle	0.0~1000.0	10.0	Sec	O	O	X	X	X	X	*1
19-05	wobble frequency ratio	0.1~10.0	1.0		O	O	X	X	X	X	*1
19-06	Upper offset amplitude of wobble frequency	0.0~20.0	0.0	%	O	O	X	X	X	X	*1
19-07	Lower offset amplitude of wobble frequency	0.0~20.0	0.0	%	O	O	X	X	X	X	*1

Group 20 Speed Control Function Group											
Code	Parameter Name	Range	Default	Unit	Control mode						Attribute
					V/F	V/F +PG	SLV	SV	PM SV	PM SLV	
20-00	ASR gain 1	0.00~250.00	-	-	X	O	O	O	O	O	*1
20-01	ASR integral time 1	0.001~10.000	-	Sec	X	O	O	O	O	O	*1
20-02	ASR gain 2	0.00~250.00	-	-	X	O	O	O	O	X	*1
20-03	ASR integral time 2	0.001~10.000	-	Sec	X	O	O	O	O	X	*1
20-04	ASR integral time limit	0~300	200	%	X	X	O	O	O	O	
20-05	ASR positive limit	0.1 ~ 10.0	5.0	%	X	O	X	X	X	X	
20-06	ASR negative limit	0.1 ~ 10.0	1.0	%	X	O	X	X	X	X	
20-07	Selection of acceleration and deceleration of P/PI	0: PI speed control will be valid only in constant speed. For the speed acceleration and deceleration, only use P control.	0	-	X	O	O	O	O	O	
		1: Speed control is valid either in acceleration or deceleration.									
20-08	ASR delay time	0.000~0.500	0.001	Sec	X	X	O	O	O	O	
20-09	Speed Observer Proportional(P) Gain1	0.00~2.55	0.61	-	X	X	O	X	X	O	*1
20-10	Speed Observer Integral(I) Time 1	0.01~10.00	0.05	Sec	X	X	O	X	X	O	*1
20-11	Speed Observer Proportional(P) Gain2	0.00~2.55	0.61	-	X	X	O	X	X	O	*1
20-12	Speed Observer Integral(I) Time 2	0.01~10.00	0.06	Sec	X	X	O	X	X	O	*1
20-13	Low-pass Filter Time constant of speed feedback 1	1~1000	4	ms	X	X	O	X	X	O	
20-14	Low-pass Filter Time constant of speed feedback 2	1~1000	30	ms	X	X	O	X	X	O	
20-15	ASR gain change frequency 1	0.0~400.0	4.0	Hz	X	O	O	X	X	O	
20-16	ASR gain change frequency 2	0.0~400.0	8.0	Hz	X	X	O	X	X	O	
20-17	Torque compensation gain at low speed	0.00~2.50	1.00	-	X	X	O	X	X	O	*1
20-18	Torque compensation gain at high speed	-10~10	0	%	X	X	O	X	X	O	*1
20-19	Over speed (OS) selection	0: Deceleration to stop	1		X	O	X	O	O	X	
		1: Coast to stop									
		2: Continue to operate									
20-20	Over speed (OS) detection level	0~120	115	%	X	O	X	O	O	X	
20-21	Over speed (OS) detection time	0.0~2.0	0.5	Sec	X	O	X	O	O	X	
20-22	Speed deviation (DEV) selection	0: Deceleration to stop	2		X	O	X	O	O	X	
		1: Coast to stop									

Group 20 Speed Control Function Group											
Code	Parameter Name	Range	Default	Unit	Control mode						Attribute
					V/F	V/F +PG	SLV	SV	PM SV	PM SLV	
		2: Continue to operate									
20-23	Speed deviation (DEV) detection level	0~50	10	%	X	O	X	O	O	X	
20-24	Speed deviation (DEV) detection time	0.0~10.0	0.5	Sec	X	O	X	O	O	X	
20-25	Selection of PG Open	0: Deceleration to stop	1	-	X	O	X	O	O	X	
		1: Coast to stop									
		2: Continue to operate									
20-26	Detection time of PG Open	0.0~10.0	2.0	Sec	X	O	X	O	O	X	
20-27	PG pulse number	0~60000	1024	ppr	X	O	X	O	O	X	
20-28	Selection of PG rotation direction	0: Forward as counter-clockwise rotation	0	-	X	O	X	O	O	X	
		1: Forward as clockwise rotation									
20-29	PG pulse dividing ratio	001~132 if parameter is set to XYZ, PG card's dividing ratio will be (X+1)/YZ	1	-	X	O	X	O	O	X	
20-30	PG gear ratio 1	1~1000	1	-	X	O	X	X	X	X	
20-31	PG gear ratio 2	1~1000	1	-	X	O	X	X	X	X	

Group 21 Torque And Position Control Function Group											
Code	Parameter Name	Range	Default	Unit	Control mode						Attribute
					V/F	V/F +PG	SLV	SV	PM SV	PM SLV	
21-00	Torque control selection	0: Speed control	0	-	X	X	X	O	O	X	
		1: Torque control									
21-01	Filter time of torque reference	0~1000	0	ms	X	X	X	O	O	X	
21-02	Speed limit selection	0: according to AI input	0	-	X	X	X	O	O	X	
		1: according to the set value of 21-03									
21-03	Speed limit value	-120~120	0	%	X	X	X	O	O	X	
21-04	Bias voltage of speed limit	0~120	0	%	X	X	X	O	O	X	
21-05	Positive torque limit	0~300	-	%	X	X	O	O	O	O	
21-06	Negative torque limit	0~300	-	%	X	X	O	O	O	O	
21-07	Forward regenerative torque limit	0~300	-	%	X	X	O	O	O	O	
21-08	Reversal regenerative torque limit	0~300	-	%	X	X	O	O	O	O	
21-09	Maximum frequency of position control	0.1~100.0	20.0	Hz	X	X	X	O	O	X	
21-10	The command of	-9999 ~ 9999	0	-	X	X	X	O	O	X	

**Group 21 Torque And Position Control Function Group**

Code	Parameter Name	Range	Default	Unit	Control mode						Attribute
					V/F	V/F +PG	SLV	SV	PM SV	PM SLV	
	rotation cycle number of section 0										
21-11	The command of the pulse number of section 0	-9999 ~ 9999	0	-	X	X	X	O	O	X	
21-12	The command of rotation cycle number of section 1	-9999 ~ 9999	0	-	X	X	X	O	O	X	
21-13	The command of the pulse number of section 1	-9999 ~ 9999	0	-	X	X	X	O	O	X	
21-14	The command of rotation cycle number of section 2	-9999 ~ 9999	0	-	X	X	X	O	O	X	
21-15	The command of the pulse number of section 2	-9999 ~ 9999	0	-	X	X	X	O	O	X	
21-16	The command of rotation cycle number of section 3	-9999 ~ 9999	0	-	X	X	X	O	O	X	
21-17	The command of the pulse number of section 3	-9999 ~ 9999	0	-	X	X	X	O	O	X	
21-18	The command of rotation cycle number of section 4	-9999 ~ 9999	0	-	X	X	X	O	O	X	
21-19	The command of the pulse number of section 4	-9999 ~ 9999	0	-	X	X	X	O	O	X	
21-20	The command of rotation cycle number of section 5	-9999 ~ 9999	0	-	X	X	X	O	O	X	
21-21	The command of the pulse number of section 5	-9999 ~ 9999	0	-	X	X	X	O	O	X	
21-22	The command of rotation cycle number of section 6	-9999 ~ 9999	0	-	X	X	X	O	O	X	
21-23	The command of the pulse number of section 6	-9999 ~ 9999	0	-	X	X	X	O	O	X	
21-24	The command of rotation cycle number of section 7	-9999 ~ 9999	0	-	X	X	X	O	O	X	
21-25	The command of the pulse number of section 7	-9999 ~ 9999	0	-	X	X	X	O	O	X	
21-26	The command of	-9999 ~ 9999	0	-	X	X	X	O	O	X	

**Group 21 Torque And Position Control Function Group**

Code	Parameter Name	Range	Default	Unit	Control mode						Attribute
					V/F	V/F +PG	SLV	SV	PM SV	PM SLV	
	rotation cycle number of section 8										
21-27	The command of the pulse number of section 8	-9999 ~ 9999	0	-	X	X	X	O	O	X	
21-28	The command of rotation cycle number of section 9	-9999 ~ 9999	0	-	X	X	X	O	O	X	
21-29	The command of the pulse number of section 9	-9999 ~ 9999	0	-	X	X	X	O	O	X	
21-30	The command of rotation cycle number of section 10	-9999 ~ 9999	0	-	X	X	X	O	O	X	
21-31	The command of the pulse number of section 10	-9999 ~ 9999	0	-	X	X	X	O	O	X	
21-32	The command of rotation cycle number of section 11	-9999 ~ 9999	0	-	X	X	X	O	O	X	
21-33	The command of the pulse number of section 11	-9999 ~ 9999	0	-	X	X	X	O	O	X	
21-34	The command of rotation cycle number of section 12	-9999 ~ 9999	0	-	X	X	X	O	O	X	
21-35	The command of the pulse number of section 12	-9999 ~ 9999	0	-	X	X	X	O	O	X	
21-36	The command of rotation cycle number of section 13	-9999 ~ 9999	0	-	X	X	X	O	O	X	
21-37	The command of the pulse number of section 13	-9999 ~ 9999	0	-	X	X	X	O	O	X	
21-38	The command of rotation cycle number of section 14	-9999 ~ 9999	0	-	X	X	X	O	O	X	
21-39	The command of the pulse number of section 14	-9999 ~ 9999	0	-	X	X	X	O	O	X	
21-40	The command of rotation cycle number of section 15	-9999 ~ 9999	0	-	X	X	X	O	O	X	
21-41	The command of the pulse number of section 15	-9999 ~ 9999	0	-	X	X	X	O	O	X	

Group 22 IPM Motor Parameter Group											
Code	Parameter Name	Range	Default	Unit	Control mode						Attribute
					V/F	V/F +PG	SLV	SV	PM SV	PM SLV	
22-00	PM motor rated power	0.00~600.00	-	kW	X	X	X	X	O	O	
22-01	PM motor rated voltage	200V: 50~240	220	V	X	X	X	X	O	O	
		400V: 100~480	440								
22-02	PM motor rated current	0.1~999.9	-	A	X	X	X	X	O	O	
22-03	PM motor 's pole number	2~96	6	poles	X	X	X	X	O	O	
22-04	PM motor's rotation speed	0~60000 (22-04, 22-06, only need to set one of them, the program will calculate the other.)	1500	rpm	X	X	X	X	O	O	
22-05	PM motor's maximum rotation speed	0~60000	2000	rpm	X	X	X	X	O	O	
22-06	PM motor frequency	0.0~400.0	75.0	Hz	X	X	X	X	O	O	
22-07	Retain										
22-08	Retain										
22-09	Retain										
22-10	Retain										
22-11	Retain										
22-12	Retain										
22-13	Retain										
22-14	Retain										
22-15	Retain										
22-16	Offset angle of the magnetic pole and PG origin	0~360	0	deg	X	X	X	X	O	X	*4
22-17	PM motor tuning	0: None	0	-	X	X	X	X	O	O	
		1: Magnetic pole alignment and loop adjustment									
		2: Magnetic pole alignment									
22-18	Fault history of PM motor tuning	0. No Error	0	--	X	X	X	X	O	O	*4
		1. static magnetic alignment fault									
		2. without PG option card									
		3. Rotation pole alignment is forced to stop									
		4. Rotation pole alignment is time-out.									
		5. Loop adjustment is time out									
		6. Encoder error									
		7. other errors of motor tuning									
		8. Current abnormality occurs when aligning rotation magnetic pole.									
		9. Current abnormality occurs while loop adjustment.									
10. Restart magnetic pole alignment and loop adjustment											



## 4.3 Description of Parameter Functions

### 00 Basic Function Group

00- 00	Control mode selection
Range	<b>【0】</b> : V/F <b>【1】</b> : V/F+PG <b>【2】</b> : SLV <b>【3】</b> : SV <b>【4】</b> : PMSV <b>【5】</b> : Retain

The control law of inverter has five modes, as shown in the following:

00-00 set value	Control law	Control base	Application range
0	V/F	. V / F mode without PG (open loop)	. Drive general motor . Replace the existing inverter . Applied in the occasion without requirement of auto-tuning . ND (Nomal duty) mode application
1	V/F+PG	. V / F mode with PG , with speed compensation . PG interface (option).	Simple closed-loop speed control. and its accuracy is higher than V / F mode.
2	SLV	. Current vector control without PG .( Sensorless Vector Control)	Applied in the occasion without requirement of PG attached, and it provides speed and torque requirements with high precision.
3	SV	. Current vector control with PG (Closed-loop current vector control). . PG interface (option).	. High-performance control with PG. . High-precision speed and torque control function.
4	PMSV	. For permanent magnet motor, current vector control with PG. (Closed-loop current vector control). . PG interface (option).	. High-performance control mode with PG for permanent magnet motor . High-precision speed and torque control function .

(1). 00-00=0

- . Select the required V/f curve (01-00) based on motor and application.
- . If the motor cable length is 50 meters or longer, you need to perform stationary auto-tuning (17-00 = 2). Please refer to Parameter 17 –description of auto-tuning function group to understand the related command of auto-tuning.

(2). 00-00=1

- . Select the required V/f curve (01-00) or the requirement of used motor and application
- . Select motor pole number (02-07) and pulse number of PG(pulse generator or encoder) (20-27)  
Refer to Parameter 20 – description of speed control function group to understand the related setting detail of PG feedback.
- . If the motor cable length is 50 meters or longer, you need to perform stationary auto-tuning (17-00 = 2)
- . Please refer to Parameter 17 –description of auto-tuning function group and motor parameter measurement to understand the related command of auto-tuning

(3). 00-00=2

- . Ensure the inverter capacity corresponds to the motor power. Use motor parameter tuning function to measure and store motor parameters.
- . Perform rotational auto-tuning to improve the performance of SLV mode.
- . Please refer to Parameter 17 –description of auto-tuning function group and motor parameter measurement to understand the related command of the auto-tuning.

(4). 00-00=3

- . Ensure the inverter capacity corresponds to the motor power. Use the auto-tuning function to measure and store motor parameters.
- . Please refer to Parameter 17 –description of auto-tuning function group and motor parameter measurement to understand the related command of the auto-tuning

(5) 00-00=4

- .Ensure the inverter capacity corresponds to the motor power. Please use the parameter setting from 22-00 to 22-06 to set related parameters of permanent magnet motor.
- . Select the pole number of permanent magnet motor (22-03) and pulse number of PG (pulse generator or encoder) (20-27).
- . Please refer to parameters 22-17 PM motor tuning function description.
- . Please choose braking resistance of appropriate power and resistance value based on motor power and application. For models of 220V 30HP (or 440V 40HP) or above, please install braking module.

This 00-00 parameter is not affected by the setting of initialization parameter.

<b>00- 01</b>	<b>Motor's rotation direction</b>
<b>Range</b>	<b>【0】 : Forward</b> <b>【1】 : Reverse</b>

If the operation command is controlled by keypad (00-02 set to "0), you can use the keypad to control the rotation direction, namely forward rotation or reverse rotation, the control result will be stored to 00-01. Users can directly modify 00-01 parameter to control rotation direction.

<b>00- 02</b>	<b>Run command selection</b>
<b>Range</b>	<b>【0】 : Keypad control</b> <b>【1】 : External terminal control</b> <b>【2】 :Communication control</b> <b>【3】 :PLC</b>

(1) 00-02=0:

Based on the setting of 00-02=0, use the keypad of digital operator (stop, operation and forward / reverse keys) to perform the operation of the inverter. Please refer to Section 4-1 use of panel.

(2) 00-02=1:

Based on the setting of 00-02=1, use the terminal of control circuit to perform the operation of the inverter.

■ **2-wire operation**

- . 2-wire operation is performed according to set 03-00 (S1 terminal function selection) to 0 (forward,operation/stop) and to set 03-01(S2 terminal function selection) to 1 (reversal,operation/stop) .
- . If S1 is ON and S2 is OFF, the inverter will operate forwardly; if S1 is OFF, the inverter will stop.
- . If S1 is OFF and S2 is on, the inverter will operate reversally; if S2 is OFF, the inverter will stop.
- . 2-wire control is shown as Figure 4.3.1, if S1 and S2 are turned on at the same time, 500 milliseconds later, warning of "EF9" (FWD-REV error) will be displayed and the inverter will stop. If the condition is cleared, the inverter resumes normal operation.

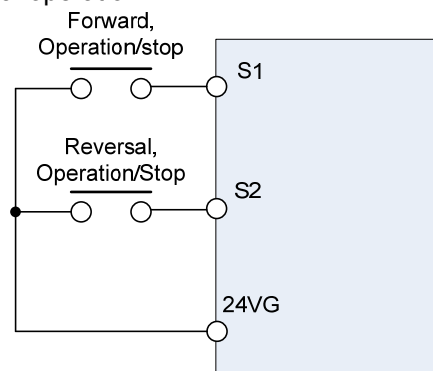

Figure 4.3.1 wiring example of 2-wire

- . When the inverter parameters 13-08 (Initialization) sets 2, 4 or 6 for 2-wire program initialization, multi-function input terminal S1 is forward , operation/ stop, and S2 is the command of reversal, operation / stop.

■ 3-wire operation

- . When any parameter(multi-function digital input terminals S3 ~ S8) from 03-02 to 03-07 is set to 26, and multi-function digital input terminals have been set to forward / reverse command, then S1 and S2 terminals will be set to operation command and stop command of 3-wire control. The original functions are turned off.
- . When the inverter parameters 13-08 (Initialization) sets 3, 5 or 7 for 3-wire program initialization, multi-function input terminal S7 is forward/reverse command.
- . 3-wire control is shown as Figure 4.3.2. Multi-function input terminal S7 is forward/reverse command.

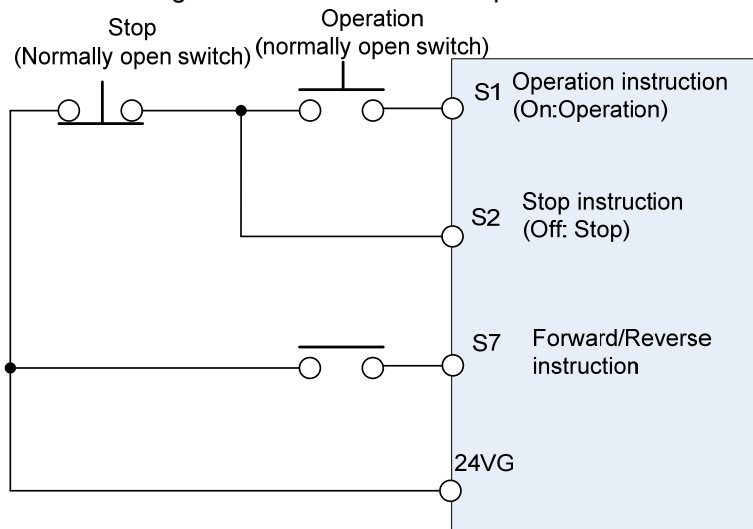

Figure 4.3.2 wiring example of 3-wire

- . Terminal S1 must be ON for 50 ms or longer time so that the operation command can perform self-sustaining. Refer to Figure 4.3.3 3-wire operation procedure.

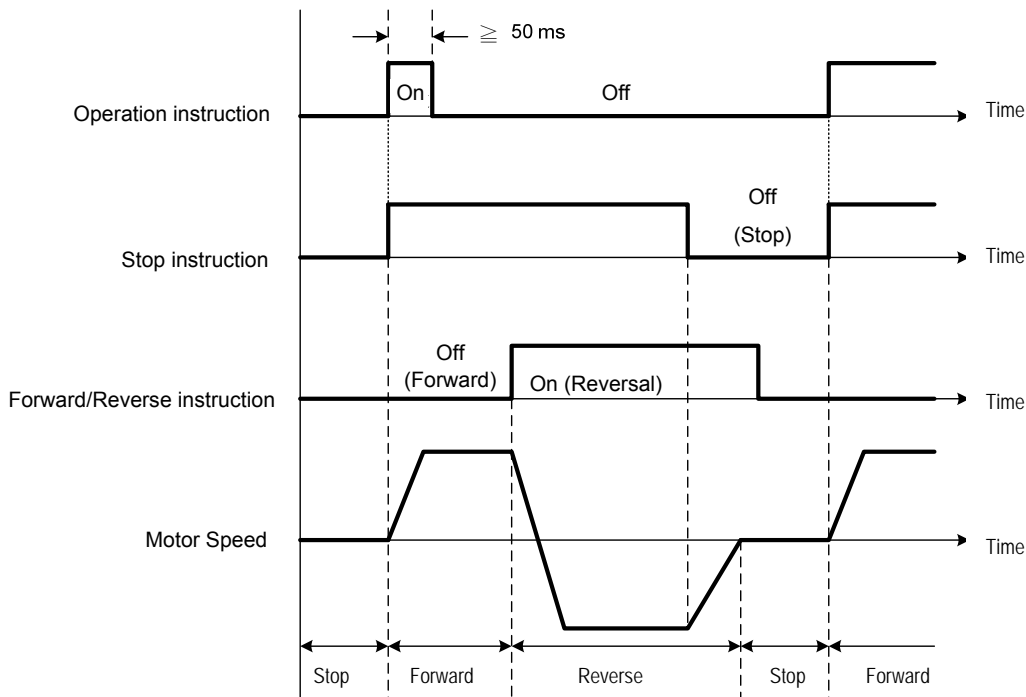

Figure 4.3.3 3-wire operation procedure

(3). 00-02=2

- . The inverter operation can be controlled by using RS-485 communication port.
- . Please refer to parameter 09-- communication group to understand the description of communication details of RS-422/485.

(4). 00-02=3

The inverter operation/stop command and frequency command can be control by the built-in PLC of inverter. At this time, the set values of 00-05 are invalid.

00- 05	Main Frequency Command Source Selection
Range	<b>【0】</b> : Keypad <b>【1】</b> : External control (analog) <b>【2】</b> : Terminal UP / DOWN <b>【3】</b> : Communication control <b>【4】</b> : Pulse input <b>【5】</b> : PID

(1) 00-05= 0:

- . Use the digital operator (as shown in Figure 4.3.4) to directly input frequency reference command, or to change parameters of 05-01 (frequency reference 1) settings. Please refer to section 4.1.4, the screen mode - details of setting the frequency reference.

(2) 00-05=1:

- . From the control circuit terminal AI1 (voltage input) or AI2 (current input, set by 04-00), input the frequency reference command.
- . When the input voltage signal acts as the main frequency reference command, use AI1 terminal.
- . When the input current signal (4-20mA) acts as the main frequency reference command, use AI2 terminal, setting steps are shown as below:
  - ① Input 0V to terminal AI1
  - ② Set 04-00=1: (select the multi-function analog input terminal AI2 signal as the input of 4 ~ 20mA)
  - ③ Set the dip switch SW2 to position I (current).
  - ④ Set 04-05=10 (AI2 signal is increased to AI1).
- . Refer to Figure 4.3.4 so understand the source selection of main speed frequency comes from details of analog terminals setting.

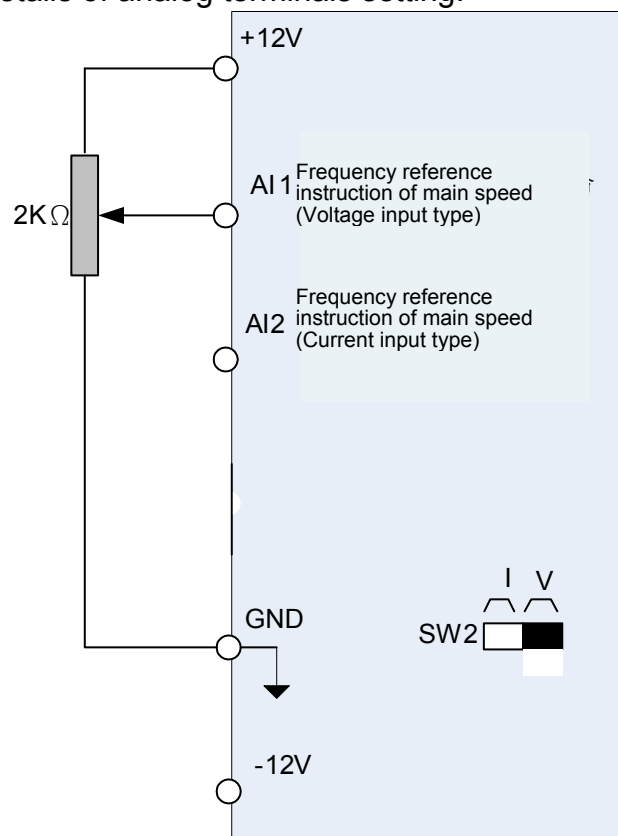

Figure 4.3.4 Analog input of frequency reference command of main speed

**Note -**

1. When inputting current signal to terminal AI 2, turn the voltage / current switch SW2 to I (factory setting), and set 04-00 = 1, or 3 (AI2 = 4 ~ 20mA).
2. When inputting voltage to terminal AI2, turn the voltage / current switch SW2 to V position (factory setting) and set 04-00 = 0, or 2 (AI2 = 0 ~ 10V).
3. Set correctly 04-00 based on AI1 input signal.

(3) 00-05=2:

Use the functions of increasing frequency and decreasing frequency of terminal DI to control frequency command. Please refer to 03-00 ~ -03-07 parameter description to understand the relevant functions.

(4) 00-05=3:

Use the PLC of MODICON series or other related devices using MODBUS RTU protocol to input frequency reference through RS-485 communication port. Please refer to parameter 09-- communication group to understand more communication commands of RS-485.

(5) 00-05=4:

Set 03-30 (pulse input function selection) to 0 (frequency reference), you can use pulse input as frequency reference command and set 03-32 (pulse input ratio) to 100%. Please refer to descriptions of parameters 03-30 ~ 03-34 to understand detailed description of using input pulse. The frequency reference function of pulse input is shown as Figure 4.3.5.

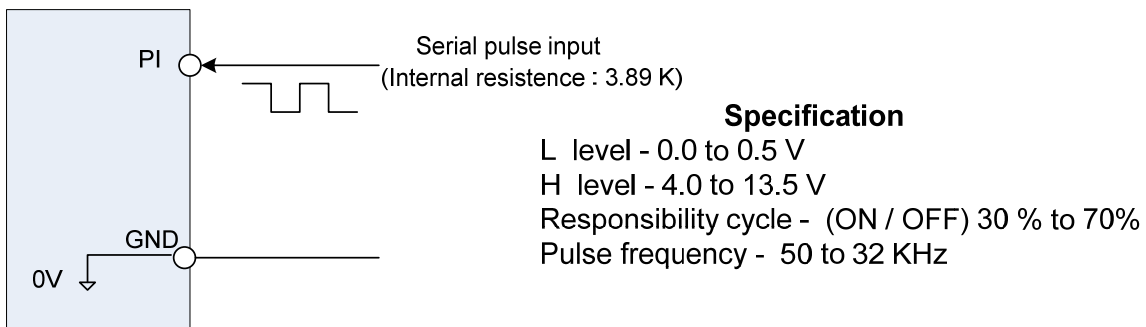

**Figure 4.3.5 The frequency reference function of pulse input**

(6) 00-05=5:

Using PID function as a source of frequency reference, please refer to the relevant descriptions of parameters 10-00 ~ 10-29.

<b>00- 08</b>	Communication frequency command
<b>Range</b>	<b>【0.00~400.00】 Hz</b> <b>【0.0~1200.0】 Hz (when 00-31 = 1)</b>

- This parameter is used to read the communication frequency command (read-only).
- This parameter is only effective in communication mode.

<b>00- 09</b>	Communication frequency command memory
<b>Range</b>	<b>【0】 : Do not store the communication frequency command before power off</b> <b>【1】 : Store the communication frequency command before power off</b>

- This parameter is only effective in communication mode.

<b>00-12</b>	Frequency upper limit
<b>Range</b>	<b>【0.1~109.0】 %</b>
<b>00-13</b>	Frequency lower limit
<b>Range</b>	<b>【0.0~109.0】 %</b>

The upper limit and lower limit of frequency reference is based on maximum 100% of output reference 01-01 (Fmax) or 01-16, with 0.1% as increasing base.

- . Set value of 00-12 shall exceed 00-13, otherwise it will display error information of Range set by "SE01" (Set Range Error).

- . when frequency reference is zero and operation command input, the motor will start to operate against lower limit of frequency reference 00-13 and minimum value of minimum frequency 01-08( or 01-22).
- . Please refer to Figure 4.3.6

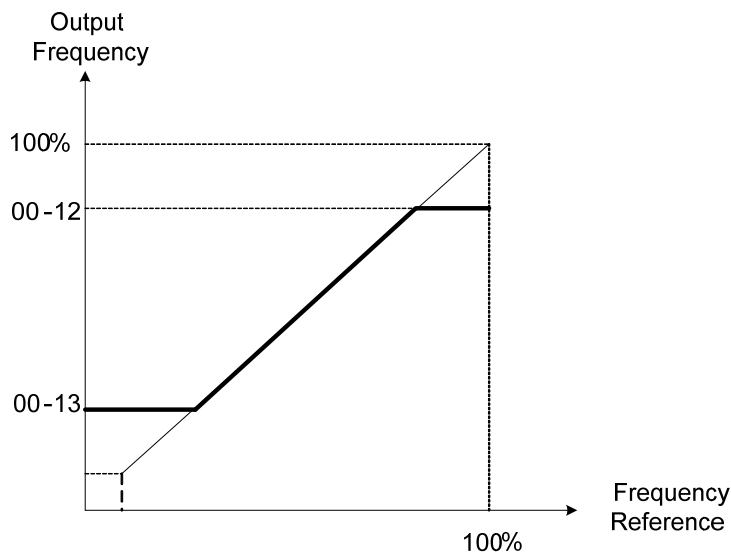

Figure 4.3.6 Upper and lower limits of frequency reference

<b>00-14</b>	Acceleration time 1
<b>Range</b>	<b>【0.1~6000.0】 Sec</b>
<b>00-15</b>	Deceleration time 1
<b>Range</b>	<b>【0.1~6000.0】 Sec</b>
<b>00-16</b>	Acceleration time 2
<b>Range</b>	<b>【0.1~6000.0】 Sec</b>
<b>00-17</b>	Deceleration time 2
<b>Range</b>	<b>【0.1~6000.0】 Sec</b>
<b>00-21</b>	Acceleration time3
<b>Range</b>	<b>【0.1~6000.0】 Sec</b>
<b>00-22</b>	Deceleration time3
<b>Range</b>	<b>【0.1~6000.0】 Sec</b>
<b>00-23</b>	Acceleration time4
<b>Range</b>	<b>【0.1~6000.0】 Sec</b>
<b>00-24</b>	Deceleration time4
<b>Range</b>	<b>【0.1~6000.0】 Sec</b>
<b>00-25</b>	<b>Switching frequency of acceleration and deceleration</b>
<b>Range</b>	<b>【0.00~400.00】 Hz</b> <b>【0.0~1200.0】 Hz ( When 00-31 = 1)</b>

Set each acceleration / deceleration time, acceleration time of default is set to 00-14, while the deceleration time of default is set to 00-15.

- . Accelerate the time: it is the required time from 0% to 100% of maximum output frequency (01-02) or (01-16).
- . Deceleration time: it is the required time from 100% to 0% of maximum output frequency (01-02) or (01-16).

**A. Acceleration / deceleration time switching through the multi-function digital input terminals**

Use the multi-function digital input terminals (S1 ~ S8), based on the ON / OFF status of terminals, select acceleration / deceleration time of operation period. The following table shows the switching combination of acceleration / deceleration time (binary).

**Table 4.3.1 Switching combination of acceleration / deceleration time**

Choice of acceleration / deceleration time 2 (Set 03-00 to 03-07 = 30)	Choice of acceleration / deceleration time 1 (Set 03-00 to 03-07 = 10)	Acceleration time	Deceleration time
0	0	Tacc1(00-14)	Tdec1(00-15)
0	1	Tacc2(00-16)	Tdec2(00-17)
1	0	Tacc3(00-21)	Tdec3(00-22)
1	1	Tacc4(00-23)	Tdec4(00-24)

0 : OFF    1 : ON

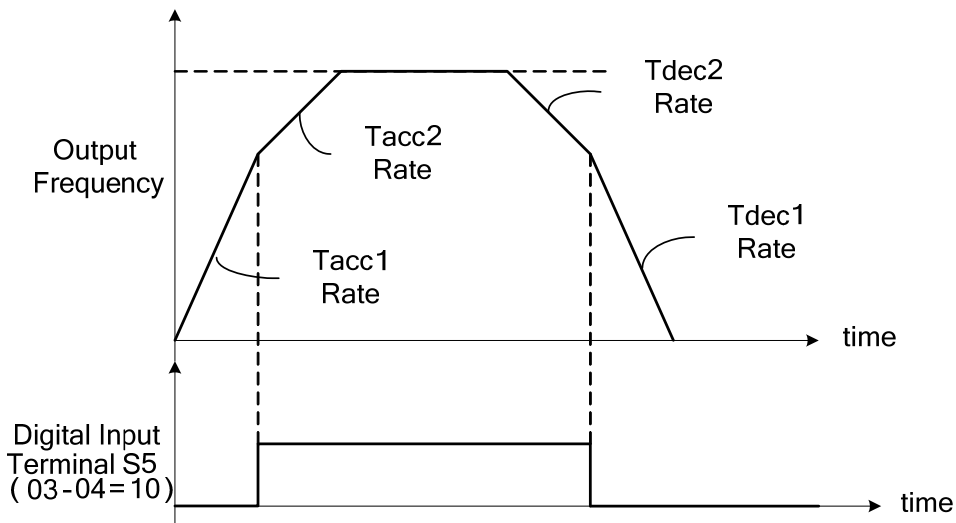

**Figure 4.3.7 Acceleration / deceleration time switching through the multi-function digital input terminals (Example)**

**B. Automatically switch the acceleration / deceleration time**

- . When the output frequency reaches set value of 00-25, it will follow the set frequency of 00-25 to automatically switch the first and the fourth acceleration / deceleration time. Refer to the Figure 4.3.8.

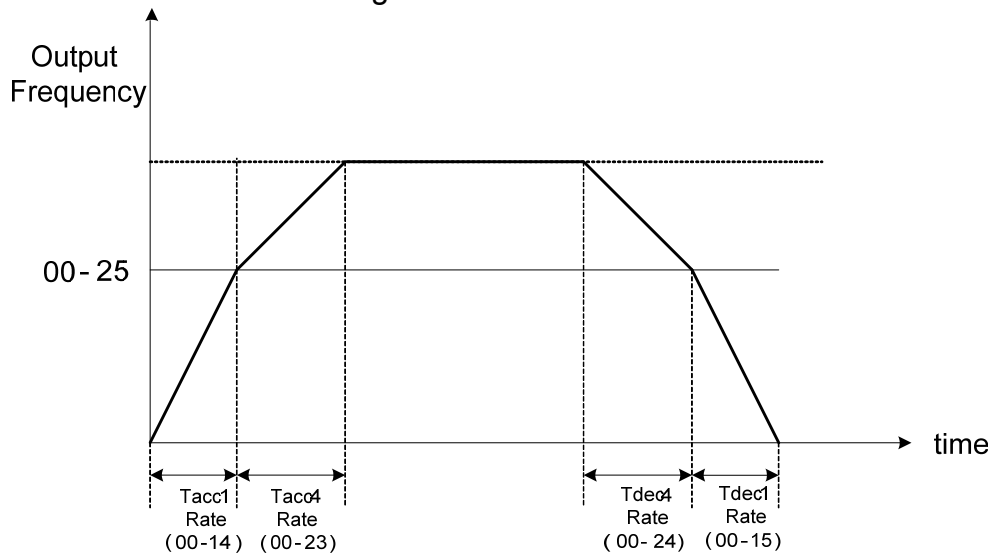

**Figure 4.3.8 Automatically switch acceleration / deceleration**

- . When the output frequency is  $F_{out} < 00-25$ : acceleration / deceleration time = the first acceleration time / the first deceleration time (00-14 and 00-15).
- . When the output frequency is  $F_{out} \geq 00-25$ : acceleration / deceleration time = the fourth acceleration time / the fourth deceleration time (00-23 and 00-24).
- . The choice of multi-function digital input acceleration / deceleration time 1 (03-00 ~ 03-07 are set to 10) and acceleration / deceleration time 2 (set to 30) is prior to 00-25.

<b>00-18</b>	Jog frequency
<b>Range</b>	<b>【0.00~400.00】 Hz</b> <b>【0.0~1200.0】 Hz</b> (when 00-31 = 1)
<b>00-19</b>	Jog acceleration time
<b>Range</b>	<b>【0.1~0600.0】 Sec</b>
<b>00-20</b>	Jog deceleration time
<b>Range</b>	<b>【0.1~0600.0】 Sec</b>

00-19 (jog acceleration time) is set to acceleration time from zero to maximum output frequency (01-02) or (01-16), and 00-20 (jog deceleration time) is set to deceleration time from the maximum output frequency (01-02) or (01-16) to zero. When jog command is effective, 00-18 is set to the jog frequency reference (factory default is set to 6.0Hz).

<b>00-26</b>	Emergency stop time
<b>Range</b>	<b>【0.0~6000.0】 Sec</b>

Use multi-function digital input terminals (S1 ~ S8) to achieve deceleration stop within the set time of 00-26.

- . Multi-function digital input terminals (03-00 ~ 03-07) are set to 14: When the emergency stop contact is ON (normally open), it achieves deceleration stop within the set time of 00-26.



- . Multi-function digital input terminals (03-00 ~ 03-07) are set to 15: When the emergency stop contact is OFF (normally closed), it achieves deceleration stop within the set time of 00-26.
- . After the emergency stop command is input, before the inverter stops, it can not be restarted. If the emergency stop is cancelled, please turn off the operation command and emergency stop command. Please refer to Figure 4.3.9.
- . When errors are detected, this function can be used as a way to stop.

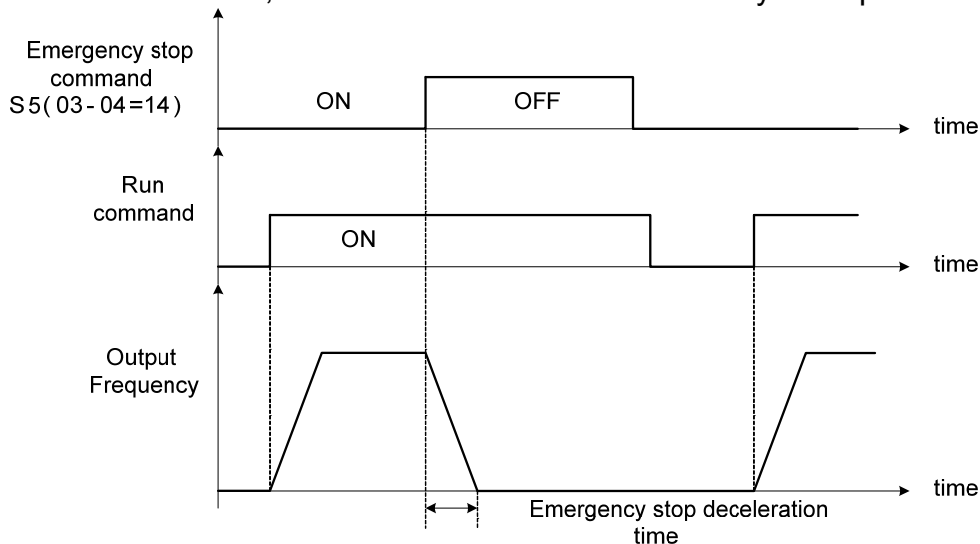

Figure 4.3.9 Examples of emergency stop

<b>00- 27</b>	HD/ND selection
<b>Range</b>	<b>【0】 : HD</b> <b>【1】 : ND</b>

- . In case of selecting heavy load (HD,00-27=0) or normal load (ND, 00-27 = 1), the inverter will automatically change the overload protection curve, carrier frequency, maximum output frequency, stall prevention level and rated input / output current. Please refer to Table 4.3.2.

Table 4.3.2 Constant torque mode / variable torque mode level

00-27 setting	Overload capacity	Carrier frequency	Maximum output frequency	Stall prevention level	Rated input / output current
0 (HD mode)	150%, 1min	2-16KHz (Based on the change of KVA )	400.00Hz	150% (08-00, 08-01)	Refer to section 3.7
1 (ND mode)	120%, 1min	2-16KHz (Based on the change of KVA )	120.00Hz	120% (08-00, 08-01)	

- . When the heavy load mode or normal mode is selected, select the appropriate V / F curve and group 1, group 2, the relevant parameters of motor V / F curve to correspond to the applied load.

Under HD mode, the maximum frequency is 400Hz. but if the control mode is SLV mode, the maximum output frequency will be limited according to the horsepower.

For 220V 1~25HP and 440V 1~30HP, the maximum output frequency is 150Hz

For 220V 30HP and above and 440V 40HP, the maximum output frequency is 100Hz

. ND mode is only applied to V / f and V / f + PG mode. SLV, SV, PMSV and PMSLV modes do not provide a normal load mode.

<b>00- 28</b>	<b>Command characteristic selection of master frequency</b>
<b>Range</b>	<b>【0】</b> : Positive characteristic (0~10V/4~20mA corresponds to 0~100%) <b>【1】</b> : Negative characteristic (0~10V/4~20mA corresponds to 100~0%)

- When inputting analog frequency reference signal from the control terminal AI1 or AI2, select the characteristic of main frequency reference command corresponding to the analog signal.
- 00-28 = 0: Positive characteristic of main frequency reference command.  
(0-10V or 4-20mA /0-100%, -10-0V/-100%-0)  
=1: Negative characteristic of main frequency reference command.
- Please refer to Figure 4.3.10 for the characteristics of the main frequency reference reference

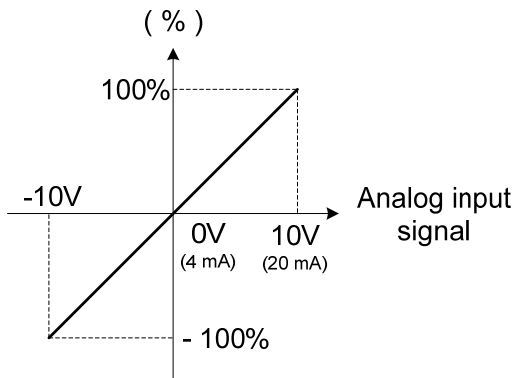

(a) Forward Characteristics

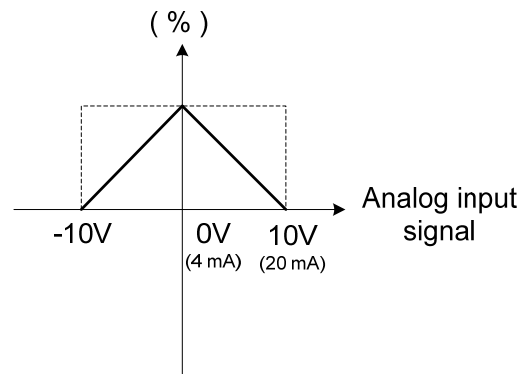

(b) Reverse Characteristics

- **Figure 4.3.10 Positive/Negative characteristic of main frequency reference command.**

<b>00- 29</b>	<b>Zero-speed operation selection</b>
<b>Range</b>	<b>【0】</b> : Operation based on frequency command <b>【1】</b> : Stop <b>【2】</b> : Operation based on lowest frequency <b>【3】</b> : Zero-speed operation

In sensor vector mode (SV / PMSV) (00 - 00 = 3 / 4), when the operation frequency is below the minimum output frequency, as shown in Figure 4.3.11.

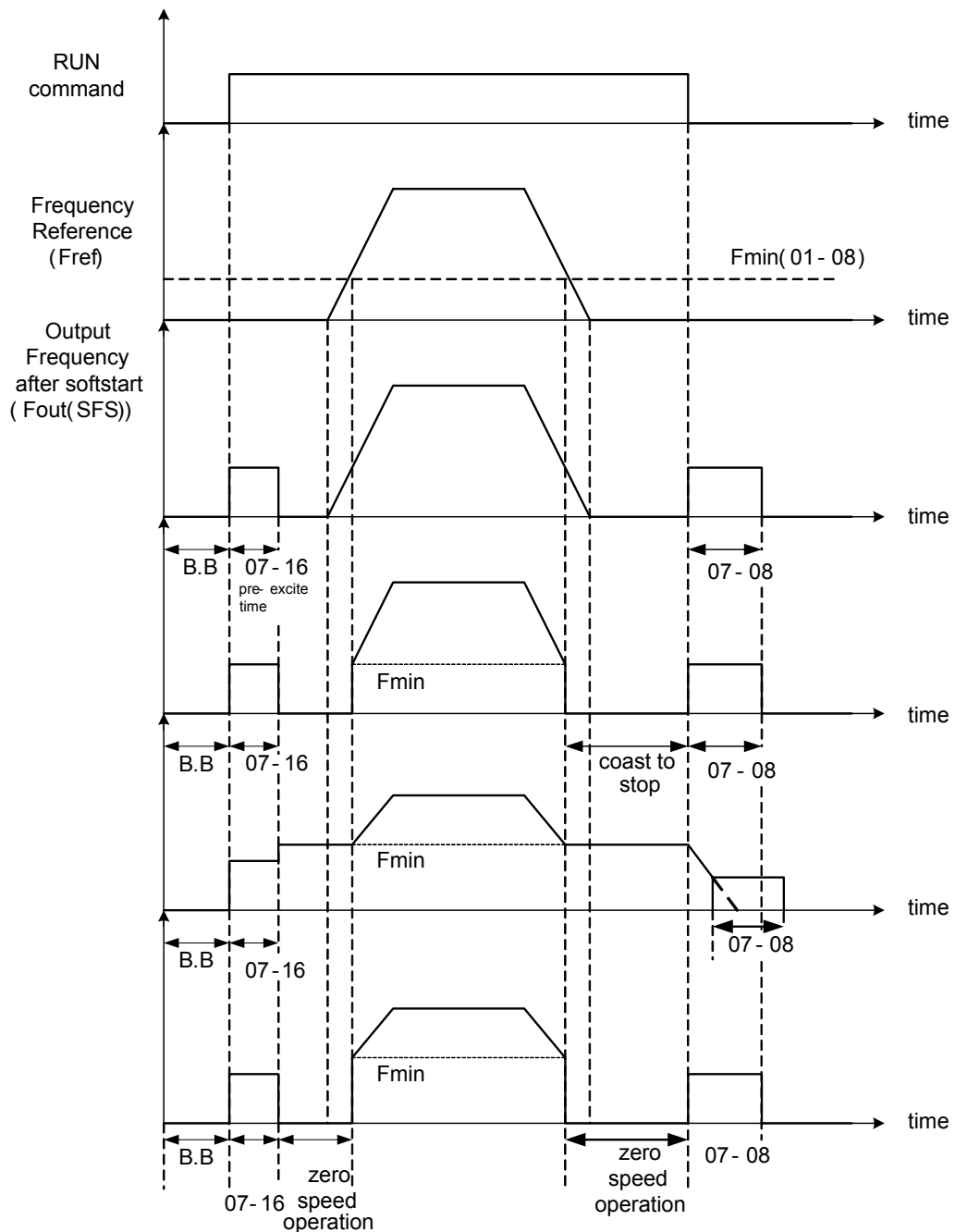

**Figure 4.3.11 Zero-speed operation of sensor vector (SV) mode**

When the operation command (forward or reversal) is OFF, when the output frequency decreases to DC braking start frequency (07-06), and the DC braking will perform this function based on the DC braking execution time (07-08), please refer to Figure 4.3.62 to understand the operational details of pre-excitation operation.

<b>00- 31</b>	Maximum frequency
<b>Range</b>	<b>【0】</b> : 400.00Hz <b>【1】</b> : 1200.0Hz

The maximum output frequency Range of the inverter can be set by selecting 400Hz or 1200Hz for parameter 00-31. When setting actual panel frequency, it requires adjusting the maximum output frequency of motor 1 of parameter 01-02 or the maximum output frequency of motor 2 of parameter 01-16.

<b>00- 32</b>	Application adjustment
<b>Range</b>	<b>【0】</b> : Disable <b>【1】</b> : Water supply pump <b>【2】</b> : Conveyor <b>【3】</b> : Exhaust fan <b>【4】</b> : HVAC <b>【5】</b> : Compressor <b>【6】</b> : Hoist <b>【7】</b> : Crane

### (1). Water supply pump

Parameter	Name	Optimal value
00-00	Control mode selection	0 : V/F
11-00	<b>Direction Lock Selection</b>	1 : Only allow forward rotation
00-14	Acceleration time 1	1.0 sec
00-15	Deceleration time 1	1.0 sec
00-27	HD/ND selection	1 : ND
01-00	V/F curve selection	F
01-04	Middle output frequency 2 of motor 1	30.0 Hz
01-05	Middle output voltage 2 of motor 1	60.0 V
07-00	Momentary stop and restart selection	1 : valid
08-00	Stall prevention function	xx0xb : Stall prevention is valid in deceleration

### (2). Conveyor

Parameter	Name	Optimal value
00-00	Control mode selection	0 : V/F
00-14	Acceleration time 1	3.0 sec
00-15	Deceleration time 1	3.0 sec
00-27	HD/ND selection	0 : HD
08-00	Stall prevention function	xx0xb : Stall prevention is valid in deceleration

### (3). Exhaust fan

Parameter	Name	Optimal value
00-00	Control mode selection	0 : V/F
11-00	Direction Lock Selection	1 : Only allow forward rotation
00-27	HD/ND selection	1 : ND
01-00	V/F curve selection	F
01-04	Middle output frequency 2 of motor 1	30.0 Hz
01-05	Middle output voltage 2 of motor 1	50.0 V

07-00	Momentary stop and restart selection	1 : valid
08-00	Stall prevention function	xx0xb : Stall prevention is valid in deceleration

#### (4). HVAC

Parameter	Name	Optimal
00-00	Control mode selection	0 : V/F
11-00	Direction Lock Selection	1 : Only allow forward rotation
00-27	HD/ND selection	1 : ND
11-01	Carrier frequency	8.0kHz
07-00	Momentary stop and restart selection	1 : Valid
11-03	Selection of reducing carrier automatically	1 : Valid

#### (5). Compressor

Parameter	Name	Optimal
00-00	Control mode selection	0 : V/F
11-00	Direction Lock Selection	1 : Only allow forward rotation
00-14	Acceleration time 1	5.0 sec
00-15	Deceleration time 1	5.0 sec
00-27	HD/ND selection	0 : HD
01-00	V/F curve selection	F
07-00	Momentary stop and restart selection	1 : Valid
08-00	Stall prevention function	xx0xb : Stall prevention is valid in deceleration

#### (6). Hoist

Parameter	Name	Optimal
00-00	Control mode selection	2 : SLV
00-05	Main Frequency Command Source Selection	0 : keypad
11-43	Hold Frequency at start	3.0 Hz
11-44	Frequency hold Time at start	0.3 sec
00-14	Acceleration time 1	3.0 sec
00-15	Deceleration time 1	3.0 sec
00-27	HD/ND selection	0 : HD
11-01	Carrier frequency	5.0kHz
05-01	Frequency setting of speed-stage 0	6.0 Hz
06-01	Frequency setting of speed-stage 1	30.0 Hz
06-02	Frequency setting of speed-stage 2	60.0 Hz
01-00	V/F curve selection	F
03-28	Optocoupler output	5 : frequency detection 2
07-18	Minimum Baseblock Time	0.3 sec
08-00	Stall prevention function	xx1x : Stall prevention ineffective in deceleration
03-13	Frequency detection level	2.0 Hz
03-14	Frequency detection width	0.0 Hz
08-18	Selection of low-torque operation	0: Deceleration to stop when low torque is detected.
08-19	Level of low-torque detection	2 %
08-20	Time of low-torque detection	0.5 sec

08-09	Selection of input phase loss protection	1 : Valid
08-10	Selection of output phase loss protection	1 : Valid
11-03	Selection of reducing carrier automatically	1 : Valid

**(7). Crane**

<b>Parameter</b>	<b>Name</b>	<b>Optimal</b>
00-00	Control mode selection	0 : V/F
00-05	Main Frequency Command Source Selection	0 : keypad
00-14	Acceleration time 1	3.0 sec
00-15	Deceleration time 1	3.0 sec
00-27	HD/ND Mode selection	0 : HD
11-01	Carrier frequency	5.0kHz
05-01	Frequency setting of speed-stage 0	6.0 Hz
06-01	Frequency setting of speed-stage 1	30.0 Hz
06-02	Frequency setting of speed-stage 2	60.0 Hz
03-04	Multi-function terminal Function setting-S5	2 : Multi-speed/position setting command 1
03-05	Multi-function terminal Function setting-S6	3 : Multi-speed/position setting command 2
03-28	Optocoupler output	23 : Source of operation command
08-00	Stall prevention function	xx1x : Stall prevention ineffective in deceleration
08-09	Selection of input phase loss protection	1 : Valid
08-10	Selection of output phase loss protection	1 : Valid

## 01-V/F Control Function Group

<b>01-00</b>	<b>V/F curve selection</b>
<b>Range</b>	<b>【0~FF】</b>

When V / F mode without PG or V / F mode with PG is applied, V / F characteristic of inverter output can be set at 01-00.

. When using V / f curve, the inverter input voltage must be set by 01-14.

. There are three ways to set V / f curve:

(1) 01-00 = 0 to E: choose the 15 default types (0 to E).

(2) 01-00 = 0F, use 01-02~01-09 and 01-12~01-13, for users to define V/f curve with voltage limitation.

(3) 01-00 = FF: use 01-02~01-09 and 01-12~01-13, for users to define V/f curve without voltage limitation.

. The default setting of 01-00 is F, and when 01-00 is set to 1, 01-02~01-09 and 01-12~01-13 have the same contents.

. When you select one of the 15 default types, the set values from 01-02 to 01-13 will be automatically changed. There are three types of set values for 01-12 ~ 01~ 01-09 and 01-02 ~01-13. Their values are determined by the inverter capacity.

. Refer to the V / F characteristics in ~ 4.3.5.

This parameter is not affected by the initialization parameter (13-08).

**Table 4.3.3 1 - 2HP V/f curve**

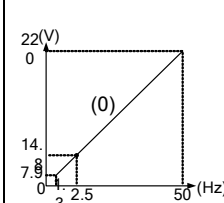
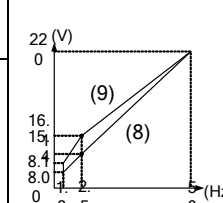
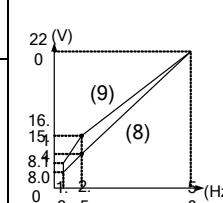
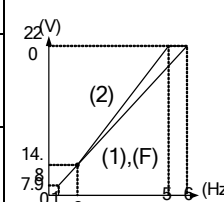
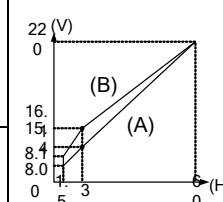
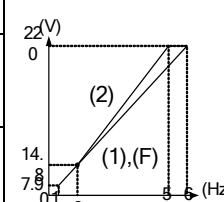
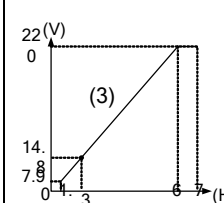
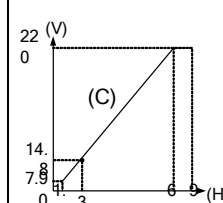
Type	Specification	01-00 setting	V/F curve *1	Type	Specification	01-00 setting	V/F curve *1	
General application	50Hz	0		High start torque	50Hz	Small start torque	8	
			Large start torque			9		
	60Hz	1 F (original value)			60Hz	Small start torque	A	
			50Hz Saturation			2		Large start torque
Descending torque (Mechanics of wind, water and other force)	72Hz	3		Constant-power torque(Reducer)	90Hz	C		
			50Hz Cubic descending curve				4	

		Quadratic descending curve	5				
	60Hz	Cubic descending curve	6		180Hz	E	
		Quadratic descending curve	7				

Type	Specification	01-00 setting	V/F curve <sup>*1</sup>
High speed motor	1200Hz	F ( need to set 00-31 to 1 )	

\*1. These values are for 220V series inverters; Two times of these values are for 440V series inverters.



Table 4.3.4 3 - 30HP V/f curve

Type	Specification	01-00 setting	V/F curve *1	Type	Specification	01-00 setting	V/F curve *1			
General application	50Hz	0		High start torque	Small start torque	8				
			Large start torque		9					
	60Hz	60Hz Saturation	1 F (original value)			Small start torque	A			
		50Hz Saturation	2			Large start torque	B			
Descending torque (Mechanics of wind, water and other force)	72Hz	3		Constant-power torque (Reducer)	90Hz	C				
			50Hz				Cubic descending curve	4		120Hz
	Quadratic descending curve	5						180Hz	E	
	60Hz	Cubic descending curve	6			60Hz	7			
		Quadratic descending curve	7							

Type	Specification	01-00 setting	V/F curve *1
High speed motor	1200Hz	F ( need to set 00-31 to 1 )	

\*1. These values are for 220V series inverters; Two times of these values are for 440V series inverters.

Table 4.3.5 V/f curve of series above 40HP

Type	Specification	01-00 setting	V/F curve *1	Type	Specification	01-00 setting	V/F curve *1	
General application	50Hz	0		High start torque	Small start torque	8		
					Large start torque	9		
	60Hz	60Hz Saturation	1 F (original value)			Small start torque	A	
		50Hz Saturation	2			Large start torque	B	
Descending torque (Mechanics of wind, water and other force)	72Hz	3		Constant-power torque(Reducer)	90Hz	C		
								50Hz
	Quadratic descending curve	5	180Hz		E			
	60Hz	Cubic descending curve					6	
		Quadratic descending curve	7					

\*1. These values are for 220V series inverters; Two times of these values are for 440V series inverters.

\*2. Series above 40HP do not support high-speed motor

<b>01-02</b>	Maximum output frequency of motor 1
<b>Range</b>	<b>【40.0~400.0】 Hz</b> <b>【40.0~1200.0】 Hz</b> (when 00-31 = 1)
<b>01-03</b>	Maximum output voltage of motor 1
<b>Range</b>	220V: <b>【0.1~255.0】 V</b> 400V: <b>【0.2~510.0】 V</b>
<b>01-04</b>	Middle output frequency 2 of motor 1
<b>Range</b>	<b>【0.0~400.0】 Hz</b> <b>【0.0~1200.0】 Hz</b> (when 00-31 = 1)
<b>01-05</b>	Middle output voltage 2 of motor 1
<b>Range</b>	220V: <b>【0.0~255.0】 V</b> 400V: <b>【0.0~510.0】 V</b>
<b>01-06</b>	Middle output frequency 1 of motor 1
<b>Range</b>	<b>【0.0~400.0】 Hz</b> <b>【0.0~1200.0】 Hz</b> (when 00-31 = 1)
<b>01-07</b>	Middle output voltage 1 of motor 1
<b>Range</b>	220V: <b>【0.0~255.0】 V</b> 400V: <b>【0.0~510.0】 V</b>
<b>01-08</b>	Minimum output frequency of motor 1
<b>Range</b>	<b>【0.0~400.0】 Hz</b> <b>【0.0~1200.0】 Hz</b> (when 00-31 = 1)
<b>01-09</b>	Minimum output voltage of the motor 1
<b>Set Range</b>	220V: <b>【0.0~255.0】 V</b> 400V: <b>【0.0~510.0】 V</b>
<b>01-12</b>	Base frequency of motor 1
<b>Set Range</b>	<b>【10.0~400.0】 Hz</b> <b>【10.0~1200.0】 Hz</b> (when 00-31 = 1)
<b>01-13</b>	Base output voltage of motor 1
<b>Set Range</b>	220V: <b>【0.0~255.0】 V</b> 400V: <b>【0.0~510.0】 V</b>

#### V/f curve setting (01-02~01-09 and 01-12~01-13)

- Only when 01-00 has been set to "F" or "FF", users can set 01-02 ~ 01-13 ~ 01-09 and 01-12. If 01-00 is set to any other value but not F or FF, the parameter can not be changed. Please follow the rules of the frequency setting, or the warning message "SE03" of V / f curve tuning error will be displayed.

$$F_{\max} > F_{\text{base}} > F_{\text{mid2}} > F_{\text{mid1}} > F_{\min}$$

$$(01-02) \quad (01-12) \quad (01-04) \quad (01-06) \quad (01-08)$$

- If 01-04 and 01-05 (or 01-18 and 01-09) are set to 0, the program will ignore the set values of Fmin2 and Vmin2 .
- There are not relevant rules for voltage setting (from 01-02 to 01-09).
- If the control mode is changed through 00-00 , parameters 01-08(F<sub>min</sub>) and 01-09 (V<sub>min</sub>) will change the default settings of various control mode.
- Refer to the following V / F curve defined by users.

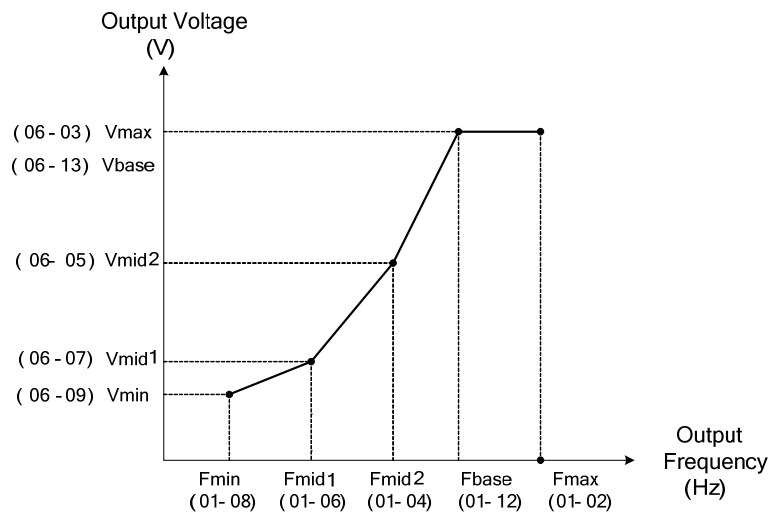

**Figure 4.3.12 V/F curve defined by users**

- Set the V / F curve based on the allowed load characteristic of the motor. In the application of low torque and high speed, the motor may overheat. If the motor operates under this condition for long time, you have to pay special attention to the motor cooling.
- If the automatic torque boosting function is started by parameter 01-10, starting and operating under the condition of low frequency, the motor voltage will automatically change to provide adequate motor torque.

### SV (Sensor vector control) V/F curve setting

- . In SLV control mode, you do not need to adjust V / F curve in general. Changing maximum output frequency settings 01-02 (Fmax), base frequency 01-12 (Fbase), minimum output frequency 01-08 (Fmin), maximum output voltage 01-03 (Vmax) or base output voltage 01-13 (Vbase) can adjust the V / F curve.
- . Because SV / SLV mode uses current controller, so in the SV / SLV mode, group 01 only adjust the frequency curve and the voltage has been adjusted by the current controller. Regardless of motor operation at rated power range or higher, you can use parameters 02-19 or 17-04 to reduce the voltage set value without load, and re-perform automatic parameter tuning in order to achieve magnet pre-weakening procedure. The adjustment range of voltage without load is about 10 ~ 40V. After the voltage without load is reduced, the jitter can be prevented. The only drawback of magnet weakening control is that the current will become larger.
- . In SLV mode, the base frequency (01-12, Fbase) needs to set the rated frequency on the motor nameplate.

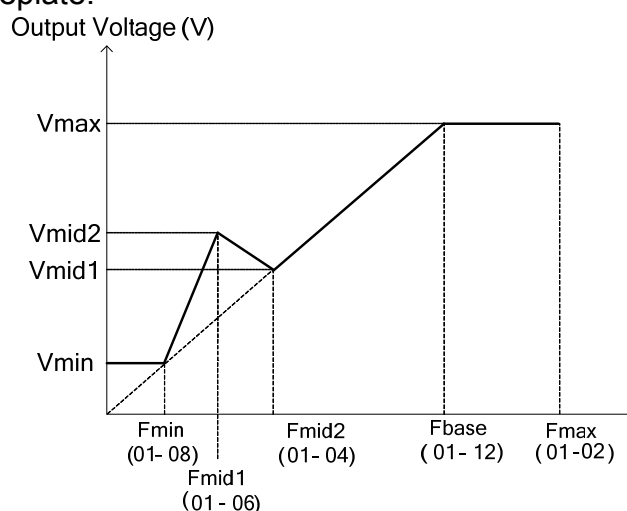
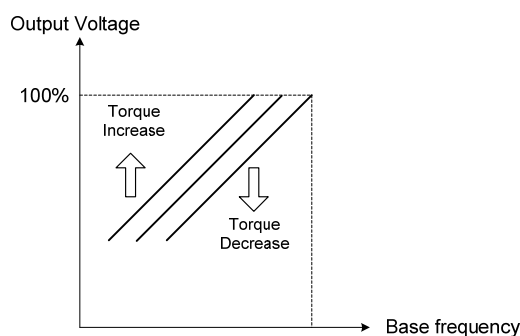

Figure 4.3.13 Torque boosting

<b>01-10</b>	Torque compensation gain
<b>Range</b>	<b>【0.0~2.0】</b>

Torque compensation gain (01-10)

- . In V / F or V / F + PG mode: The inverter's compensation voltage is calculated by the loss of motor voltage.
- . Torque compensation gain (01-10) can be modified in the operation, but usually it is not required to modify, except the following situations:
  - If the wiring between the inverter and the motor is too long, increase the set value.
  - If the motor capacity is smaller than the inverter capacity, increase the set value.
  - In case of motor vibration, reduce the set value.
- . Gradually increase set value of 01-10 and confirm the current increment will not exceed.
- . Confirm that the output current at low speed does not exceed the rated output current of inverter. Refer to the torque compensation gain adjustment shown in Figure 4.3.14.



**Figure 4.3.14 Tune torque compensation gain to increase output torque**

<b>01-14</b>	Input voltage setting
<b>Range</b>	220V: <b>【155.0~255.0】 V</b> 400V: <b>【310.0~510.0】 V</b>

Set the inverter voltage by the unit of 0.1V to match the input power (such as. 200V / 208V / 230V / 240V or 380V / 415V / 440V / 460V / 480V).

This setting is used as a reference for pre-defining V / f curve (01-00 = 0 to E) and protection for over-voltage, stall prevention and so on.

<b>01-15</b>	Torque compensation time
<b>Range</b>	<b>【1~10000】 ms</b>

Torque compensation time (01-15)

. Set the torque compensation delay time by the unit of millisecond.

. In general, there is no need to do adjustments, except the following situations:

- In case of motor vibration, increase the setting.
- If the motor response is too slow, reduce the setting.

<b>01- 16</b>	Maximum output frequency of motor 2
<b>Range</b>	<b>【40.0~400.0】 Hz</b> <b>【40.0~1200.0】 Hz</b> (when 00-31 = 1)
<b>01- 17</b>	Maximum output voltage of motor 2
<b>Range</b>	220V: <b>【0.1~255.0】 V</b> 400V: <b>【0.2~510.0】 V</b>
<b>01- 18</b>	Middle output frequency 2 of motor 2
<b>Range</b>	<b>【0.0~400.0】 Hz</b> <b>【0.0~1200.0】 Hz</b> (when 00-31 = 1)
<b>01- 19</b>	Middle output voltage 2 of motor 2
<b>Range</b>	220V: <b>【0.0~255.0】 V</b> 400V: <b>【0.0~510.0】 V</b>
<b>01- 20</b>	Middle output frequency 1 of motor 2
<b>Range</b>	<b>【0.0~400.0】 Hz</b> <b>【0.0~1200.0】 Hz</b> (when 00-31 = 1)
<b>01- 21</b>	Middle output voltage 1 of motor 2
<b>Range</b>	220V: <b>【0.0~255.0】 V</b> 400V: <b>【0.0~510.0】 V</b>
<b>01- 22</b>	Minimum output frequency of motor 2
<b>Range</b>	<b>【0.0~400.0】 Hz</b> <b>【0.0~1200.0】 Hz</b> (when 00-31 = 1)
<b>01-23</b>	Minimum output voltage of motor 2
<b>Set Range</b>	220V: <b>【0.0~255.0】 V</b> 400V: <b>【0.0~510.0】 V</b>
<b>01- 24</b>	Base frequency of motor 2

<b>Set Range</b>	<b>【10.0~400.0】 Hz</b> <b>【10.0~1200.0】 Hz</b> (when 00-31 = 1)
<b>01- 25</b>	Base voltage of motor 2
<b>Set Range</b>	220V: <b>【0.0~255.0】 V</b> 400V: <b>【0.0~510.0】 V</b>

Set V/F curve of motor 2. The setting way is the same as that of motor 1.

## 02 - IM Motor Parameter Group

<b>02- 00</b>	No-load current of motor 1
<b>Range</b>	<b>【0.01~600.00】 A</b>
<b>02- 01</b>	Rated current of motor 1
<b>Range</b>	<b>Modes of V/F、V/F+PG are 10%~200% of inverter's rated current. Modes of SLV、SV are 25%~200% of inverter's rated current.</b>
<b>02-03</b>	Rated rotation speed of motor1
<b>Range</b>	<b>【0~60000】 rpm</b>
<b>02- 04</b>	Rated voltage of motor1
<b>Range</b>	<b>220V: 【50.0~240.0】 V 440V: 【100.0~480.0】 V</b>
<b>02- 05</b>	Rated power of motor 1
<b>Range</b>	<b>【0.01~600.00】 KW</b>
<b>02-06</b>	Rated frequency of motor 1
<b>Range</b>	<b>【10.0~400.0】 Hz 【10.0~1200.0】 Hz (when 00-31 = 1)</b>
<b>02-07</b>	Pole of motor 1
<b>Range</b>	<b>【2,4,6,8】</b>
<b>02-09</b>	Excitation current of motor 1
<b>Range</b>	<b>【10.0~100.0】 %</b>
<b>02-10</b>	Core saturation coefficient 1 of motor 1
<b>Range</b>	<b>【0~100】 %</b>
<b>02-11</b>	Core saturation coefficient 2 of motor 1
<b>Range</b>	<b>【0~100】 %</b>
<b>02-12</b>	Core saturation coefficient 3 of motor 1
<b>Range</b>	<b>【80~300】 %</b>
<b>02-13</b>	Core loss of motor 1
<b>Range</b>	<b>【0.0~15.0】 %</b>
<b>02-15</b>	Resistance between wires of motor 1
<b>Range</b>	<b>【0.001~60.000】 Ω</b>
<b>02-16</b>	Rotor resistance of motor 1
<b>Range</b>	<b>【0.001~60.000】 Ω</b>
<b>02-17</b>	Leakage inductance of motor 1
<b>Range</b>	<b>【0.01~200.00】 Mh</b>
<b>02-18</b>	Mutual inductance of motor 1
<b>Range</b>	<b>【0.1~6553.5】 mH</b>
<b>02-19</b>	No-Load Voltage of motor 1
<b>Range</b>	<b>220V: 【50~240】 V 440V: 【100~480】 V</b>

Motor parameters settings are shown as below. When selecting motor 1 in the period of motor parameters tuning, these motor parameters are automatically set (17-10 = 1). In general, there is no need to do adjustment, except some special applications such as fixed-horsepower control of axis motor of machine tool and so on.

For permanent magnet motor parameters settings, please refer to Group 22

(1) Setting of motor pole number (02-07)



- . Set the number of motor pole as written on motor nameplate.
- (2) Motor rated power (02-05)
  - . Set the power value on motor nameplate.
- (3) Motor rated current (02-01)
  - . Set the full-load current on motor nameplate.
- (4) Motor rated voltage (02-04)
  - Set the rated voltage on motor nameplate.
- (5) Rated frequency of motor 1 (02-06)
  - Set the frequency on motor nameplate.
- (6) Rated rotation speed of motor 1 (02-03)
  - Set the rotation speed on motor nameplate.
- (7) Voltage of motor without load (02-19)
  - . if parameters 17-08 or 02-19 have been set, this parameter is the same as that of 17-08. This parameter determines the rated flux at motor's rated rotation in SLV or SV control mode. Settings below input voltage of 10~50V can ensure that the motor is capable of providing torque performance when the motor operates at rated rotation speed (or higher speed).
  - . The smaller voltage without load can reduce the current without load, weaken flux and increase current with load; while larger voltage without load is opposite.
- (8) Motor excitation current (02-09)
  - This parameter is automatically set by the auto-tuning function. In general, no need to tune it.
- (9) Setting of motor core's saturation coefficient 1,2 and3 (02-10,02-11,02-12)
  - . This parameter is automatically set by the auto-tuning function. In general, no need to tune it.
  - . This parameter sets 50% (02-10),75% (02-11),137.5%(02-12) of motor core's saturation coefficient in order to reduce the impact from core saturation.
  - . Motor core's saturation coefficient is the percentage of the motor excitation current. When the flux reaches 137.5% level, the core's saturation coefficient shall greater than 137.5%. when the flux is 50% or 75%, the core's saturation coefficient is required to less than 50% and 75%。
- (10) Motor core's loss setting(02-13)
  - . Set motor core loss as the percentage of the rated output power of motor.
  - $$\% W_{\text{core}} (02-13) = \frac{3 \times \text{motor core loss (watt)}}{\text{Rated output power of motor (watt , 02-05)}} \times 100\%$$
  - . in V/F control mode, the setting of motor core loss (02-13) is used to compensate the torque accuracy.
- (11) Resistance R1between wires of motor (02-15).
- (12) Leakage inductance of motor Llk (02-17).
- (13) Mutual inductance of motor Lm (02-18).
- (14) Motor rotor's equivalent resistance R2 (02-16).
- (15) Current of motor without load (02-00).
  - . This set value is calculated according to the motor rated frequency (17-05) and the motor rated current (17-03)
  - . In V / F control mode, the output current is greater than the motor current without load, slip compensation is enabled.
  - . 02-01 must be greater than 02-00, otherwise a warning message "SE01" of range error will be displayed.
  - . Refer to Y-equivalent model of the induction motor shown in Figure 4.3.15.

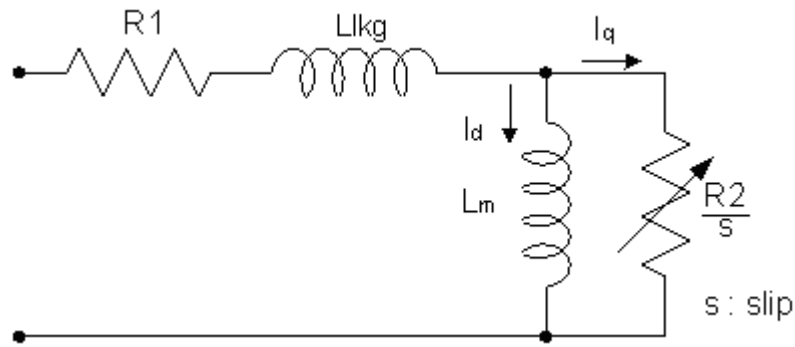

Figure 4.3.15 Y-equivalent model of the induction motor

<b>02- 20</b>	No-Load Current of motor2
<b>Range</b>	<b>【0.01~600.00】 A</b>
<b>02- 21</b>	Rated current of motor 2
<b>Range</b>	10%~200% of inverter's rated current
<b>02-22</b>	Rated rotation speed of motor 2
<b>Range</b>	<b>【0~ 60000】 rpm</b>
<b>02- 23</b>	Rated voltage of motor 2
<b>Range</b>	<b>220V: 【50.0~240.0】 V</b> <b>440V: 【100.0~480.0】 V</b>
<b>02- 24</b>	Rated power of motor 2
<b>Range</b>	<b>【0.01~600.00】 KW</b>
<b>02-25</b>	Rated frequency of motor 2
<b>Range</b>	<b>【10.0~400.0】 Hz</b> <b>【10.0~1200.0】 Hz (when 00-31 = 1)</b>
<b>02-26</b>	Pole of motor 2
<b>Range</b>	<b>【2,4,6,8】</b>
<b>02-32</b>	Resistance between wires of motor 2
<b>Range</b>	<b>【0.001~60.000】 Ω</b>

Parameter setting of motor 2 is the same as that of motor 1. The control mode of motor 2 is fixed to V/f mode, therefore, the parameter requiring to be set is less.

### 03- External Terminals Digital Input/Output Function Group

<b>03- 00</b>	Multi-function terminal function setting – S1
<b>03- 01</b>	Multi-function terminal function setting – S2
<b>03- 02</b>	Multi-function terminal function setting – S3
<b>03- 03</b>	Multi-function terminal function setting – S4
<b>03- 04</b>	Multi-function terminal function setting – S5
<b>03-05</b>	Multi-function terminal function setting – S6
<b>03-06</b>	Multi-function terminal function setting – S7
<b>03-07</b>	Multi-function terminal function setting – S8
<b>Range</b>	<p> <b>【0】</b> : 2-Wire sequence (ON : Forward run command)  <b>【1】</b> : 2-Wire sequence (ON : Reverse run command)  <b>【2】</b> : Multi-speed/position setting command 1  <b>【3】</b> : Multi-speed/position setting command 2  <b>【4】</b> : Multi-speed/position setting command 3  <b>【5】</b> : Multi-speed/position setting command 4  <b>【6】</b> : Forward jog run command  <b>【7】</b> : Reverse jog run command  <b>【8】</b> : UP frequency increasing command  <b>【9】</b> : DOWN frequency decreasing command  <b>【10】</b> : Acceleration/deceleration setting command 1  <b>【11】</b> : Inhibit Acceleration/deceleration Command  <b>【12】</b> : Retain  <b>【13】</b> : Retain  <b>【14】</b> : Emergency stop (decelerate to zero and stop)  <b>【15】</b> : External Baseblock Command(rotation freely to stop)  <b>【16】</b> : PID control disable  <b>【17】</b> : Fault reset (RESET)  <b>【18】</b> : Retain  <b>【19】</b> : Speed Search 1 (from the maximum frequency)  <b>【20】</b> : Manual energy saving function  <b>【21】</b> : PID integral reset  <b>【22】</b> : Retain  <b>【23】</b> : Retain  <b>【24】</b> : PLC input  <b>【25】</b> : External fault  <b>【26】</b> : 3-Wire sequence (Forward/Reverse command)  <b>【27】</b> : Local/Remote selection  <b>【28】</b> : Remote mode selection  <b>【29】</b> : Jog frequency selection  <b>【30】</b> : Acceleration/deceleration setting command 2  <b>【31】</b> : Inverter overheating warning  <b>【32】</b> : Sync command  <b>【33】</b> : DC braking  <b>【34】</b> : Speed Search 2 (from the frequency command)  <b>【35】</b> : Time function input  <b>【36】</b> : PID Soft start invalid  <b>【37】</b> : Traversing operation  <b>【38】</b> : Upper Deviation of traverse operation  <b>【39】</b> : Lower Deviation of traverse operation  <b>【40】</b> : Switching between motor 1/motor 2 </p>

<p> <b>【41】</b> : Retain  <b>【42】</b> : PG invalid  <b>【43】</b> : PG integral reset  <b>【44】</b> : Mode switching between speed and torque  <b>【45】</b> : Negative torque command  <b>【46】</b> : Zero-Servo Command  <b>【47】</b> : Fire Mode  <b>【48】</b> : KEB acceleration  <b>【49】</b> : Parameter writing allowable  <b>【50】</b> : Unattended Start Protection (USP)  <b>【51】</b> : Mode switching between speed and position </p>
--

· Refer to the multi-function digital input and relevant parameter in the following figure 4.3.16.

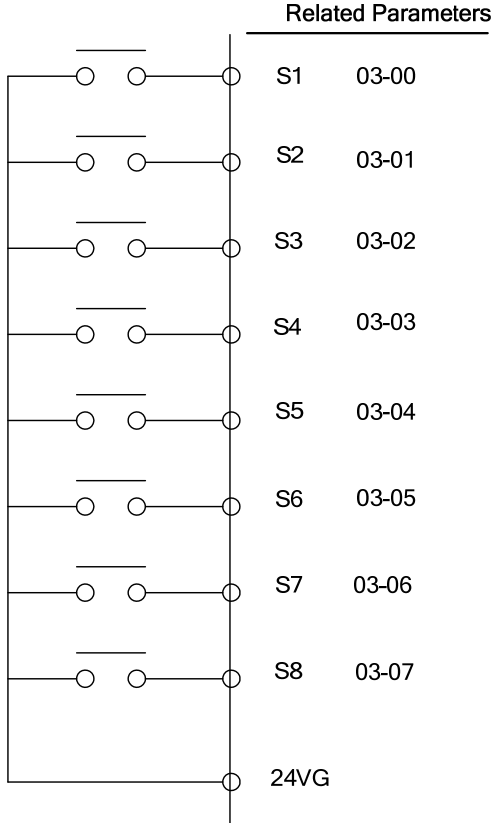

Figure 4.3.16 Multi-function digital input and relevant parameter

**Table 4.3.6 Multi-function digital input setting ( 03-00 to 03-07 ) (“O”: Valid, “X”: invalid)**

Setting	Function		Description	Control mode					Ref. page
	Name	LCD Display		V/F	V/F + PG	SLV	SV	PM SV	
0	2-wire type (Forward operation)	2-Wire (FWD-RUN)	2- wire (ON : Forward operation command).	O	O	O	O	O	
1	2-wire type (Reverse operation)	2-Wire (REV-RUN)	2- wire (ON : Reverse operation command).	O	O	O	O	O	
2	Multi-speed/position setting command 1	Muti-Spd/Pos Ref 1	Multi-Speed Reference /Position Reference 1。	O	O	O	O	O	
3	Multi-speed/position setting command 2	Muti-Spd/Pos Ref 2	Multi-Speed Reference /Position Reference 2	O	O	O	O	O	
4	Multi-speed/position setting command 3	Muti-Spd/Pos Ref 3	Multi-speed Reference /Position Reference 3	O	O	O	O	O	
5	Multi-speed/position setting command 4	Muti-Spd/Pos Ref 4	Multi-speed Reference /Position Reference 4	O	O	O	O	O	
6	Forward jog run command	FJOG	ON: Forward operation in jog mode (00-18).	O	O	O	O	O	
7	Reverse jog run command	RJOG	ON: Reverse operation in jog mode (00-18).	O	O	O	O	O	
8	UP frequency increasing command	UP command	ON: Command of output frequency increasing (only used by support of DOWN command).	O	O	O	O	O	
9	DOWN frequency decreasing command	DOWN command	ON: Command of output frequency decreasing (only used by support of UP command).	O	O	O	O	O	
10	Acceleration/deceleration time selection 1	Acc/Decel Time Selection 1	Acceleration/deceleration time selection command1	O	O	O	O	O	
11	Inhibit Acceleration/deceleration Command	ACC/DEC Inhibit	ON: Acceleration/deceleration prohibition	O	O	O	O	O	
12	Retain	Reserved	Retain	-	-	-	-	-	
13	Retain	Reserved	Retain	-	-	-	-	-	
14	Emergency stop (decelerate to zero and stop)	E-Stop	ON: Emergency stop input	O	O	O	O	O	
15	External baseblock command (rotation freely to stop)	Ext. BB	ON: Inverter base interdiction	O	O	O	O	O	
16	PID control disabled	PID Disable	ON: PID control disabled	O	O	O	O	O	
17	Fault reset	Fault Reset	Fault reset	O	O	O	O	O	
18	Retain	Reserved	Retain	-	-	-	-	-	
19	Speed Search 1 (from the maximum frequency)	Speed Search 1	ON: Search the speed from the maximum output frequency	O	X	O	X	O	
20	Manual energy saving function	Energy saving	ON: Manual energy saving control is basedon the settings of 11-12 and 11-18.	O	O	X	X	O	
21	PID integral reset	PID I-Reset	ON: PIDintegral value reset	O	O	O	O	O	
22	Retain	Reserved	Retain	-	-	-	-	-	
23	Retain	Reserved	Retain	-	-	-	-	-	
24	PLC input	PLC Input	ON: Digital PLC input	O	O	O	O	O	
25	External fault	Ext. Fault	ON: External fault alarm	O	O	O	O	O	
26	3-Wire sequence (Forward/Reverse command)	3-Wire (FWD/REV)	3-wire control (forward/reverse command). When the parameter is set to 26, terminal S1 and terminal will become operation command and stop command respectively, and their original functions will be closed.	O	O	O	O	O	

Setting	Function		Description	Control mode					Ref. page
	Name	LCD Display		V/F	V/F + PG	SLV	SV	PM SV	
27	Local/Remote selection	Local/Remote	ON: Local mode (via the digital operator) OFF: Frequency command and operation command will be determined according to the setting of parameter (00-02 and 00-05).	○	○	○	○	○	
28	Remote mode selection	Remote Mode Sel	ON: RS-485 communication OFF: Control circuit terminal	○	○	○	○	○	
29	Jog frequency command	JOG Freq Ref	ON: selection jog frequency command	○	○	○	○	○	
30	Acceleration/deceleration setting command 2	Acc/Decel Time Selection 2	Acceleration/deceleration time selection command2	○	○	○	○	○	
31	Inverter overheating warning	Overheat Alarm	ON: Inverter overheat alarm (OH2) input( will display OH2)	○	○	○	○	○	
32	Sync command	Sync Command	ON: Synchronous speed start OFF: Synchronous speed close (Start other frequency command).	○	○	○	○	○	
33	DC braking	DC Brake Command	ON: Perform DC braking	○	○	○	○	○	
34	Speed Search 2 (from the frequency command)	Speed Search 2	ON: Search speed from set frequency	○	X	○	X	○	
35	Time function input	Time Input	.Set the time function at 03-33, 03-34 .Set the time function output at 03-11, 03-12	○	○	○	○	○	
36	PID Soft start ineffective	PID SFS Disable	ON: PID slow-start off	○	○	○	○	○	
37	Traversing operation	Wobble Run	ON: Frequency wobbling operation	○	○	X	X	○	
38	Upper Deviation of traverse operation	Upper Dev Run	ON: Upper offset of f requecy wobbling	○	○	X	X	○	
39	Lower Deviation of traverse operation	Lower Dev Run	ON: Lower offset of f requecy wobbling	○	○	X	X	○	
40	Switching between motor 1/motor 2	Motor 2 Switch	ON: Start motor 2	○	○	○	○	○	
41	Retain	Reserved	Retain	-	-	-	-	-	
42	PG invalid	PG Invaidd	ON: Speed control without PG	X	○	X	X	○	
43	PG integral reset	I-Time Reset	ON: Integral value reset of speed control with PG	X	○	X	○	○	
44	Mode switching between speed and torque	Speed/Torque change	ON: Torque control mode	X	X	X	○	○	
45	Negative torque command	Reverse Tref	ON: Reverse external torque command	X	X	X	○	○	
46	Zero-servo command	Zero-Servo	ON: Zero-servo operation	X	X	X	○	○	
47	Fire Mode	Fire Mode	ON: Turn off hardware and software fault or alarm protection (a special application of HVAC)	○	○	○	○	○	
48	KEB acceleration	KEB Accel.	ON: KEB acceleration start	○	○	○	○	○	
49	Parameters writing allowable	Write Enabled	ON: all parameters are writable OFF: Except reference frequency (00-05) all parameters are write-protected.	○	○	○	○	○	

Setting	Function		Description	Control mode					Ref. page
	Name	LCD Display		V/F	V/F + PG	SLV	SV	PMSV	
50	Unattended Start Protection (USP)	USP	ON: After power is input, the inverter ignores the operation command OFF: After power is input, the inverter will return the operation status before power is cut off.	○	○	○	○	○	
51	Mode switching between speed and position	Multi Pos. Switch	ON: Switch to position mode OFF: Switch to speed mode	X	X	X	○	○	

- (1). 2-wire type forward operation (setting =00).
- (2). 2-wire type reverse operation (setting=01).  
. Refer to the 2-wire operation mode in Figure 4.3.1.
- (3). Multi-speed/position setting command 1 ( setting =02).
- (4). Multi-speed/position setting command 2 ( setting =03).
- (5). Multi-speed/position setting command 3 ( setting =04).
- (6). Multi-speed/position setting command 4 ( setting =05).

Switch the frequency reference by multi-function digital input.

If it is SV or PMSV mode (00-00=3,4), and 03-00~07is set to 51, you can use multi-speed command to set commands of multiple segment positions.

- (7). Jog frequency selection (setting =29).

Switch the frequency reference by multi-function digital input.

If it is SV or PMSV mode (00-00=3,4), and 03-00~07is set to 51, you can use multi-speed command to set commands of multiple segment positions.

.The following table 4.3.7 shows the corresponding combination.

**Table 4.3.7 Multi-speed operation combination**

Speed	Multi-function digital input (S1 to S8) <sup>4</sup>					Frequency selection
	Jog frequency reference	Multi-speed frequency 4	Multi-speed frequency 3	Multi-speed frequency 2	Multi-speed frequency 1	
1	0	0	0	0	0	Frequency command 1 <sup>1</sup> ( 05-01) or main speed frequency <sup>2</sup>
2	0	0	0	0	1	Auxiliary speed frequency or frequency reference 2 ( 06-01) <sup>3</sup>
3	0	0	0	1	0	Frequency command 3 ( 06-02)
4	0	0	0	1	1	Frequency command 4 ( 06-03)
5	0	0	1	0	0	Frequency command 5 ( 06-04)
6	0	0	1	0	1	Frequency command 6 ( 06-05)
7	0	0	1	1	0	Frequency command 7 ( 06-06)
8	0	0	1	1	1	Frequency command 8 ( 06-07)
9	0	1	0	0	0	Frequency command 9 ( 06-08)
10	0	1	0	0	1	Frequency command 10 ( 06-09)
11	0	1	0	1	0	Frequency command 11( 06-10)
12	0	1	0	1	1	Frequency command 12 ( 06-11)
13	0	1	1	0	0	Frequency command 13 ( 06-12)
14	0	1	1	0	1	Frequency command 14( 06-13)
15	0	1	1	1	0	Frequency command 15 ( 06-14)
16	0	1	1	1	1	Frequency command 16 ( 06-15)
17	1 <sup>1</sup>	—	—	—	—	Jog frequency command(00-18)

0 : OFF, 1 : ON, — : Ignore

\*1. Jog frequency terminal priority is higher than that of multi-speed reference 1 to 4.

\*2. When parameter00-05=0 (frequency reference input = digital operator), multi-speed frequency 1 will be set by 05-01 frequency reference setting1). When parameter 00-05=1 (frequency reference

input=control circuit terminal), multi-speed frequency command 1 is input through analog command terminal AI1 or AI2).

\*3. If you set PID target value, multi-speed operation will be ignored.

### Wiring Example

The following figure 4.3.17 and 4.3.18 show the operation example of 9-speed.

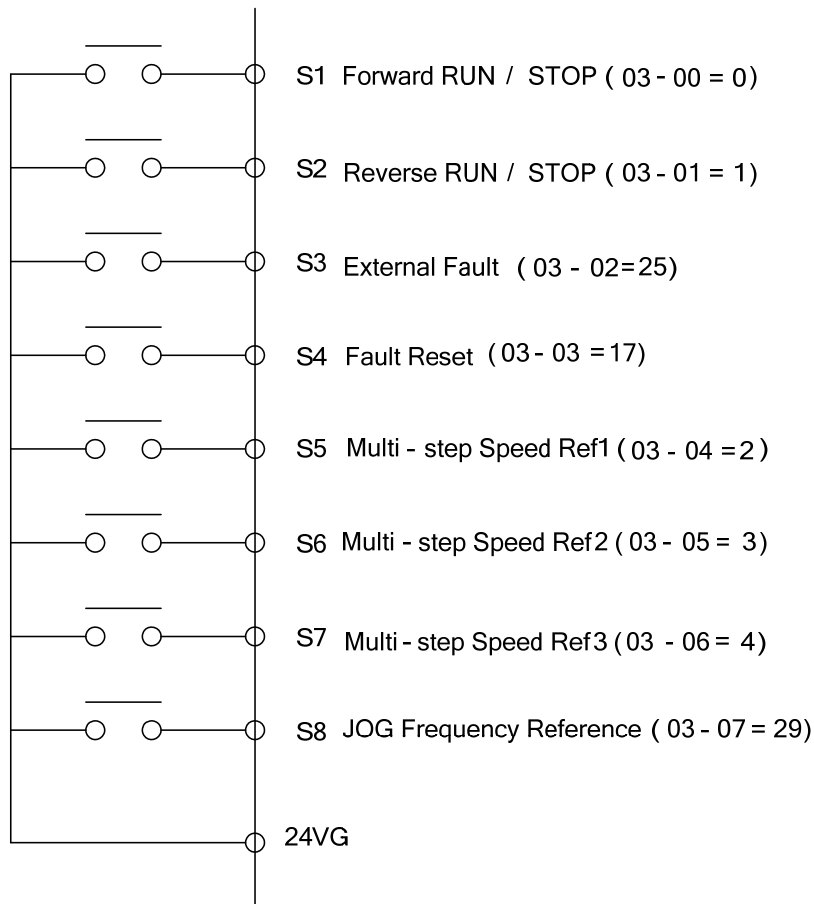

**Figure4.3.17 Control Terminal Wiring Example**



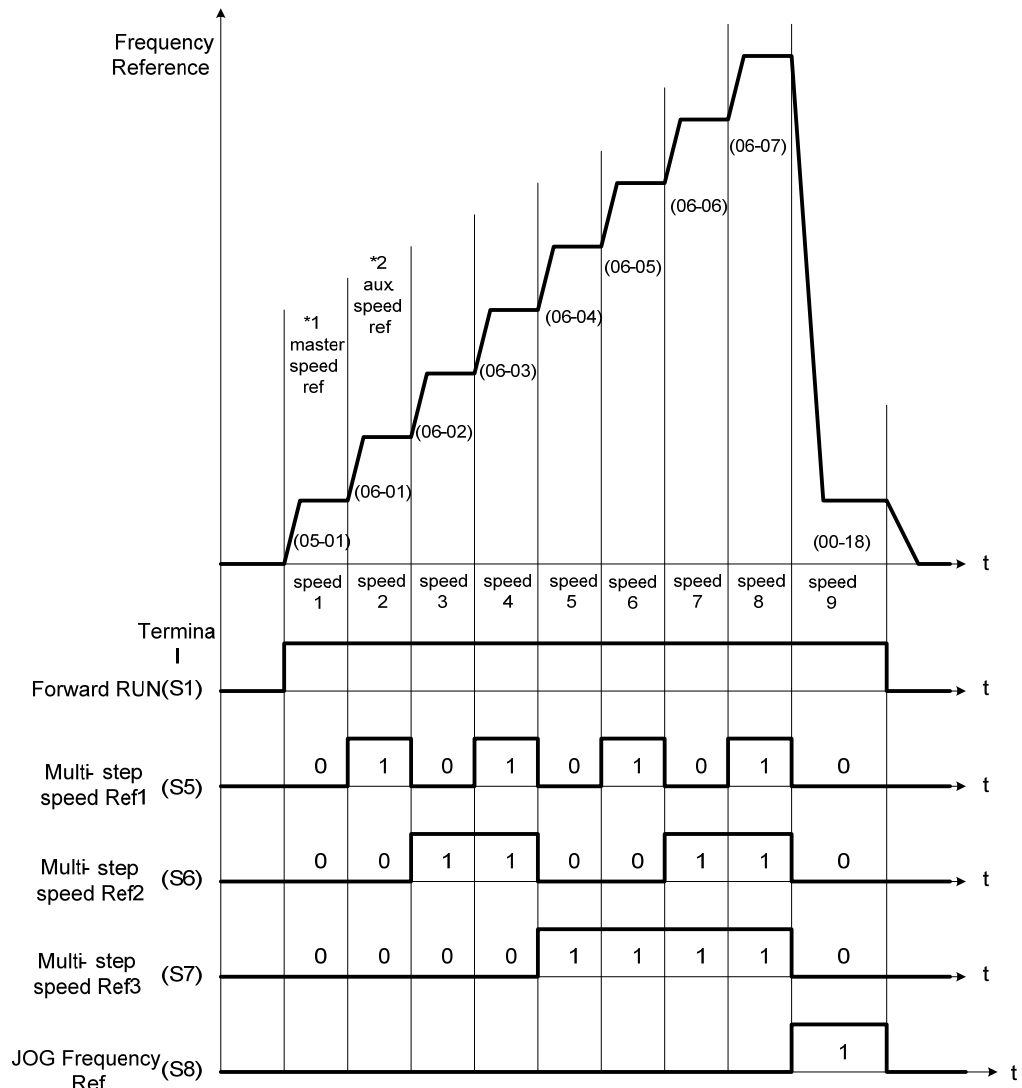

Figure 4.3.18 9-speed time diagram

\*1. When 00-05 = 1, multi-speed frequency reference is input through terminal AI1 or AI2

(8). Forward jog run command (FJOG) (setting=06).

(9). Reverse jog run command (RJOG) (setting =07).

Jog orientation can be set to forward or reversal.

setting=06: FJOG command (ON: Set jog frequency to forward by 00-18)

=07: RJOG command (ON: Set jog frequency to reverse by 00-18).

.The priority of FJOG and RJOG commands is higher than that of other frequency command.

.If FJOG and RJOG commands are started more than 500 ms, set the stop way by 07-09 (Stop way selection) to stop operation.

(10). UP frequency increasing command (setting = 08).

(11). Down frequency decreasing command (setting = 09).

. You can use digital operator (see Parameter11-56) or external multi-function digital input (terminals S1 to S8) to increase or decrease the output frequency of the inverter when the motor is operating.

. When using an external multi-function digital input terminals to perform UP / DOWN operation, set 00-05(Source selection of main frequency command)to 2(Terminal UP /DOWN) and then set any one parameter from 03-00 to 03-07 to 08(UP command) and 09 (DOWN command). You need to use two terminals to

- perform UP or DOWN.
- . Output frequency will be UP or DOWN following the acceleration and deceleration time.

When the following situations occur, it will display an error message of "SE02 DI terminal Error" (SE02):

- (1). Only set a single UP or Down command.
- (2). Start UP / Down command and the acceleration / deceleration prohibition command simultaneously.

.For the examples of UP/DOWN wiring and time, please refer to figure 4.3.19 and figure 4.3.20.

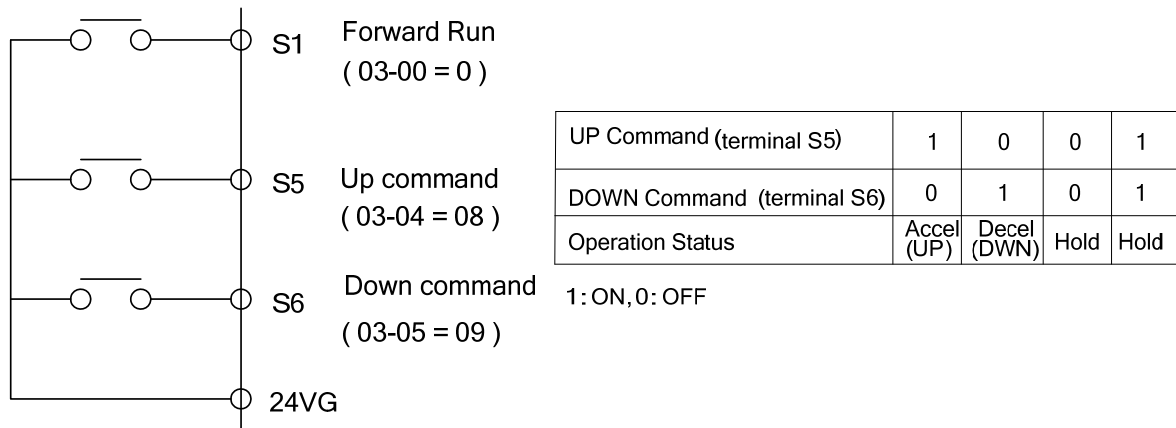

Figure 4.3.19 UP/DOWN wiring example

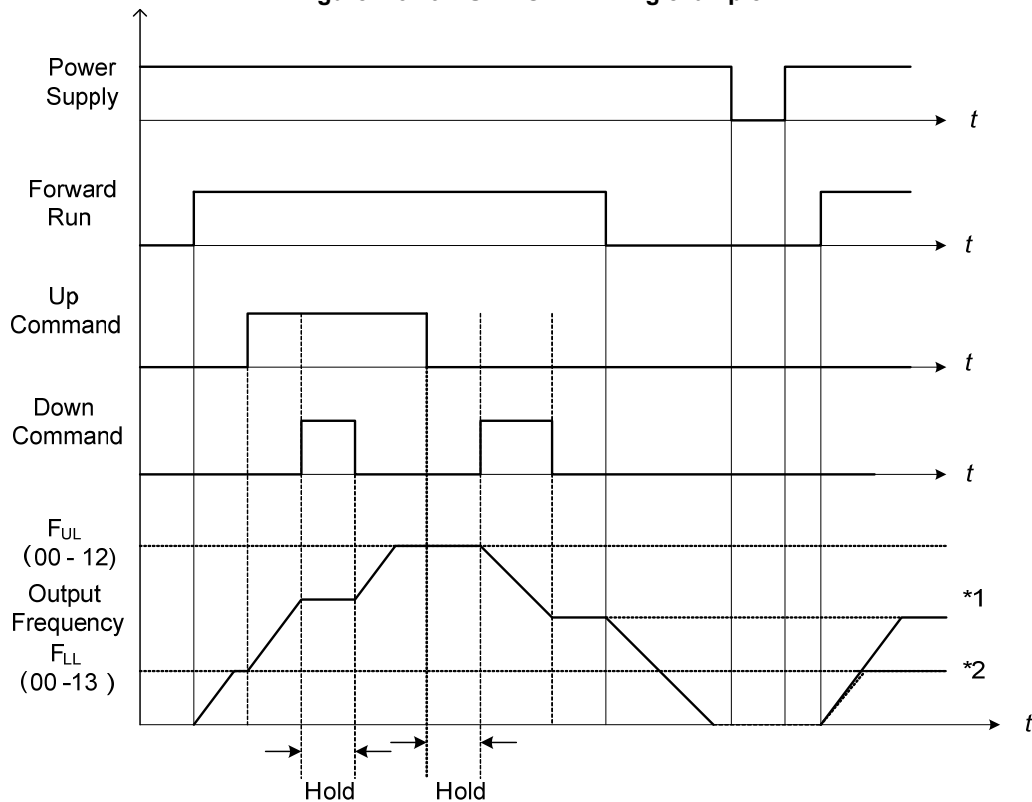

Figure 4.3.20 Up / Down command time diagram

- . When using the UP / Down command, if the operation command is input, the output frequency will accelerate to the lower limit of frequency reference (00-13).
- . When using the UP / Down command, the output frequency is limited by the upper

limit of frequency reference (00-12) and the lower limit of frequency reference (00-13).

- . When 11-58 (reference frequency record function) is set to 1 (reference frequency records), use UP / DOWN command, the frequency command at the moment that the power is cut off can be saved.
- . The acceleration / deceleration time based on this function is the same as normal operation, namely Tacc1 / Tdec1 (00-14,15) or Tacc2 / Tdec 2 (00-16, 17).

- \*1. When 11-58 = 1 and the operation command is input, the output frequency will accelerate to the previously stored frequency command.
- \*2. When 11-58 = 0 and the operation command is input, the output frequency will accelerate to the lower limit of frequency reference (00-13).

(12). Acceleration/deceleration setting command 1 (setting = 10).

(13). Acceleration/deceleration setting command 2 (setting = 30).

Refer to the "multi-function digital input terminals switch acceleration / deceleration time" on the section of page.4-42.

(14). Inhibit Acceleration/deceleration command (setting = 11).

(Inputting from multi-function digital terminals) will suspend the acceleration / deceleration of the motor, and maintain the output frequency. If 11-58 = 1, The output frequency at that moment will be recorded (the output frequency of pause status will be recorded). When the prohibition of acceleration / deceleration command is removed, the acceleration / deceleration function continues to execute.

. If set 11-58 to 1 (record the output frequency of pause status), and input the acceleration / deceleration prohibition command, then the output frequency will be stored even though the power is cut off.

For the operation way of acceleration / deceleration prohibition, please refer to the following Figure 4.3.21.

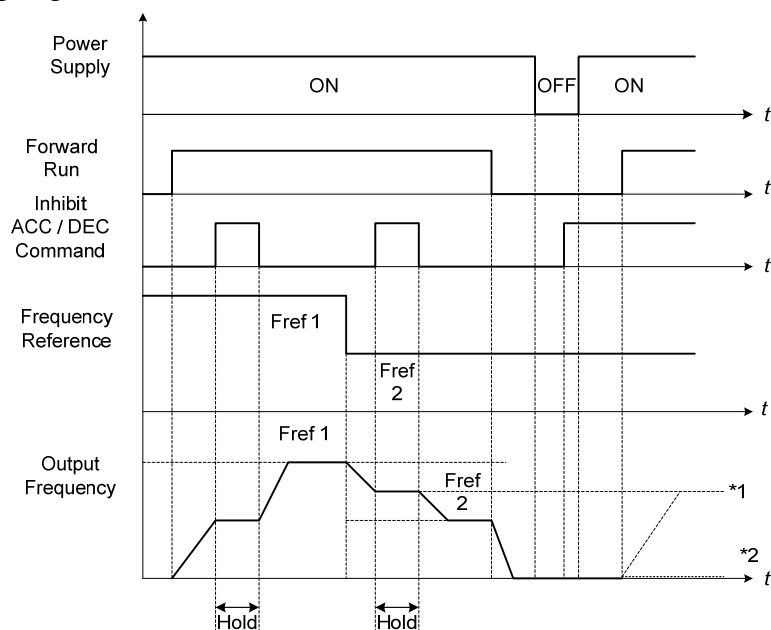

**Figure 4.3.21 operation way of acceleration / deceleration prohibition**

- \*1. When 11-58 = 1, the acceleration / deceleration prohibition command is input, the output frequency will be stored even though the power is cut off. When the operation command is input (for example, forward) and the acceleration / deceleration prohibition command is started, the inverter will continue to accelerate from the previously stored output frequency.

\*2. When 11-58 = 0, and the operation command is input under the condition that the acceleration / deceleration prohibition command is started, the output frequency will be set to zero.

(15). Emergency stop (decelerate to zero and stop) (setting = 14).

Refer to the "deceleration time of emergency stop" of parameter 00-26

(16). External Baseblock Command (rotation freely to stop) (setting = 15).

Execute the base block command by the use of ON / OFF way of multi-function digital input terminal, and prohibit the inverter output.

In operation: When an external base block signal is detected, the digital operator will display "BBn BaseBlock (Sn)". If  $n = 1 - 8$ , it indicates the inverter output is cut off. After the base block signal is removed, the motor will re-operate based on the reference signal. Before the previous base block command is input, perform the speed search from the frequency reference to confirm the current frequency and continue to operate.

In deceleration: When an external base block signal is input, the digital operator will display "BBn", where  $n = 1 - 8$ , it indicates the inverter output is cut off. The motor will generally stop. After the base block signal is removed, the inverter will remain in the stop mode.

In acceleration: the operating way is the same as that of operation period.

When using the base block command, refer to the following time diagram in Figure 4.3.22.

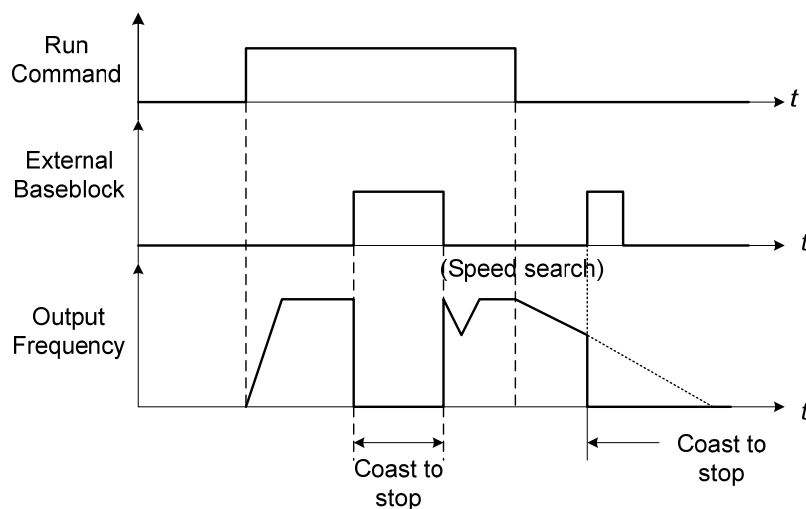

Figure 4.3.22 External base block operation

(17). PID control disable (setting = 16).

(18). Fault reset (setting = 17).

When the inverter detects a fault, the fault output will be started, and the inverter will output the base block. Digital operator displays fault message.

When fault occurs, the following methods can be used to reset the fault:

- Set one of the multi-function digital inputs (03-00 to 03-07) to 17 (reset fault), and start the fault reset signal.
- Press the reset key of the digital operator (RESET).
- Turn off the power and then turn it on.

(19). Speed Search 1 (from the maximum frequency) ( setting = 19).

(20). Speed Search 2 (from the frequency command) ( setting = 34).

Refer to the "speed search" function from pages 4-104 to 4-107.

(21). Manual energy saving function (setting = 20)

Start: the start of manual saving energy function is set by 11-12 and 11-18. For the

- manual energy saving operation, refer to Figure 4.3.88.
- (22). PID integral reset (setting = 21).
  - (23). External fault (setting = 25)
    - . When an external fault occurs, the external fault input terminal is started, the inverter will be turned off and the motor will coast to stop.
    - . If the external input terminal S3 is set (03-02 = 25) to the external fault, it will display the message (EF3) "EF3 Ext. Fault (S3)"
    - . All eight input terminals (S1 to S8) can be designated as the external fault inputs.
  - (24). 3-wire sequence(forward / reverse command) (setting = 26).
    - . Refer to the 3-wire operation mode in Figure 4.3.2.
  - (25). Local / Remote selection (setting = 27).
    - . Users can switch the inverter frequency reference, input operation command either in Local (via the digital operator) or Remote mode (via control circuit terminals or RS485 online). You can use 00-05 (reference frequency) and 00-02 (operation way) to determine the selection of input source.
- . Local / Remote mode can be controlled by one of the multi-function digital input terminals S3 to S8. one of parameters 03-02 to 03-07 is set to 27 (Local / Remote control selection), 03-00 to 03-01, for 3-wire control, S1 & S2 are forced to set to operation & stop input. Please refer to the following table.

Input terminal	Mode	Contents
ON	Local mode	. Execute frequency command and operation command through digital operator. . Indicators of SEQ and REF are off.
OFF	Remote mode	. Execute frequency command and operation command through control terminal or RS-485 communication. It might be achieved via 00-05(frequency command) and 00-02(operation command). . Indicators of SEQ and REF are on.

- . For switching Local/Remotemode, you have to stop the inverter firstly before execute the switch.
- (26). Remote mode selection (setting = 28).
  - . In Remote mode, indicators of SEQ and REF are on, you can use terminals AI1 and AI2 to control the frequency command, and use terminals S1, S2 or communication terminal RS-485 to control the operation command.
  - . By setting control terminals (S1 ~ S8) or communication RS-485, you can set one parameter from 03-02 to 03-07 to 28 (operation selection of remote mode). Refer to Figure 4.3.23.

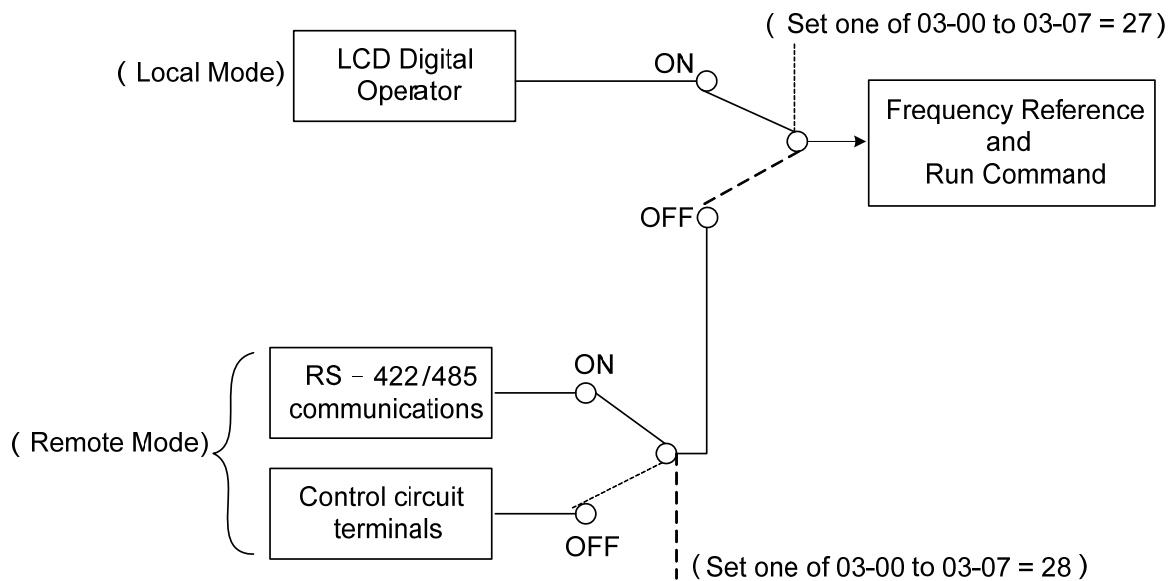

**Figure 4.3.23 Operation selection of remote mode**

. If you switch the frequency reference and operation command input between communication RS-485 and control terminals, please set the following parameters:

- a. 00-05=1 (control terminal AI1 or AI2 as a reference frequency)
- b. 00-02=1 (control terminal S1 or S2 as an operation command)
- c. set from 03-02 to 03-07 (Set 03-02 to 03-07 (one of multi-function digital input terminals S1 to S8 is set to 28 (Operation selection of remote mode)).

(27). Inverter overheating warning (setting = 31).

. When the inverter detects a overheat signal, the digital operator will display a warning message of "OH2", but the inverter goes on operating. When the inverter overheating warning is removed, the digital operator will automatically resume to the original display. You do not need to press the RESET key.

(28). Sync command (setting = 32)

This function is for switching the serial pulse input and the frequency reference converted from other frequency reference (based on 00-05 setting).

When you select Local / Remote mode control selection (setting is 25) or the Remote mode (setting is 26), and the corresponding input is opened, this function is invalid.

. Only in the stop status of the inverter, you can set/clear sync command.

. For the sync operation, refer to page. 4-79.

(29). DC braking (setting = 33).

When stopping the inverter, you can use this setting to execute DC braking function through the set terminals.

If you input the operation command or jog command, DC braking operation will be cleared and the motor will start running.

Refer to the DC braking time diagram in the following Figure 4.3.24.

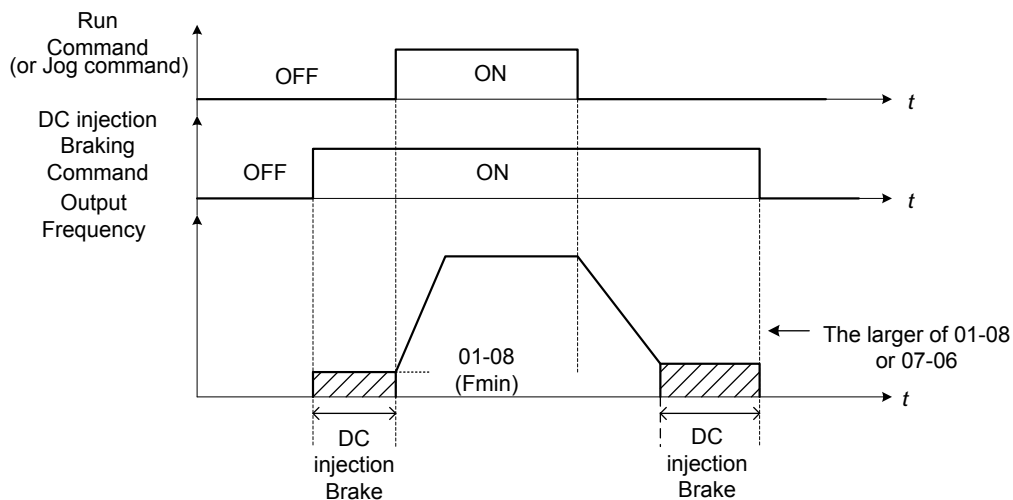

**Figure 4.3.24 DC braking time diagram**

- (30). Timing function input (setting = 35).  
Refer to the "time function" of parameter 03-37 & 03-38.
- (31). PID Soft start invalid (setting =36)  
Refer to the "PID Control" function of PID function group in parameter10.
- (32). Traversing operation (setting =37)
- (33). Upper Deviation of traverse operation (setting =38)
- (34). Lower Deviation of traverse operation (setting =39)  
See "Wobble Frequency" function in parameter19
- (35). Switching between motor 1/motor 2 (setting =40)
- (37). PG invalid (setting = 42).  
It is used to cancel / start the speed control. When the multi-function digital input is started, close the speed control (normally V / f control).
- (38). PG integral reset (setting = 43).  
It is used to switch the proportion control (P) and proportional - integral (PI) control for the speed control.  
When the multi-function digital input is started, use the proportion (P) control (integral reset).
- (39). Mode switching between speed and torque (setting = 44).  
It is used to switch the speed control and torque control for the SV (sensor vector) control mode.  
It acts as torque control when starting, and as speed control when closing. For more details, please refer to Parameter21-torque control group.
- (40). Negative torque command (setting = 45)  
Start: external torque reference command reversal.  
For more details, please refer to Figure 4.3.128.
- (41). Zero-servo Command (setting = 46).  
Start: zero-servo operation.  
Please refer to Figure 4.3.129.
- (42). Fire mode (setting = 47).  
Start: Relieve the fault or warning protection of hardware and software.  
Mainly used for special applications such as exhaust fan and so on
- (43). KEB acceleration (setting = 48).  
Start KEB acceleration DC command (when 11-47 is not zero).  
Pleaser refer to the parameter description of 11-47 and 11-48

(44). Parameters writing allowable (setting = 49).

Please refer to the description of 13-06. If one parameter from 03-00 to 03-07 is set to 49 (Parameter written-protection), when the corresponding control terminal is turned on, the parameter can be stored by the digital operator; in opposite, it is written-protection.

(45) Unattended Start Protection (USP) (setting = 50)

If the operation command has been pre-set (controlled by terminals) and the power is supplied, the inverter starts to operate. The direct operation protection (USP) function after power is supplied (any one parameter from 03-00 to 03-07 is set to 50) can prevent the automatic start. Therefore, the inverter will not automatically start to operate because of external signals. Refer to the following figure.

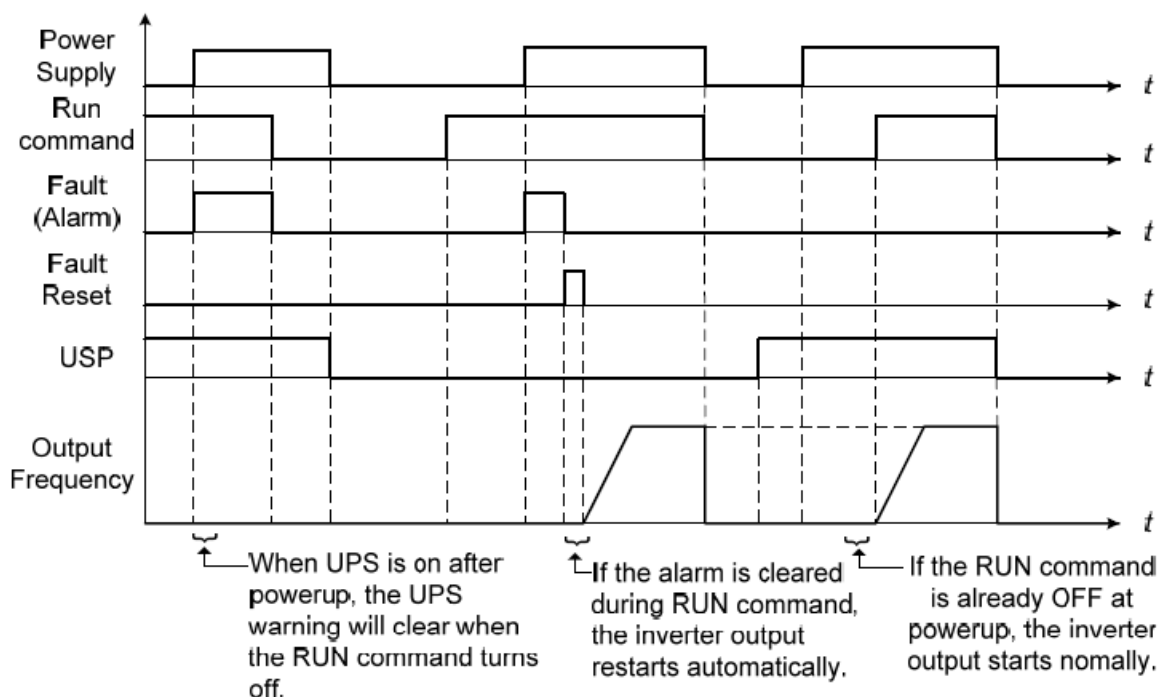

(46). Mode switching between speed and position (setting = 51)

Please refer to the parameter description of 21-09~21-41



<b>03- 08</b>	(S1~S8)DI scan time
<b>Range</b>	<b>【0】</b> scan time 4ms <b>【1】</b> scan time 8ms

- When the CPU chip of the inverter scans terminal TM2, if there are the same signals input by N consecutive times (namely, the number of scan), then the inverter will consider it as normal execution signal; if the number is less than N, then the inverter will consider it as noise.
- A scan time is 4ms.
- Users can determine the interval time of scan based on the impact degree from the noise of environment. When the noise is severe, tune 03—08 to 1, but this tuning will lead to slower response speed.

<b>03- 09</b>	Multi-function terminal S1-S4 type selection
<b>Range</b>	<b>【xxx0b】</b> : S1 A contact <b>【xxx1b】</b> : S1 B contact <b>【xx0xb】</b> : S2 A contact <b>【xx1xb】</b> : S2 B contact <b>【x0xxb】</b> : S3 A contact <b>【x1xxb】</b> : S3 B contact <b>【0xxxb】</b> : S4 A contact <b>【1xxxb】</b> : S4 B contact

<b>03- 10</b>	Multi-function terminal S5-S8 type selection
<b>Range</b>	<b>【xxx0b】</b> : S5 A contact <b>【xxx1b】</b> : S5 B contact <b>【xx0xb】</b> : S6 A contact <b>【xx1xb】</b> : S6 B contact <b>【x0xxb】</b> : S7 A contact <b>【x1xxb】</b> : S7 B contact <b>【0xxxb】</b> : S8 A contact <b>【1xxxb】</b> : S8 B contact

- When general terminals are used, they shall be connected to switch. The switch has different type, for example, the normally open switch and the normally close switch. You have to pay attention to this when selecting the switch for application, because the work status of these two types of switch is different. This parameter determines the requirement of the normally open switch or the normally close switch.

Each bit of 03-09/03-10 presents as below:

03-09= 0 0 0 0    0: normally open switch  
          s4 s3 s2 s1    1: normally close switch  
03-10= 0 0 0 0    0: normally open switch  
          s8 s7 s6 s5    1: normally close switch

The switch input type is selected by users.

Example : if you want S1 and S2 to be connected to the normally close switch, then you can set 03- 09=0011.

Note: Before setting terminals to connect the normally open/normally close switch, do not set the operation command to the control from external terminals, otherwise it will cause unnecessary harm.

03-11	Relay (R1A-R1C) output
03-12	Relay (R2A-R2C) output
Range	<ul style="list-style-type: none"> <li>【0】 : During Running</li> <li>【1】 : Fault contact output</li> <li>【2】 : Frequency Agree</li> <li>【3】 : Setting Frequency Agree (03-13 ± 03-14)</li> <li>【4】 : Frequency detection 1 (&gt; 03-13)</li> <li>【5】 : Frequency detection 2 (&lt; 03-13)</li> <li>【6】 : Automatic restart</li> <li>【7】 : Retain</li> <li>【8】 : Retain</li> <li>【9】 : Baseblock</li> <li>【10】 : Retain</li> <li>【11】 : Retain</li> <li>【12】 : Over torqued detected</li> <li>【13】 : Retain</li> <li>【14】 : Retain</li> <li>【15】 : Retain</li> <li>【16】 : Retain</li> <li>【17】 : Retain</li> <li>【18】 : PLC status</li> <li>【19】 : PLC control contact</li> <li>【20】 : zero speed</li> <li>【21】 : Inverter Ready</li> <li>【22】 : Undervoltage Detected</li> <li>【23】 : Source of operation command</li> <li>【24】 : Source of frequency command</li> <li>【25】 : Low torque detected</li> <li>【26】 : Frequency reference missing</li> <li>【27】 : Time function output</li> <li>【28】 : Traverse operation UP status</li> <li>【29】 : During Traverse operation status</li> <li>【30】 : Motor 2 selection</li> <li>【31】 : Zero servo completed</li> <li>【32】 : Communication control contacts</li> </ul>

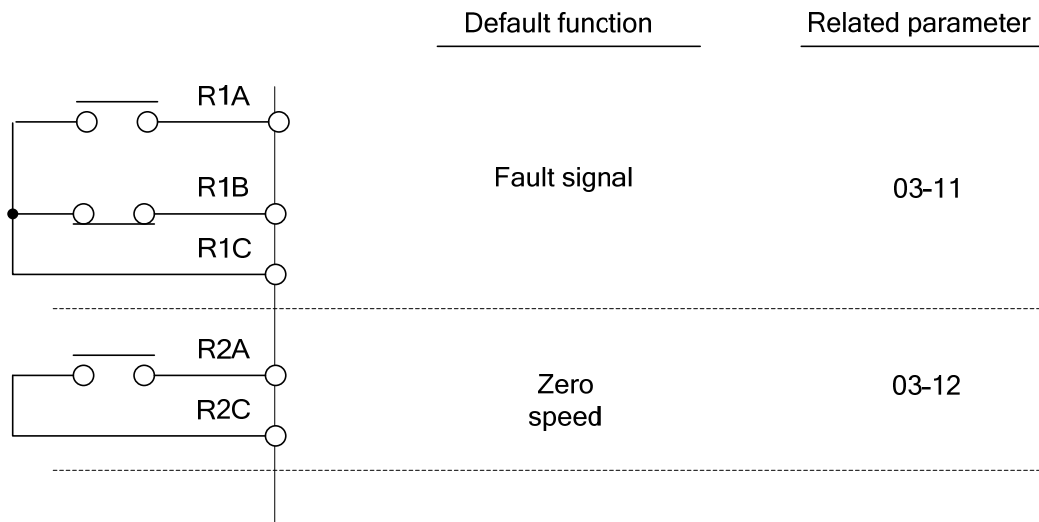

**Figure 4.3.25 Multi-function digital output and related parameters**

**Table 4.3.8 Function table of multi-function digital output**

Setting	Function		Contents	Control way					Ref. page
	Name	LCD display		V/F	V/F + PG	SLV	SV	PM SV	
0	IDuring Running	Running	ON: During running (Run Command is ON)	0	0	0	0	0	
1	Fault contact output	Fault	ON: Fault contact output (except CF00 and CF01 )	0	0	0	0	0	
2	Frequency agree	Freq. Agree	ON: frequency agree (frequency agree width detection is set by 03-14 )	0	0	0	0	0	
3	Setting frequency agree	Setting Freq Agree	ON: Output frequency = allowed frequency detection level (03-13)±allowed frequency width(03-14)	0	0	0	0	0	
4	Frequency detection 1 (> 03-13)	Freq. Detect 1	ON: In acceleration : Output frequency >= 03-13 + 03-14 OFF: In deceleration , Output frequency < 03-13	0	0	0	0	0	
5	Frequency detection 2 (< 03-13)	Freq. Detect 2	OFF: In acceleration : Output frequency >= 03-13 + 03-14 ON: In deceleration , Output frequency < 03-13	0	0	0	0	0	
6	Automatic restart	Auto Restart	ON: the period of automatic restart	0	0	0	0	0	
7	Retain	Invalid Do Func.	Retain	-	-	-	-	-	
8	Retain	Invalid Do Func.	Retain	-	-	-	-	-	
9	Baseblock	Baseblock	ON: During baseblock	0	0	0	0	0	
10	Retain	Invalid Do Func.	Retain	-	-	-	-	-	
11	Retain	Invalid Do Func.	Retain	-	-	-	-	-	
12	Over torque detected	Over Torque	ON: Over torque detection is ON	0	0	0	0	0	
13	Retain	Invalid Do Func.	Retain	-	-	-	-	-	
14	Retain	Invalid Do Func.	Retain	-	-	-	-	-	
15	Retain	Invalid Do Func.	Retain	-	-	-	-	-	
16	Retain	Invalid Do Func.	Retain	-	-	-	-	-	
17	Retain	Invalid Do Func.	Retain	-	-	-	-	-	
18	PLC status	PLC statement	ON: when 00-02 is set to 3 (PLC operation command source)	-	-	-	-	-	
19	PLC control contact	Control From PLC	ON: Control from PLC	-	-	-	-	-	
20	Zero speed	Zero Speed	ON: Output frequency < Minimum output frequency (Fmin)	0	0	0	0	0	
21	Inverter Ready	Ready	ON: Inverter ready (after power on, no faults)	0	0	0	0	0	
22	Undervoltage Detection	Low Volt Detected	ON: DC bus voltage = < Low-voltage warning detection level (07-13)	0	0	0	0	0	

23	Source of operation command	Run Cmd Status	ON: operation command from LED digital operator (local mode)	○	○	○	○	○	
24	Source of reference command	Freq Ref Status	ON: reference frequency from LED digital operator (local mode)	○	○	○	○	○	
25	Low torque detected	Under Torque	ON: Low-torque detection is ON	○	○	○	○	○	
26	Frequency reference missing	Ref. Loss.	ON: Reference frequency loss	○	○	○	○	○	
27	Timing function output	Time Output	Set time function parameter to 03-33 and 03-34, and the time function input is set by parameter from 03-00 and 03-07	○	○	○	○	○	
28	Traverse operation Status UP	Traverse UP	ON: in acceleration period (when the wobbling is in operating )	○	○	X	X	○	
29	During Traverse operation status	During Traverse	ON: In the period of frequency wobbling operation (when the wobbling is in operating )	○	○	X	X	○	
30	Select motor 2	Motor 2 Selection	ON: Switch to motor 2	○	○	○	○	○	
31	zero servo completed	Zero Servo	ON: Zero servo function is completed	X	X	X	○	○	
32	Communication control contacts	Control From Comm	ON: DO is set by communication control.	○	○	○	○	○	

(1). During Running (setting = 0)

OFF	Operation command is OFF and the inverter is in closed status.
ON	Operation command is ON, or the operation command is OFF but there is residual output.

(2). Fault contact output (setting = 1)

. When fault occurs, the output contact is ON. If the digital operator encounters communication error (CF00 or CF01), then it will not operate.

(3). Frequency Agree (setting = 2).

(4). Setting Frequency Agree (setting =3).

(5). Frequency detected 1(setting =4).

(6). Frequency detected 2(setting =5).

. Please refer to the group parameter 03 for the frequency detection.

(7). Automatic restart (setting =6).

. In the auto-restart operation, the output contact is ON.

(8). Baseblock (B.B.) (setting =9).

. The inverter output is baseblocked.

(9). Over torque detected (NO contact )(setting =12).

(10). Low torque detected (No contact )(setting =25).

. Set any one parameter of 03-11, 03-12 to 12 or 25, the multi-function digital output terminals can be used to output detection signal of over torque / less torque.

(11).PLC status (setting =18).

. Set the operation command source of 00-02 to 3(PLC control), it is a status of ON.

(12).PLC control contact (setting =19).

. Under the PLC control mode, the inverter control command source is a status of ON.

(13).Zero-speed (setting =20).

OFF	Output frequency => minimum output frequency (01-08, Fmin)
ON	Output frequency is <the minimum output frequency

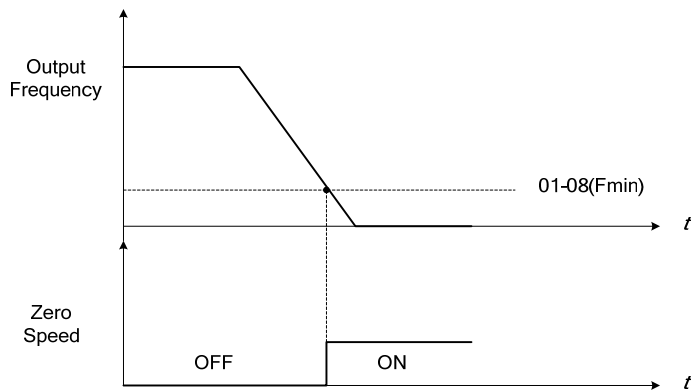

**Figure 4.3.26 Zero-speed operation**

(14). Inverter Ready (setting =21).

. Inverter operation ready after power on and no faults have occurred.

(15). Undervoltage Detection (setting =22).

. ON = the DC bus voltage of the main circuit is lower than the less voltage detection level (07-13).

(16). Source of operation command (setting =23).

OFF	Remote mode: When 00-02 = 1 or 2, or set any one of multi-function digital output terminals (S1 to S8) to LOCAL / REMOTE control (setting value = 5), the contact is OFF and the SEQ indicator of the digital operator is on.
ON	Local mode: When 00-02 = 0, or set any one of multi-function digital output terminals (S1 to S8) to LOCAL / REMOTE control (setting value = 5), the contact is ON and the SEQ indicator of the digital operator is off.

(17). Source of frequency command (setting =24).

OFF	Remote mode: When 00-05 = 1 or 2, or set any one of multi-function digital output terminals (S1 to S8) to LOCAL / REMOTE control (setting value = 5), the contact is OFF and the REF indicator of the digital operator is on.
ON	Local mode: When 00-05 = 0, or set any one of multi-function digital output terminals (S1 to S8) to LOCAL / REMOTE control (setting value = 5), the contact is ON and the REF indicator of the digital operator is off.

(18). Frequency reference missing (setting =26).

. when the operation command is ON and the frequency reference is 0, and when 11-41 is set to 1 (operation based on 11-42 multiplies the previous frequency reference value), the output contact is a status of ON.

(19). Time function output (setting =27).

. For the time function operation, please refer to the descriptions of parameter 03-37 and 03-38.

(20). Traverse operation UP status (setting =28).

. For frequency wobbling operation, please refer to Parameter 19-Frequency function group

(21). During Traverse operation status (setting =29).

. By setting 28 or 29, the acceleration period or frequency wobbling operation can be output to the function digital output terminals. For frequency wobbling control, please refer to Parameter 19 -Frequency function group.

(22). motor 2 selected (setting =30).

(23). Zero Servo Completed (setting =31).

.In zero servo status, it is ON.

(24). Communication control contacts (setting =32).

<b>03-13</b>	Frequency detection Level
<b>Set Range</b>	<b>【0.0~400.0】 Hz</b> <b>【0.0~1200.0】 Hz</b> (when 00-31 = 1 )
<b>03-14</b>	Frequency detection width
<b>Range</b>	<b>【0.1~25.5】 Hz</b>

- . Frequency detection Level: set the multi-function output terminals R1A-R1C, R2A-R2C or PH1 (03-11, 03-12 or 03-28) to output the desired frequency agree signal, setting frequency agree and output frequency detection 1 and 2.
- . The time charts for the Frequency Agree Detection operation are shown in the following table 4.3.9.

**Table 4.3.9 Frequency detection operation**

Function	Detection operation of frequency confirmation	Description
Frequency agree		<ul style="list-style-type: none"> <li>. When the output frequency is in the range of frequency reference±frequency detection width (03-14), the frequency confirmation output signal is ON.</li> <li>. Set any one parameter of 03-11,03-12 or 03-28 to 2 (frequency agree)</li> </ul>
Set frequency agree		<ul style="list-style-type: none"> <li>. In acceleration, when the output frequency reaches frequency agree detection level (03-13) and in the range of frequency confirmation detection width (03-14), the set frequency agree signal is ON.</li> <li>. Set any one parameter of 03-11,03-12 or 03-28 to 3 (set the frequency agree)</li> </ul>
Output frequency detection 1		<ul style="list-style-type: none"> <li>. In acceleration, if the output frequency is greater than the frequency detection level (03-13) + the frequency detection width (03-14), the signal of output frequency detection 1 is ON.</li> <li>. In deceleration, if the output frequency is less than the frequency detection level (03-13), the signal of output frequency detection 1 is OFF.</li> <li>. Set any one parameter of 03-11,03-12 or 03-28 to 4 (output frequency detection 1)</li> </ul>
Output frequency detection 2		<ul style="list-style-type: none"> <li>. In acceleration, if the output frequency is greater than the frequency detection level (03-13) + the frequency detection width (03-14), the signal of output frequency detection 1 is OFF.</li> <li>. In deceleration, if the output frequency is less than the frequency detection level (03-13), the signal of output frequency detection 1 is ON.</li> <li>. Set any one parameter of 03-11,03-12 or 03-28 to 5 (output frequency detection 2)</li> </ul>

<b>03- 19</b>	Relay (R1A-R2C) type
<b>Range</b>	<b>【xxx0b】</b> : R1 A contact <b>【xxx1b】</b> : R1 B contact <b>【xx0xb】</b> : R2 A contact <b>【xx1xb】</b> : R2 B contact

<b>03- 27</b>	UP / DOWN frequency maintaining selection
<b>Range</b>	<b>【0】</b> : Maintain UP/DOWN frequency when stopping. <b>【1】</b> : Clear UP/DOWN frequency when stopping. <b>【2】</b> : Allow frequency UP/DOWN when stopping.

03-27 is set to 0, when run command is removed, the frequency command before deceleration will be maintained and will not be removed. The next run command will output according to the previous recorded frequency.

03-27 is set to 1, when run command is removed, the frequency command before deceleration will be cleared.

03-27 is set to 2, without run command, its UP/DOWN command effectively writes the frequency command.

<b>03- 28</b>	Optocoupler output
<b>Range</b>	Range and definition are the same as those of 03-11, 03-12
<b>03-29</b>	Optocoupler output selection
<b>Range</b>	<b>【xxx0b】</b> : Optocoupler A contact <b>【xxx1b】</b> : Optocoupler B contact

<b>03- 30</b>	Function setting of pulse input
<b>Range</b>	<b>【0】</b> : Frequency command <b>【1】</b> : PID feedback <b>【2】</b> : PID target value <b>【3】</b> : Retain
<b>03-31</b>	Scale of pulse input
<b>Range</b>	<b>【50~32000】</b> Hz
<b>03- 32</b>	Gain of pulse input
<b>Range</b>	<b>【0.0~1000.0】</b> %
<b>03-33</b>	Bias voltage of pulse input
<b>Range</b>	<b>【-100.0~100.0】</b> %
<b>03-34</b>	Filter time of pulse input
<b>Range</b>	<b>【0.00~2.00】</b> Sec

\* Refer to Table 2 in Chapter 3 for the pulse input specification.

.Figure 4.3.27 shows the schematic of using pulse input function for adjustment

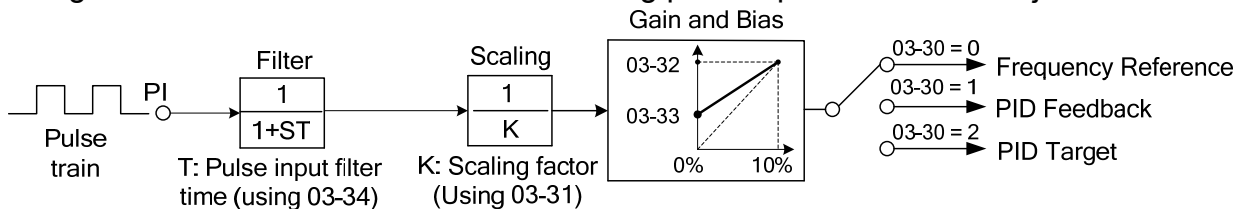

**Figure 4.3.27 Pulse input adjustment**

- (1). Set 00-05 (frequency reference selection) to 4 (serial pulse input), take the serial pulse input terminal PI as a frequency reference. For using pulse input as reference frequency, please refer to Figure 4.3.5.
- By setting 03-30 (pulse input) to 0 (frequency reference), select the serial pulse input terminal PI as a function of frequency reference, and then set the number of pulse by the parameter 03-31 (pulse input scale) equaling to maximum output frequency (01-02). If there is interference affecting performance, you can increase the value of 03-34 (filter time of pulse input).
  - When setting 03-30 to 0 (PID feedback value), you need to set 10-00 = 3 or 4, otherwise it might appear the error of SE09 "PI setting error".
- (2). PID input of pulse input (03-30 = 1 or 2)
- Use parameter 10-03 (PID control mode) to perform PID control, and set the PID feedback value and target value.
  - When setting 03-30 to 1 (PID feedback value), the pulse serial input to the control terminal PI is regarded as the PID feedback value. When setting 03-30 to 2 (PID target value), the pulse serial input to the control terminal PI is regarded as the PID target value. Please refer to Figure 4.3.28.

When setting 03-30 to 1 (PID feedback value), you need to set 10-01 = 3, otherwise it might appear the error of SE09 "PI setting error".

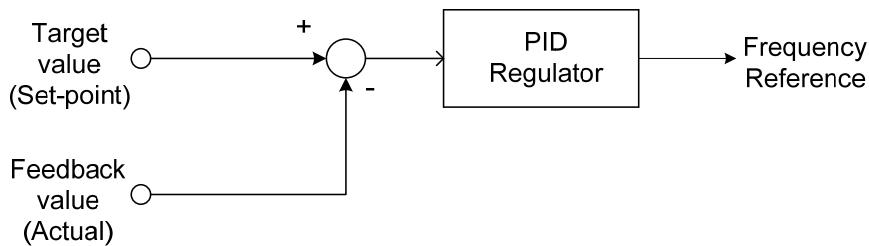

Figure 4.3.28 PID control

<b>03-35</b>	Function setting of pulse output
<b>Range</b>	<b>【1】</b> : Frequency command <b>【2】</b> : Output frequency <b>【3】</b> : Output frequency after the soft start <b>【4】</b> : motor speed <b>【5】</b> : PID feedback <b>【6】</b> : PID input <b>【7】</b> : PG output
<b>03-36</b>	Scale of pulse output
<b>Range</b>	<b>【1~32000】 Hz</b>

- (1). Pulse output function selection (03-35)
- For the pulse output function selection, refer to Table 4.3.10.



**Table 4.3.10 Pulse output function selection**

03-35 Setting	Function	Screen display (LCM)		Remark
1	Frequency command	Freq Ref	12-16	100% = Maximum output frequency (01-02)
2	Output frequency (Fout)	Output Freq	12-17	100% = Maximum output frequency (01-02)
3	Output frequency after soft-start	Output Freq (SFS)	-	100% = Maximum output frequency (01-02)
4	motor speed (rpm)	Motor Speed	12-22	100% = Maximum output frequency (01-02)
5	PID feedback	PID Feedback	12-39	100% = Maximum output frequency (01-02)
6	PID input	PID Input	12-36	100% = Maximum output frequency (01-02)
7	PG output	PG Pulse Output		

.items 1~4 are related to the speed, 5 and 6 are related to PID, 7 is related to PG.

(2). Adjust the pulse output scale (03-36).

. Use 03-36 (pulse output scale) to adjust the PO to set the pulse output number to 100% of the corresponding selected item. Please refer to the figure 4.3.29.

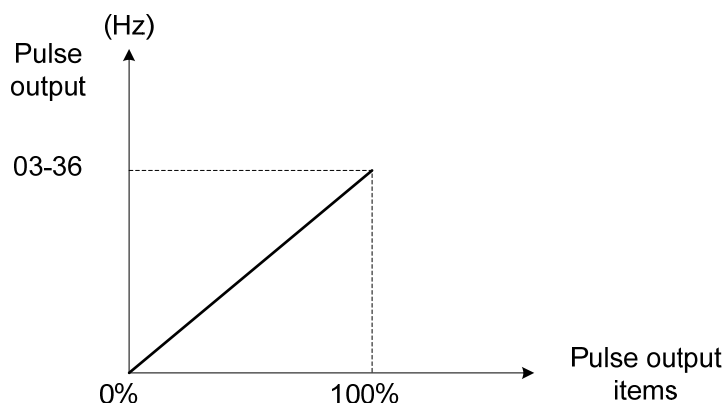

**Figure 4.3.29 Pulse output proportion**

. When setting 03-35 to 2 (output frequency) and setting 03-36 to 0 (0 Hz), PO's pulse output and the inverter output frequency are sync.

. For the pulse output signal level, please refer to the following figure 4.3.30.

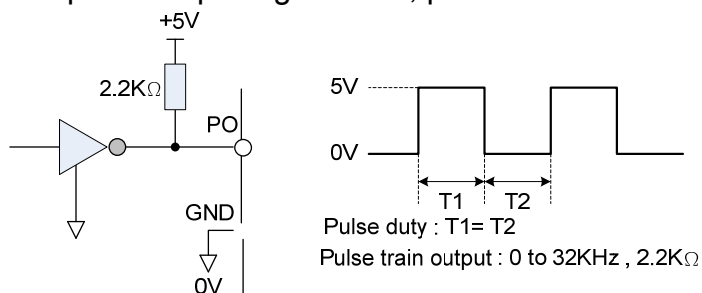

**Figure 4.3.30 Pulse output signal level**

. When 03-35 = 7 (PG pulse monitoring output), PG pulse output proportion is 1:1, ignore the 03-36 settings.

(3). Application examples

Example A PG connection operation

. Use the directly input serial pulse signal as the frequency reference, the operation (or synchronization operation) can be referred to the following Figure 4.3.31.

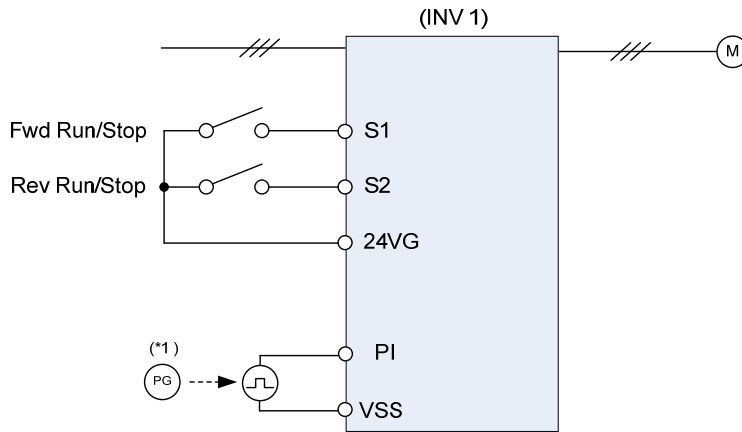

Figure 4.3.31 PG connection operation

.Related parameter settings:

1. Frequency reference selection: 00-05=4 (Pulse input) .
2. Pulse input's function selection: 03-30=0 (Frequency command) .
3. Pulse input scale: 03-31 (set the number of pulse in Hz to equal to the maximum output frequency, 01-02)
4. Pulse input gain: 03-32 (Set the input gain of the pulse frequency set by 03-31)
5. Pulse input bias: 03-33 (Set the input bias of the pulse frequency set by 03-31)
6. Pulse input's filter time: 03-34 (if the pulse input is instable due to the interference, please increase the set value.)

. Use the forward and reverse commands of multi-function digital input to change the rotation orientation.

. If high accuracy is required, you can apply the SV or V / f + PG control mode.

Example B: The connection operation of 2 inverters

. As to use two inverters for "tracking" or synchronization operation, please refer to Figure 4.3.32.

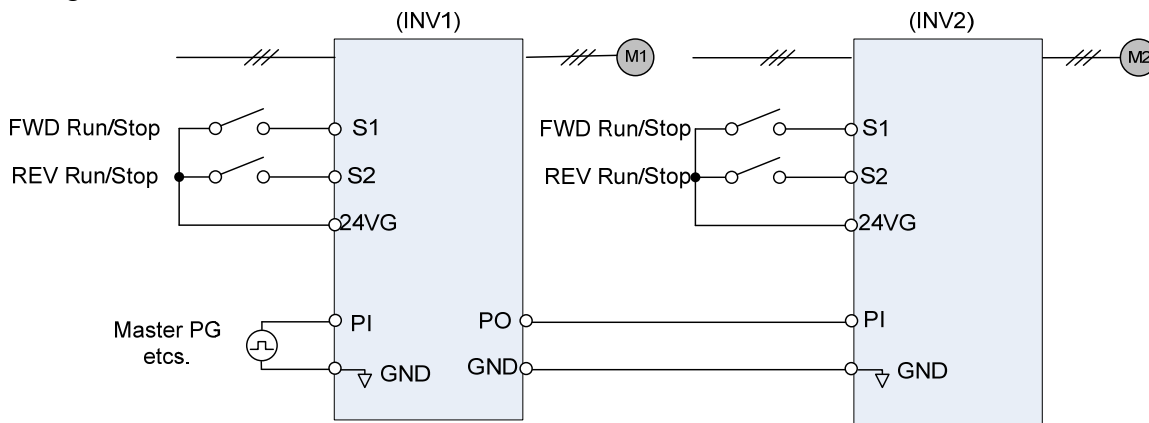

Figure 4.3.32 The connection operation of 2 inverters

.INV 1's related parameter setting:

1. Frequency reference input::

Case 1: Set the parameter associated with the pulse input to the same as the previous example, so as to use pulse input (for example, the master PG, etc.) to run INV 1.

Case 2: Use 00-05 to select the main frequency reference so as to use the analog frequency reference to run INV 1.

2. Frequency reference pulse output:

a. Pulse output function selection: 03-35=1 (the output frequency reference from the pulse output terminal PO).

b. Pulse output scale : 03-36 (when the operation is in full speed, set the number of

output pulse)

. INV 2's related parameter setting:

1. Frequency reference input: 00-05=4 (Pulse input)。
2. Function selection of pulse input: 03-30=0 (Frequency command)。
3. Pulse input scale: 03-31 (set the number of pulse in Hz to equal to the maximum output frequency, 01-02, generally set this value to the same value as 03-31 of INV 1) 。
4. Pulse input gain: 03-32 (Set the input gain of the pulse frequency set by 03-31. when INV2 is geometric proportion, please adjust 03-32) 。
5. Pulse input bias: 03-33 (Set the input bias of the pulse frequency set by 03-31. When the bias setting of INV 2 has been set, please adjust 03-33) 。
6. Pulse input's filter time: 03-34(if the pulse input is instable due to the interference, please increase the set value.)

Example C: The synchronized operation of using pulse input

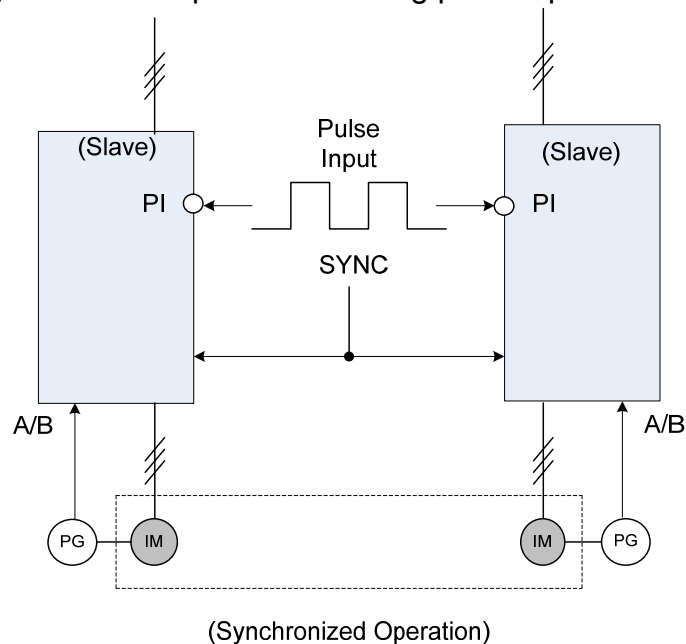

Figure 4.3.33 The synchronized operation of using pulse input

- . Apply the pulse signals of external pulse generator to the pulse input terminal PI of multiple inverters for synchronization.
- . Set 00-05 to 4 (pulse input frequency command), and set 03-30 to 0 (pulse input terminal function as frequency command).
- . By setting the corresponding parameter (03-00 to 03-07) to 32, specify any one of the multi-function digital input terminals (S1 to S8) for synchronization command.
- . Change the serial pulse received from pulse input (terminal PI) into a synchronized frequency command so that the synchronization command (SYNC) ensures the frequency reference can be executed. For the synchronization operation of using pulse input, please refer to Figure 4.3.33.

Example D. The synchronized operation of using pulse output.

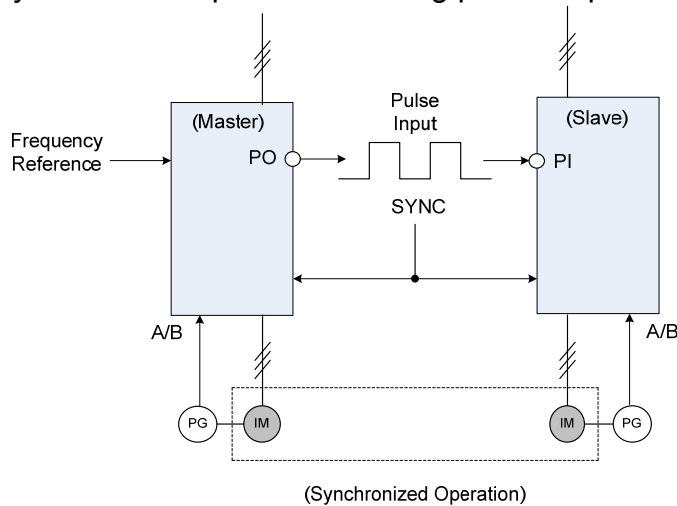

Figure 4.3.34 The synchronized operation of using pulse output

- . Set 03-35 to 1 (pulse output function as frequency command). The frequency reference of the inverter inner will be changed into pulse output signal (terminal PO).
- . Set 00-05 to 4 (pulse input frequency command), and set 03-30 to 0 (pulse input terminal function as frequency command). Use 03-31 to 03-33 from the inverter, orderly adjust the proportion, gain and bias.
- . The pulse output signal converted by the master inverter can be input to the pulse input terminal of the client inverter, so that the master inverter and the client inverter can be synchronized.
- . For the synchronization operation of using pulse output, please refer to Figure 4.3.34.

<b>03- 37</b>	Timer ON delay (DIO)
<b>Range</b>	<b>【0.0~6000.0】 Sec</b>
<b>03-38</b>	Timer OFF delay (DIO)
<b>Range</b>	<b>【0.0~6000.0】 Sec</b>

When one of multi-function input from parameters 03-00 to 03-07 (S1 to S8) is set to 35 (counting function input) and one of multi-function output parameters 03-11 ,03-12 (R1A-R1C to R4A- R4C and PH1 to PH4) is set to 27 (counting function output), the counting function will be enabled.

- . These input and output are used for the ON/OFF delay time of general I/O.
- . Timing parameter(03-37/03-38) can avoid the frequent sound of detector and switch and so on.
- . If the turning on time of timing function input is higher the set value of 03-37, the counting function will turn to ON.
- . If the turning off time of timing function input is higher the set value of 03-38, the counting function will turn to OFF.
- . The following figure shows an example.

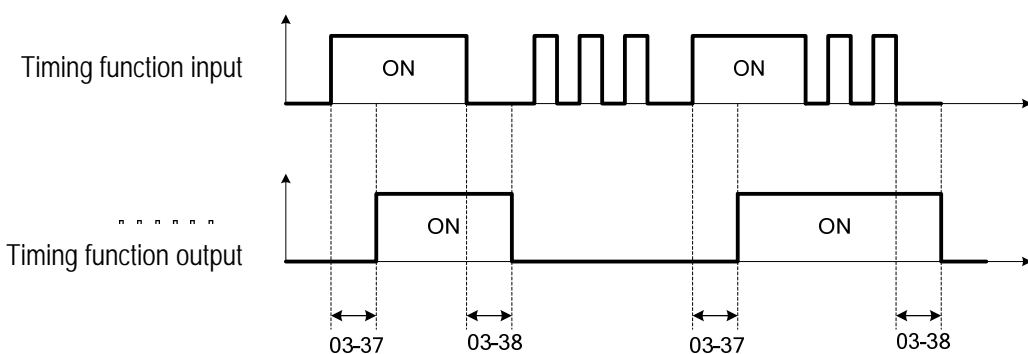

## 04-- External terminal analog signal input(output) function group

<b>04- 00</b>	AI input signal type
<b>Range</b>	<b>【0】</b> : AI1 0~10V                      AI2 0~10V <b>【1】</b> : AI1 0~10V                      AI2 4~20mA <b>【2】</b> : AI1 -10~0~10V                  AI2 0~10V <b>【3】</b> : AI1 -10~0~10V                  AI2 4~20mA
<b>04- 01</b>	AI1 signal scanning and filtering time
<b>Range</b>	<b>【0.00~2.00】 Sec</b>
<b>04- 02</b>	AI1 gain value
<b>Range</b>	<b>【0.0~1000.0】 %</b>
<b>04- 03</b>	AI1 bias voltage value
<b>Range</b>	<b>【-100~100.0】 %</b>
<b>04- 05</b>	AI2 function setting
<b>Range</b>	<b>【0】</b> : Auxiliary frequency <b>【1】</b> : Frequency Reference Gain <b>【2】</b> : Frequency Reference bias <b>【3】</b> : Output Voltage Bias <b>【4】</b> : Coefficient of acceleration and deceleration reduction <b>【5】</b> : DC braking current <b>【6】</b> : Over-torque Detection Level <b>【7】</b> : Stall prevention Level During Running <b>【8】</b> : Frequency lower limit <b>【9】</b> : Jump frequency 4 <b>【10】</b> : Added to AI1 <b>【11】</b> : Positive torque limit <b>【12】</b> : Negative torque limit <b>【13】</b> : Regenerative Torque Limit <b>【14】</b> : Positive / negative torque limit <b>【15】</b> : Torque command/ Torque limit (in speed control) <b>【16】</b> : Torque compensation <b>【17】</b> : No function
<b>04- 06</b>	AI2 signal scanning and filtering time
<b>Range</b>	<b>【0.00~2.00】 Sec</b>
<b>04- 07</b>	AI2 gain value
<b>Range</b>	<b>【0.0~1000.0】 %</b>
<b>04- 08</b>	AI2 bias voltage value
<b>Range</b>	<b>【-100.0~100.0】 %</b>

(1) Analog Input Level Adjustment AI1, AI2 (04-02, 04-03, 04-07, 04-08)

. For each of the different analog inputs AI1 and AI2, the corresponding gain and bias should be listed separately.

AI1 is adjusted by 04-02 and 04-03, AI2 is adjusted by 04-07 and 04-08. As to the analog input and related parameter, please refer to Figure 4.3.35.

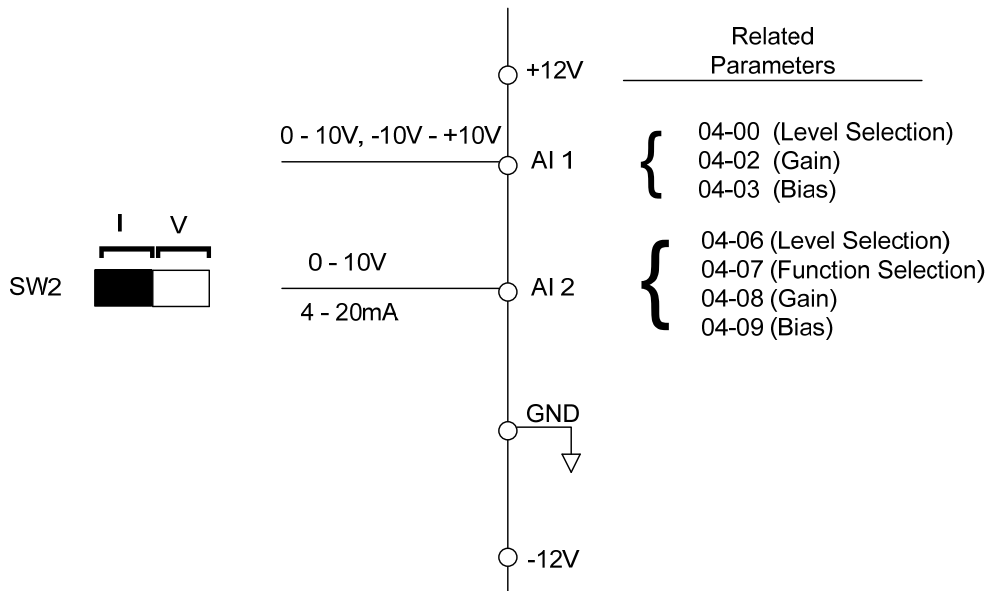

Figure 4.3.35 Analog input and parameter

. For the gain and bias settings, refer to Figure 4.3.36.

gain : Set the frequency reference corresponding to 10V, -10V or 20mA inputs, and as the largest proportion of the maximum output frequency (set the maximum output frequency 01-02 to 100%).

bias : Set the frequency reference corresponding to 0V or 4 mA inputs, and as the largest proportion of the maximum output frequency (set the maximum output frequency 01-02 to 100%).

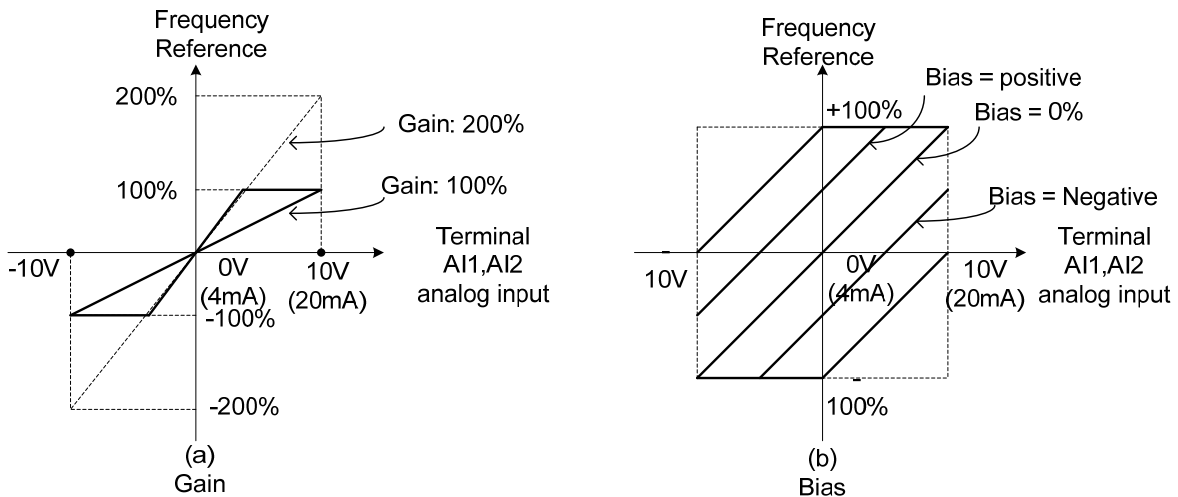

Figure 4.3.36 Gain and bias operations (for frequency reference signal)

**(2) AI1 signal scanning and filtering time (04-01)**

**(3) AI2 signal scanning and filtering time (04-06)**

. All analog inputs (AI1, AI2) have their own step delay digital filters. This setting is used to filter out the momentary change of the analog input signal or the noise. When this setting is added, the system response will reduce and the interference protection will increase.

. Filter time constant (Setting range: 0.00 to 2.00 seconds) is defined as the time that the input step signal reaches 63% of the final value.

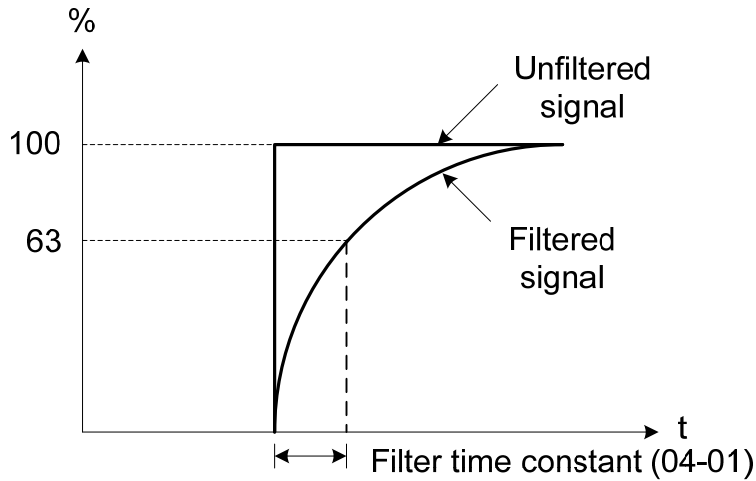

**Figure 4.3.37 Filter time constant**

(3) AI2 function setting (04-05).

. AI2 is multi-function analog input terminal. For function setting, please refer to Table 4.3.11.

**Table 4.3.11 Multi-function analog input list (04-05 setting )**

	Function			Control mode				
	Name	Screen display		V/F	V/F + PG	SLV	SV	PM SV
0	Auxiliary frequency	AUX.Freq Ref		○	○	○	○	○
1	Frequency Reference Gain (FGAIN)	Freq Ref Gain	Aggregated gain = AI1 = 04-02 * FGAIN	○	○	○	○	○
2	Frequency Reference bias (FBIAS)	Freq Ref Bias	Aggregated bias = AI1 = 04-03 * FBIAS	○	○	○	○	○
3	Output Voltage Bias (VBIAS)	Output Volt Bias	Aggregate output voltage = V/F curve voltage + VBIAS	○	○	X	X	○
4	Coefficient of acceleration and deceleration reduction (K)	Tacc/Tdec Scaling	Actual acceleration and deceleration time = acceleration and deceleration time	○	○	○	○	○
5	DC braking current	DC Inj Current	Adjust the DC braking current (0 ~ 100%) based on analog input. When the inverter rated current = 100%, DC braking current 07-07 is invalid.	○	○	○	X	○
6	Over-torque detection level	Over Tq Level	Change over-torque detection level based on over-torque detection level, at this time, 08-15 is invalid.	○	○	○	○	○
7	Stall prevention Level During Running	Run Stall Level	Adjust the action level (30 % ~ 200 %) of stall prevention in operation based on analog input. The inverter rated current = 100 %.	○	○	X	X	○

	Function			Control mode				
	Name	Screen display		V/F	V/F + PG	SLV	SV	PM SV
8	Frequency lower limit	Ref. Low Bound	Adjust the lower limit (0 to 100%) of frequency command based on analog input, the maximum output = 100%. The lower limit of frequency command is the greater one of the actual frequency command's lower limit 00-13 or the multi-function analog input.	○	○	○	○	○
9	Jump frequency 4	Jump Freq 4	Jump frequency 4. 100% = maximum output frequency	○	○	○	○	○
10	Added to AI1	Add to AI1	Added to AI1. 100% = maximum output frequency	○	○	○	○	○
11	Positive torque limit	Positive Tq Limit	100% = motor's rated torque	X	X	○	○	○
12	Negative torque limit	Negative Tq Limit	100% = motor's rated torque	X	X	○	○	○
13	Regenerative Torque Limit	Regen. Tq Limit	100% = motor's rated torque	X	X	○	○	○
14	Positive / negative torque limit	+/- Tq Limit	100% = motor's rated torque	X	X	○	○	○
15	Torque command/ Torque limit for speed control	Tref/Tq Limit	100% = motor's rated torque	X	X	X	○	○
16	Torque compensation	Tq Compensation	100% = motor's rated torque	X	X	X	○	○
17	No function	No Function	Retain	○	○	○	○	○



(1).Auxiliary frequency( Setting = 0).

. maximum output frequency (01-02, Fmax) =100%。

(2) Frequency Reference Gain (FGAIN) ( Setting =1)。

. When 04-05 is set to 1 (frequency reference gain), the multi-function analog input AI2 can be used to adjust the frequency reference gain of AI1

. The total frequency reference gain of terminal AI1 is the internal gain (04-02) × FGAIN.

. The frequency reference value of AI1 is 100%.

. For FGAIN adjustment, please refer to Figure 4.3.38.

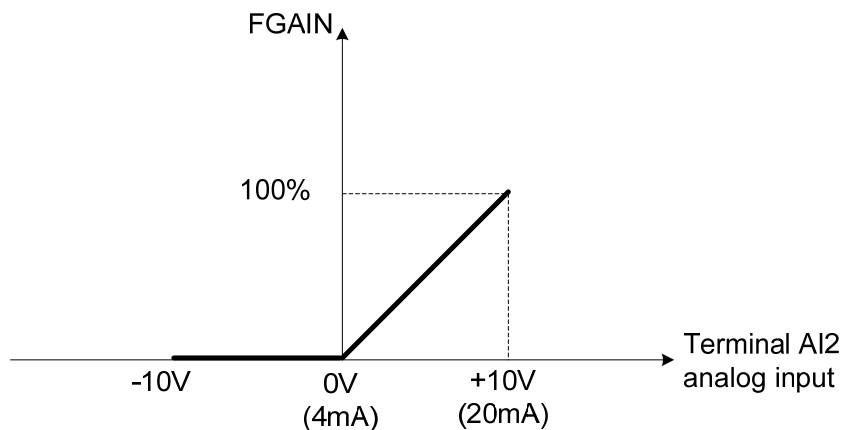

Figure 4.3.38 Frequency gain adjustment

. Example:

When the internal gain of AI1 (04-02) is set to 100% and AI2 to 5V (for example FGAIN = 50%), the reference frequency of terminal AI1 will be 50%, as shown in Figure 4.3.39.

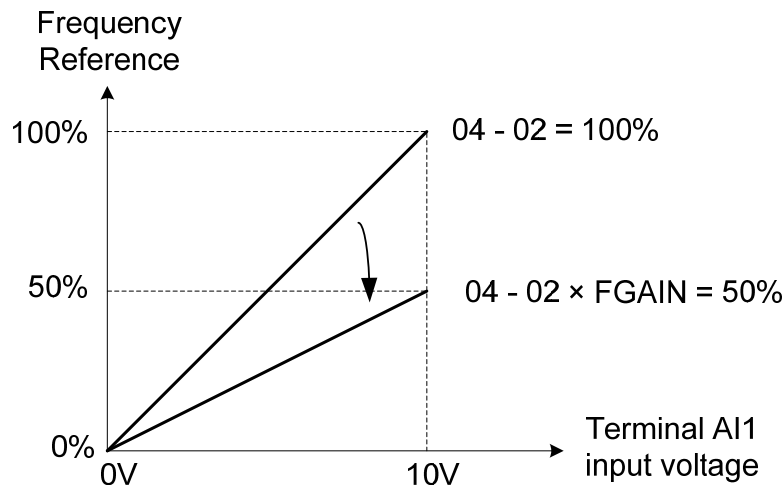

Figure 4.3.39 Frequency reference gain adjustment (example)

(3) Frequency Reference bias (FBIAS) ( Setting = 2)。

. When 04-05 is set to 2 (Frequency Reference bias, FBIAS), multi-function analog input terminal AI2 can be used to adjust the frequency reference bias of AI1.

. The total frequency reference bias of terminal AI1 is the aggregation of terminal AI1's bias and FBIAS's internal bias (04-03) (for example, the total bias = 04-03 + FBIAS).

. AI1 frequency reference value =100%。

. For FBIAS adjustment, please refer to Figure 4.3.40.

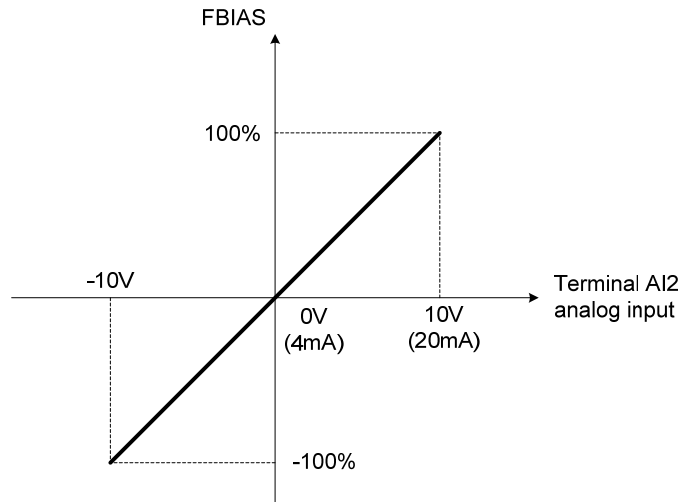

**Figure 4.3.40 Bias adjustment**

.Example:

When 04-02 = 100% (AI1 gain), 04-03 = 0% (AI1 bias), and terminal AI2 is set to 3V, when the input terminal AI1 is 0V, then the reference frequency of terminal AI1 will be 30% , as shown in Figure 4.3.41.

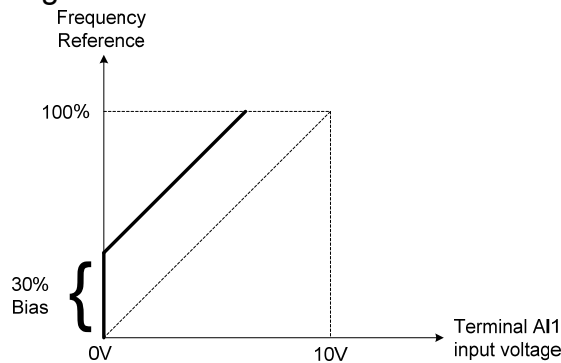

**Figure 4.3.41 Frequency Reference bias adjustment (example)**

(4) Output Voltage Bias(VBIAS) Setting = 3)。

- . When 04-05 is set to 3 (Output Voltage Bias), the multi-function analog input AI2 can be used to adjust the output voltage.
- . The total output voltage of inverter is the aggregation of voltage boosting V/F curve and VBIAS.
- . Maximum output voltage (01-03, Vmax) = 100%
- . About VBIAS adjustment, please refer to Figure 4.3.42.

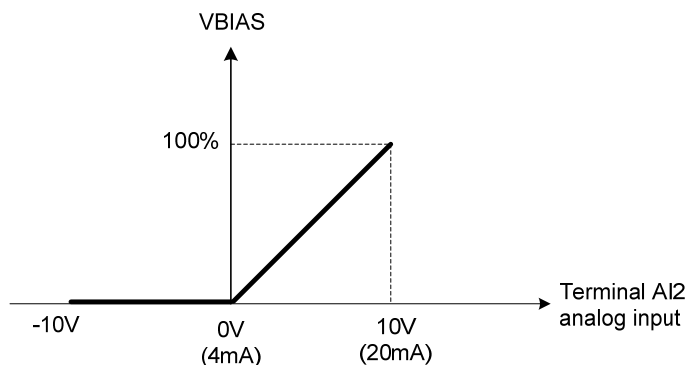

**Figure 4.3.42 Bias adjustment**

(5) Coefficient of acceleration and deceleration reduction (K) ( Setting = 4).

When 04-05 is set to 4 (Coefficient of acceleration and deceleration reduction), multi-function analog input AI2 can be used to adjust the acceleration / deceleration time.

Actual acceleration / deceleration time is shown as following:

$$\text{Actual acceleration / deceleration time} = \frac{\text{actual acceleration / deceleration (00-14 ~ 00-17, 00-21,00-24)}}{K}$$

K

. Acceleration/ Deceleration time (00-14~00-17,00-21~00-24) = 100%。

. Proportion of acceleration/ deceleration time is shown in Figure 4.3.43.

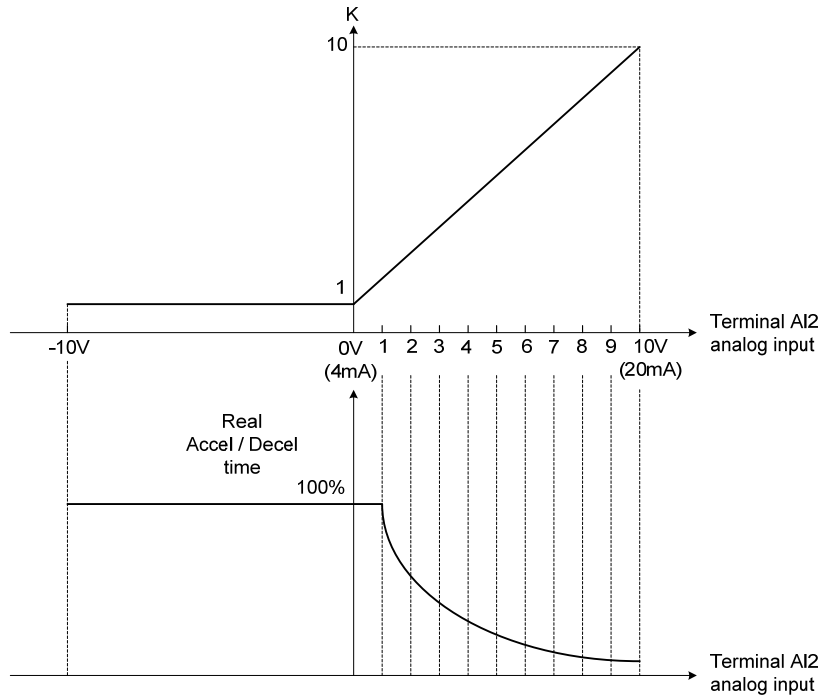

Figure 4.3.43 Operation of proportion of acceleration/ deceleration time

(6) DC braking current (setting = 5)

. When 04-05 is set to 5 (DC braking current), multi-function analog input AI2 can be used to adjust the DC braking current.

. The inverter rated current = 100%

. DC braking current 07-07 setting is closed.

. DC braking current adjustment is shown in Figure 4.3.44.

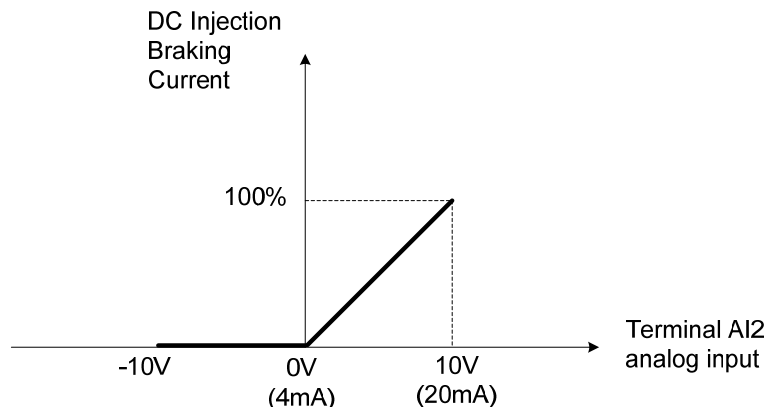

Figure 4.3.44 DC braking current adjustment

(7) Over-torque detection level (setting = 6).

- . When 04-05 is set to 6 (over-torque detection level), multi-function analog input AI2 can be used to adjust the over-torque detection level.
  - . 100% of inverter rated current(V/F or V/F+PG control mode)。
  - . 100% motor rated torque (SLV or SV control mode)。
- . If the multi-function analog input is used to adjust the over-torque level, the internal over-torque detection level (08-15) will be invalid.

. Please refer to the following figure 4.3.45.

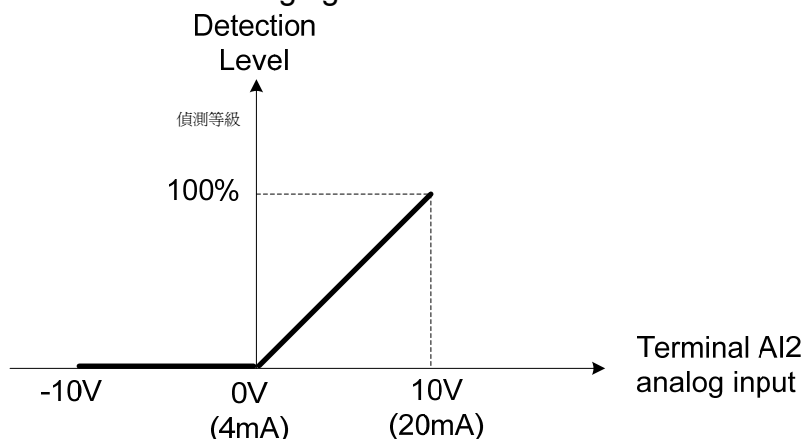

Figure 4.3.45 Over-torque/less torque detection level adjustment

(8) Stall prevention Level During Running ( Setting = 7)

- . When 04-05 is set to 7 (stall prevention level in operation),the multi-function analog input AI2 can be used to adjust the stall prevention level in operation.
- . Inverter rated current = 100%。
- . If AI2 given (04-05 = 7) and parameter 08-03 (Stall prevention level in operation) are used, then the less value of the above two will become the stall prevention level in operation.
- .Application example: If the motor capacity is less than that of the inverter, the operation and the stall prevention of the motor is based on the factory settings, multi-function analog input AI2 can be used to reduce the stall prevention level in operation. Please refer to the following figure 4.3.46.

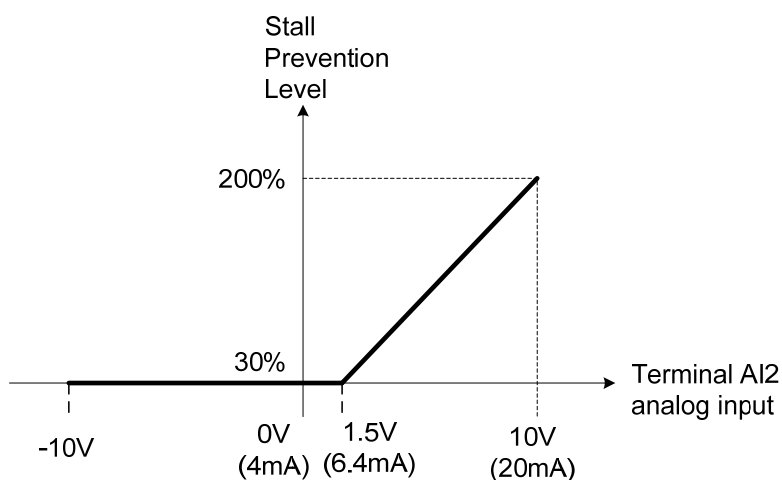

Figure 4.3.46 Stall prevention level adjustment in operation

(9) Frequency lower limit ( Setting = 8).

- . When 04-07 is set to 8 (lower limit of frequency reference), the multi-function analog input AI2 can be used to adjust the lower limit of frequency reference.
- . maximum output frequency ( $F_{max}$ , 01-02) = 100%.
- . The actual lower limit is determined by the corresponding maximum value of 00-13 (frequency lower limit) setting value and multi-function analog input AI2.
- . Please refer to the following figure 4.3.47.

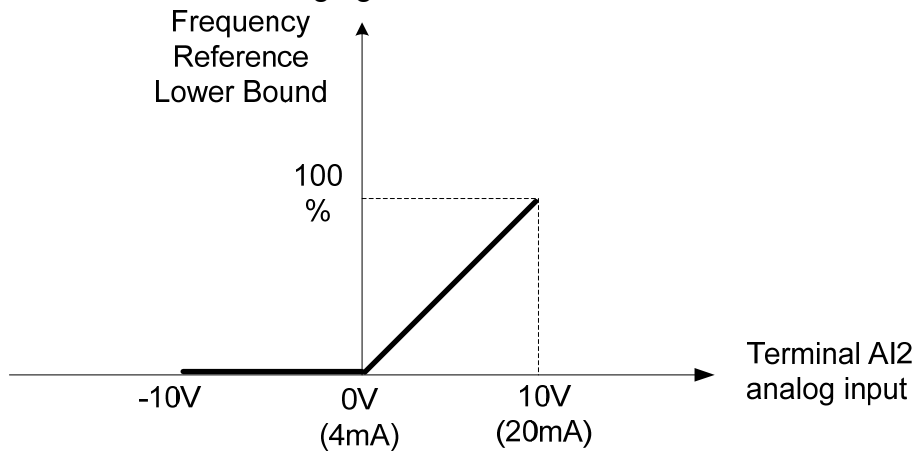

Figure 4.3.47 Adjustment of lower limit of frequency reference

(10) Jump frequency 4 ( Setting = 9)

- . When 04-05 is set to 9 (Jump frequency 4), the multi-function analog input AI2 can be used to adjust the Jump frequency 4.
- . maximum output frequency (01-02,  $F_{max}$ ) = 100%.
- . When 11-08 to 11-10 are set to 0.0Hz, the Jump frequency function is turned off. Refer to the following figure 4.3.48.

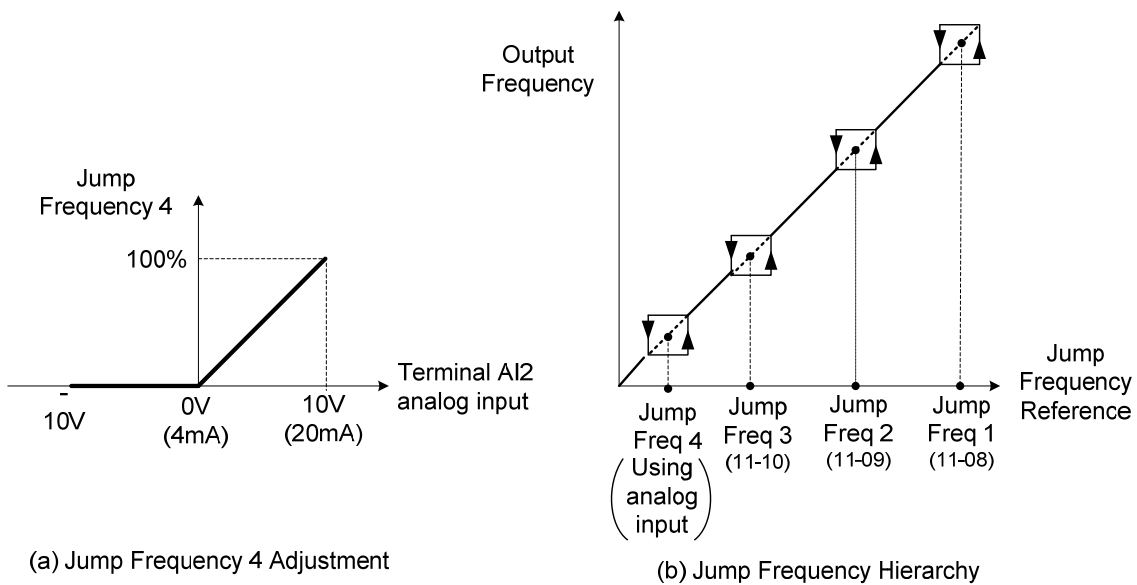

Figure 4.3.48 Jump frequency 4 Setting Operation

(11) Added to AI1 ( Setting = 10)

. When 04-05 (AI2 function selection) is set to 10 (and add to AI1), then the frequency reference value equaling to the AI2 analog input signal will be added to AI1 as a bias. Refer to the following figure 4.3.49.

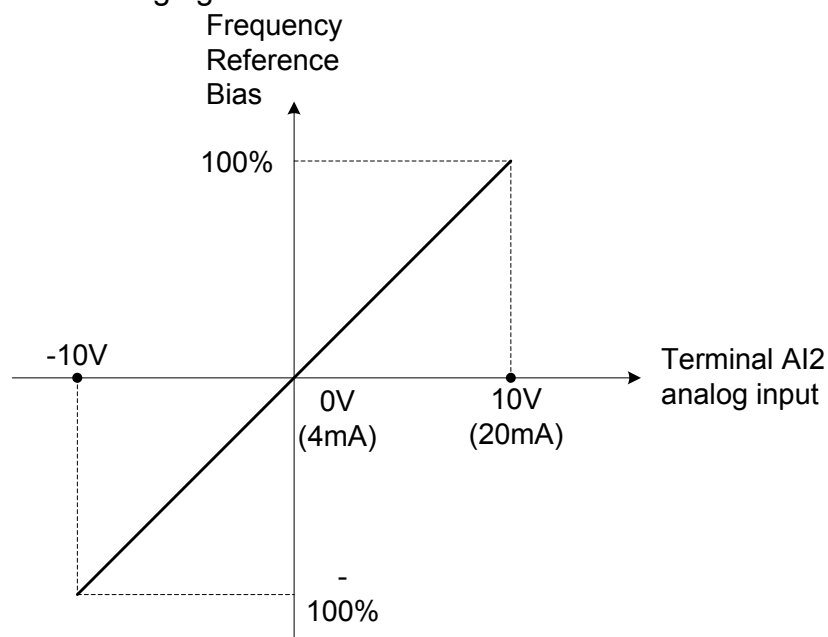

Figure Operation of being added to AI1 as bias

. Example:

. When 04-02 (AI1 gain value) = 100%, 04-03 (AI2 gain value) = 0%, and terminal AI2 is set to 2V, if the input terminal AI1 is 0V, the reference frequency of terminal AI1 will be 20 %.

(12) Positive torque limit ( Setting = 11)

(13) Negative torque limit ( Setting = 12)

(14) Regenerative torque limit ( Setting = 13)

(15) Positive / negative torque limits ( Setting = 14)

. For more details on torque limits, please refer to Parameter 21 - torque function group.

(16) Torque reference / torque limit of speed control ( Setting = 15)。

(17) Torque compensation ( Setting =16)。

. For more details about torque control functions, please refer to Parameter 21 - torque function group.

<b>04-11</b>	AO1 function Setting
<b>Range</b>	<b>【0】</b> : Output frequency <b>【1】</b> : Frequency command <b>【2】</b> : Output voltage <b>【3】</b> : DC voltage <b>【4】</b> : Output current <b>【5】</b> : Output power <b>【6】</b> : Motor speed <b>【7】</b> : Output power factor <b>【8】</b> : AI1 input <b>【9】</b> : AI2 input <b>【10】</b> : Torque command <b>【11】</b> : q -axis current <b>【12】</b> : d-axis current <b>【13】</b> : Speed deviation <b>【14】</b> : Retain <b>【15】</b> : ASR output <b>【16】</b> : Retain <b>【17】</b> : q-axis voltage <b>【18】</b> : d-axis voltage <b>【19】</b> : Retain <b>【20】</b> : Retain <b>【21】</b> : PID input <b>【22】</b> : PID output <b>【23】</b> : PID target value <b>【24】</b> : PID feedback value <b>【25】</b> : Output frequency of the soft starter <b>【26】</b> : PG feedback <b>【27】</b> : PG compensation volume (VF+PG)
<b>04-12</b>	AO1 gain value
<b>Range</b>	<b>【0.0~1000.0】</b> %
<b>04-13</b>	AO1 bias-voltage value
<b>Range</b>	<b>【-100.0~100.0】</b> %
<b>04-16</b>	AO2 function Setting
<b>Range</b>	Range and definition are the same as those of 04-11
<b>04-17</b>	AO2 gain value
<b>Range</b>	<b>【0.0~1000.0】</b> %
<b>04-18</b>	AO2 bias-voltage value
<b>Range</b>	<b>【-100.0~100.0】</b> %

.For the analog output and related parameters, please refer to the following figure 4.3.50 .

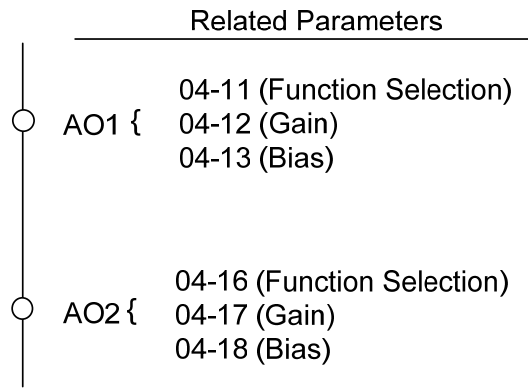

**Figure 4.3.50 Analog output and related parameters**

- (1). Adjustment of analog output AO1 and AO2 (04-12, 04-13 and 04-17, 04-18).
- . By using 04-12 to adjust AO1 and 04-17 to adjust AO2's gain, 04-13 to adjust AO1 and 04-18 to adjust AO2's bias, the output voltage or current or multi-function analog output terminals AO1 and AO2 can be adjusted.
  - . Set the gain adjustment so that the output (10V) and the output of monitoring option are corresponding by 100%.
  - . As to bias, the output characteristics with 10V will correspond to 100% of proportion for offset.
  - . As to the analog output level adjustment, please refer to Figure 4.3.51.

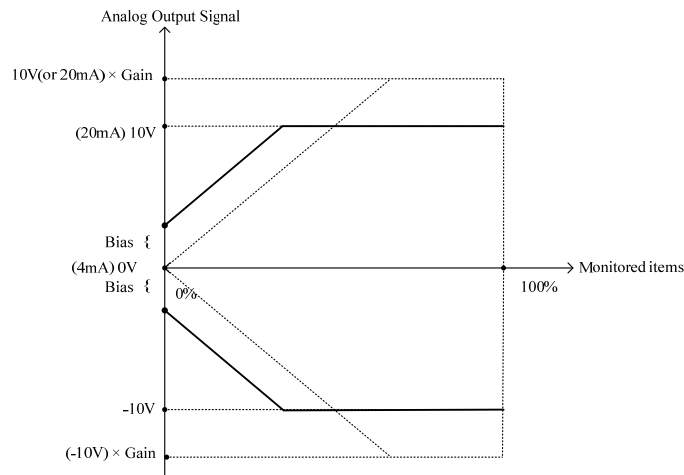

**Figure 4.3.51 Analog output level adjustment**

- (2). Selection of analog output terminals function (04-11 and 04-16).
- . For the function options, please refer to the table 4.3.12.



**Table 4.3.12 Selection of analog output terminals function (04-11 and 04-16).**

04-11, 04-16 Setting	Function (Screen display)	Monitoring paramters 12 Group	Remark
0	Output Freq	12-17	
1	Freq Ref	12-16	
2	Output Voltage	12-19	
3	DC Voltage	12-20	
4	Output Current	12-18	
5	Output KW	12-21	
6	Motor Speed	12-22	
7	Output PF	12-23	
8	AI1 Input	12-25	
9	AI2 Input	12-26	
10	Torque Ref	12-27	
11	Current Iq	12-28	
12	Current Id	12-29	
13	Speed Deviation	12-30	
14	Retain		
15	ASR Output	12-32	
16	Retain	-	
17	Voltage Ref Vq	-	
18	Voltage Ref Vd	-	
19	Retain	-	
20	Retain	-	
21	PID Input	12-36	
22	PID Output	12-37	
23	PID Setpoint	12-38	
24	PID Feedback	12-39	
25	Output Freq (SFS)	-	
26	PG Feedback	12-33	
27	PG Compensation volume	12-34	

**05-- Multi-Speed Group**

<b>05- 00</b>	Acceleration and deceleration selection of multi-speed
<b>Range</b>	<p><b>【0】</b> : Speed acceleration and deceleration time are set by the acceleration and deceleration time 1 ~ 4.</p> <p><b>【1】</b> : Independent setting of speed set acceleration and deceleration time</p>

<b>05- 01</b>	Frequency setting of speed-stage 0
<b>Range</b>	<p><b>【0.0~400.00】 Hz</b></p> <p><b>【0.0~1200.0】 Hz</b> (when 00-31 = 1)</p>
<b>05-17</b>	Acceleration time setting of multi speed 0
<b>05-18</b>	Deceleration time setting of multi speed 0
<b>05-19</b>	Acceleration time setting of multi speed1
<b>05- 20</b>	Deceleration time setting of multi speed 1
<b>05- 21</b>	Acceleration time setting of multi speed 2
<b>05- 22</b>	Deceleration time setting of multi speed 2
<b>05- 23</b>	Acceleration time setting of multi speed 3
<b>05- 24</b>	Deceleration time setting of multi speed 3
<b>05- 25</b>	Acceleration time setting of multi speed 4
<b>05- 26</b>	Deceleration time setting of multi speed 4
<b>05- 27</b>	Acceleration time setting of multi speed 5
<b>05- 28</b>	Deceleration time setting of multi speed 5
<b>05- 29</b>	Acceleration time setting of multi speed 6
<b>05- 30</b>	Deceleration time setting of multi speed 6
<b>05- 31</b>	Acceleration time setting of multi speed 7
<b>05- 32</b>	Deceleration time setting of multi speed 7

<b>05- 33</b>	Acceleration time setting of multi speed <b>8</b>
<b>05- 34</b>	Deceleration time setting of multi speed <b>8</b>
<b>05- 35</b>	Acceleration time setting of multi speed <b>9</b>
<b>05- 36</b>	Deceleration time setting of multi speed <b>9</b>
<b>05- 37</b>	Acceleration time setting of multi speed <b>10</b>
<b>05- 38</b>	Deceleration time setting of multi speed <b>10</b>
<b>05- 39</b>	Acceleration time setting of multi speed <b>11</b>
<b>5- 40</b>	Deceleration time setting of multi speed <b>11</b>
<b>05- 41</b>	Acceleration time setting of multi speed <b>12</b>
<b>05- 42</b>	Deceleration time setting of multi speed <b>12</b>
<b>05- 43</b>	Acceleration time setting of multi speed <b>13</b>
<b>05- 44</b>	Deceleration time setting of multi speed <b>13</b>
<b>05- 45</b>	Acceleration time setting of multi speed <b>14</b>
<b>05- 46</b>	Deceleration time setting of multi speed <b>14</b>
<b>05- 47</b>	Acceleration time setting of multi speed <b>15</b>
<b>05- 48</b>	Deceleration time setting of multi speed <b>15</b>
<b>Range</b>	<b>【0.0~6000.0】 Sec</b>

- **When 05- 00 = 【0】 , the acceleration and deceleration time of multi-speed (0~ 15) 16 are determined by 00-14~00-17/00-21~00-24.**
- **When 05- 00 = 【1】 , the acceleration and deceleration time of multi-speed (0~ 15) 16 are calculated by 05- 17~05- 48 and not determined by 00-14~00-17/00-21~00-24.**

**Function description:**

- When operating The formula of acceleration / deceleration time in operation: the denominator takes the maximum output frequency as the base.

$$\text{Acceleration time of reaching set frequency} = \frac{\text{Acceleration time of group 0 x set frequency}}{\text{Maximum output frequency}}$$

$$\text{Deceleration time of reaching set frequency} = \frac{\text{Deceleration time of group 0 x set frequency}}{\text{Maximum output frequency}}$$

- **When 01- 00= 【F】 , maximum output frequency =01-02 Setting , 01- 00≠ 【F】 , maximum output frequency =50.00(or 60.00/90.00/120.0/180.0)**
- **Example : 01- 00≠ 【F】 , 01- 02= 【50】 hz ( maximum output frequency ) , 05- 02= 【10】 hz (multi-step speed 0), 05-17= 【5】 s(Acceleration time), 05-18= 【20】 s(Deceleration time), then**

$$\text{Actual acceleration time of speed 0} = \frac{(\text{parameter 05-17}) \times 10 \text{Hz}}{\text{parameter 01-02}} = 1(\text{s})$$

$$\text{Actual deceleration time of speed 0} = \frac{(\text{parameter 05-18}) \times 10 \text{Hz}}{\text{parameter 01-02}} = 4(\text{s})$$

➤ When 05-00=【1】 , there are two modes for time setting

Example: Setting : 00-02=【1】 (ExternalTerminal Operation); Terminal S1: 03-00=【0】 (Forward /Stop );

Terminal S2: 03-01=【1】 (Reversal /Stop ); Terminal S3: 03-02=【2】 (Speed 1);

Terminal S4: 03-03=【3】 (Speed 2); Terminal S5: 03-03=【4】 (Speed 3);

**Mode 1:**

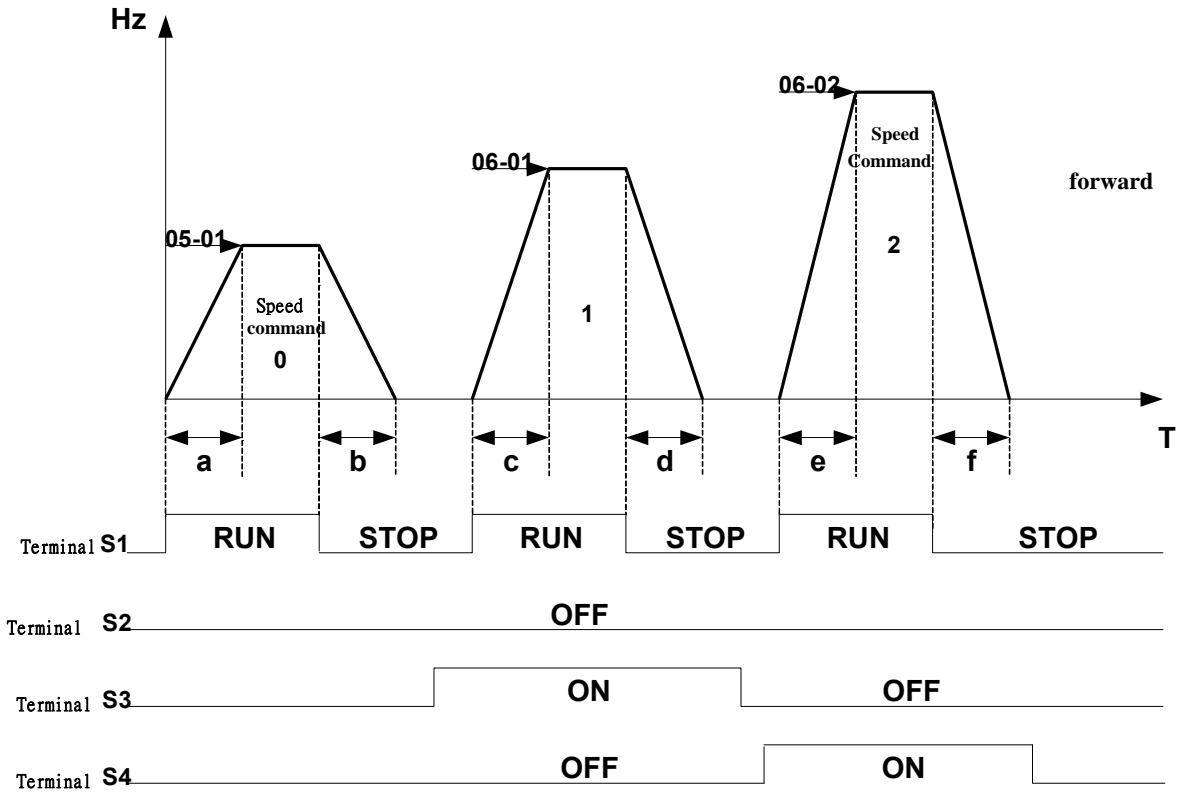

If the operation command is intermittent, each speed acceleration and deceleration time (a ~ f) is calculated according to the following method.

Example :  $a = \frac{(05-17) \times (05-01)}{01-02}$  ,  $b = \frac{(05-18) \times (05-01)}{01-02}$  ,  $c = \frac{(05-19) \times (06-01)}{01-02}$

$d = \frac{(05-20) \times (06-01)}{01-02}$

$e = \frac{(05-21) \times (06-01)}{01-02}$  ,  $f = \frac{(05-22) \times (06-02)}{01-02}$  ..... Unit (sec)

**MODE 2:**

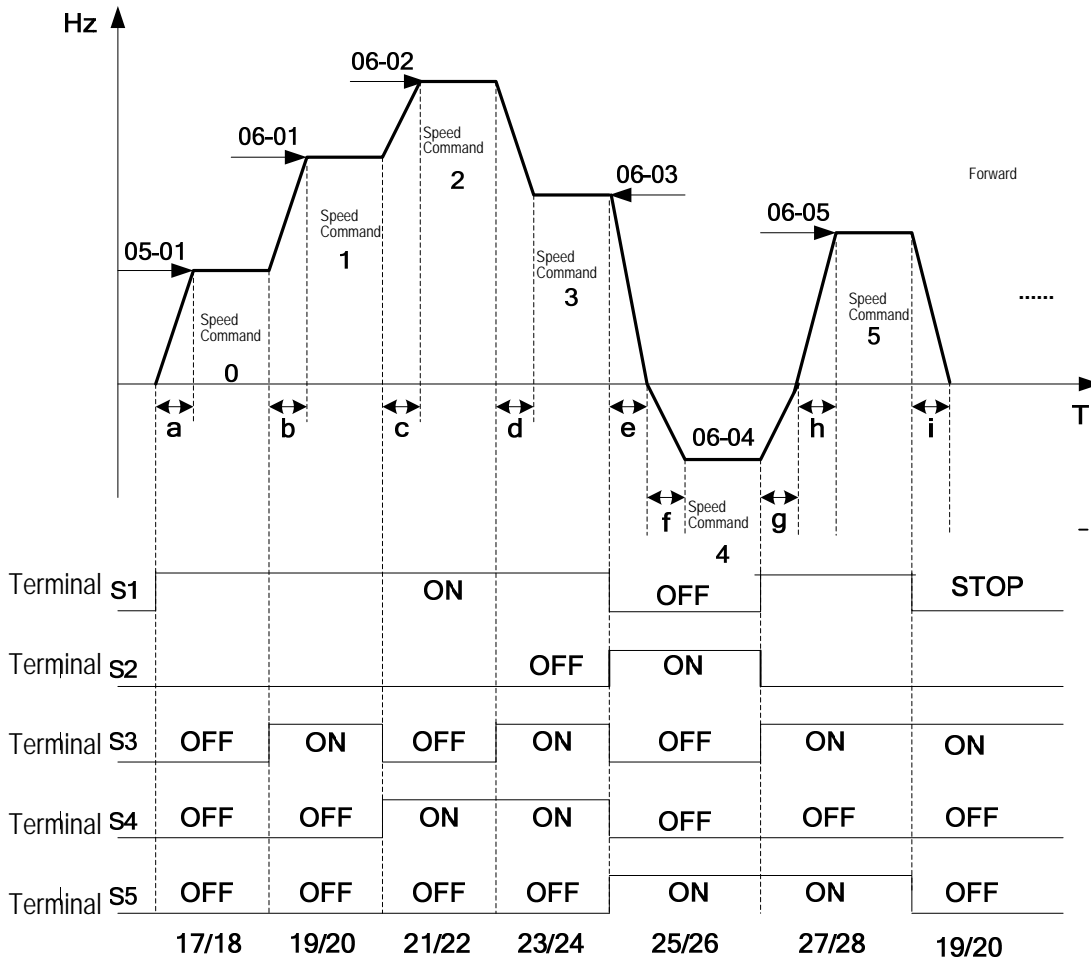

If the operation command is continues, each speed acceleration and deceleration time (a ~ f) is calculated according to the following method.

Example :  $a = \frac{(05-17) \times (05-01)}{01-02}$  ,  $b = \frac{(05-19) \times [(06-01) - (05-01)]}{01-02}$

$c = \frac{(05-21) \times [(06-02) - (06-01)]}{01-02}$  ,  $d = \frac{(05-24) \times [(06-02) - (06-03)]}{01-02}$

$e = \frac{(05-26) \times (06-03)}{01-02}$  ,  $f = \frac{(05-25) \times (06-04)}{01-02}$  ,  $g = \frac{(05-27) \times (06-04)}{01-02}$

$h = \frac{(05-27) \times (06-05)}{01-02}$  ,  $i = \frac{(05-19) \times (06-05)}{01-02}$  ..... Unit (sec)

## 06-- Automatic program operation function group

<b>06- 00</b>	Automatic operation mode selection
<b>Range</b>	<p><b>【0】</b> : Invalid</p> <p><b>【1】</b> : Execute a single cycle operation mode. Restart speed is based on the previous stopped speed.</p> <p><b>【2】</b> : Execute continuous cycle operation mode. Restart speed is based on the previous stopped speed.</p> <p><b>【3】</b> : After the completion of a single cycle, the on-going operation speed is based on the speed of the last stage. Restart speed is based on the previous stopped speed</p> <p><b>【4】</b> : Execute a single cycle operation mode. Restart speed will be based on the speed of stage 1.</p> <p><b>【5】</b> : Execute a single cycle operation mode. Restart speed will be based on the speed of stage 1</p> <p><b>【6】</b> : After the completion of a single cycle, the on-going operation speed is based on the speed of the last stage. Restart speed is based on the previous stopped speed.</p>

The frequency of multi-step speed 0 is set by 05-01	
<b>06- 01</b>	Frequency setting of speed-stage 1
<b>06- 02</b>	Frequency setting of speed-stage 2
<b>06- 03</b>	Frequency setting of speed-stage 3
<b>06- 04</b>	Frequency setting of speed-stage 4
<b>06- 05</b>	Frequency setting of speed-stage 5
<b>06- 06</b>	Frequency setting of speed-stage 6
<b>06- 07</b>	Frequency setting of speed-stage 7
<b>06- 08</b>	Frequency setting of speed-stage 8
<b>06- 09</b>	Frequency setting of speed-stage 9
<b>06- 10</b>	Frequency setting of speed-stage 10
<b>06- 11</b>	Frequency setting of speed-stage 11
<b>06- 12</b>	Frequency setting of speed-stage 12
<b>06- 13</b>	Frequency setting of speed-stage 13
<b>06- 14</b>	Frequency setting of speed-stage 14
<b>06- 15</b>	Frequency setting of speed-stage 15
<b>Range</b>	<p><b>【0.00~400.00】 Hz</b></p> <p><b>【0.0~1200.0】 Hz</b> ( when 00-31 = 1)</p>

<b>06- 16</b>	Operation time setting of speed-stage 0
<b>06- 17</b>	Operation time setting of speed-stage 1
<b>06- 18</b>	Operation time setting of speed-stage 2
<b>06- 19</b>	Operation time setting of speed-stage 3
<b>06- 20</b>	Operation time setting of speed-stage 4
<b>06- 21</b>	Operation time setting of speed-stage 5
<b>06- 22</b>	Operation time setting of speed-stage 6
<b>06- 23</b>	Operation time setting of speed-stage 7
<b>06- 24</b>	Operation time setting of speed-stage 8
<b>06- 25</b>	Operation time setting of speed-stage 9
<b>06- 26</b>	Operation time setting of speed-stage 10
<b>06- 27</b>	Operation time setting of speed-stage 11
<b>06- 28</b>	Operation time setting of speed-stage 12
<b>06- 29</b>	Operation time setting of speed-stage 13

<b>06-30</b>	Operation time setting of speed-stage 14
<b>06-31</b>	Operation time setting of speed-stage 15
<b>Range</b>	<b>【0.0~6000.0】 Sec</b>

<b>06-32</b>	Operation direction selection of speed-stage 0
<b>06-33</b>	Operation direction selection of speed-stage 1
<b>06-34</b>	Operation direction selection of speed-stage 2
<b>06-35</b>	Operation direction selection of speed-stage 3
<b>06-36</b>	Operation direction selection of speed-stage 4
<b>06-37</b>	Operation direction selection of speed-stage 5
<b>06-38</b>	Operation direction selection of speed-stage 6
<b>06-39</b>	Operation direction selection of speed-stage 7
<b>06-40</b>	Operation direction selection of speed-stage 8
<b>06-41</b>	Operation direction selection of speed-stage 9
<b>06-42</b>	Operation direction selection of speed-stage 10
<b>06-43</b>	Operation direction selection of speed-stage 11
<b>06-44</b>	Operation direction selection of speed-stage 12
<b>06-45</b>	Operation direction selection of speed-stage 13
<b>06-46</b>	Operation direction selection of speed-stage 14
<b>06-47</b>	Operation direction selection of speed-stage 15
<b>Range</b>	<b>【0】 : Stop 【1】 : Forward 【2】 : Reversal</b>

The automatic operation mode can be achieved by using command setting (05-01,06-01~06-15) of multi-step speed frequency reference, and at the same time linked to the time setting of automatic operation mode automatically (06-16~06-31), with the use of automatic operation setting for selection (06-00). This automatic operation orientation can be set by parameter 06-32~06-47.

- . The automatic operation mode will be invalid if the following functions are enabled:
  1. Frequency wobbling function
  2. PID function

. In automatic operation mode, the multi-step speed reference command1~4(03-00~03-07=2~5) of external terminal is invalid.  
 Example of automatic operation mode:

(1) Single cycle operation (06-00 = 1,4)

Under the special setting, the inverter will perform a single cycle for operation and then stop.

Parameter setting of cycle operation

06-00	=1(single cycle automatic operation mode)
06-32-06-34	=1(Forward for multi-step speed 0 - 2)
06-35	=2(Reversal for multi-step speed 3)
06-36-06-47	=0(Stop for multi-step speed 4 - 15)
05-01	=15 Hz(Multi-step speed 0:15 Hz)
06-01	=30 Hz(Multi-step speed 1:30 Hz)
06-02	=50 Hz(Multi-step speed 2:50 Hz)
06-03	=20 Hz(Multi-step speed 0:20 Hz)
06-16	=20 sec(Multi-step speed 0:20 sec)
06-17	=25 sec(Multi-step speed 1:25 sec)
06-18	=30 sec(Multi-step speed 2:30 sec)
06-19	=40 sec(Multi-step speed 3:40 sec)

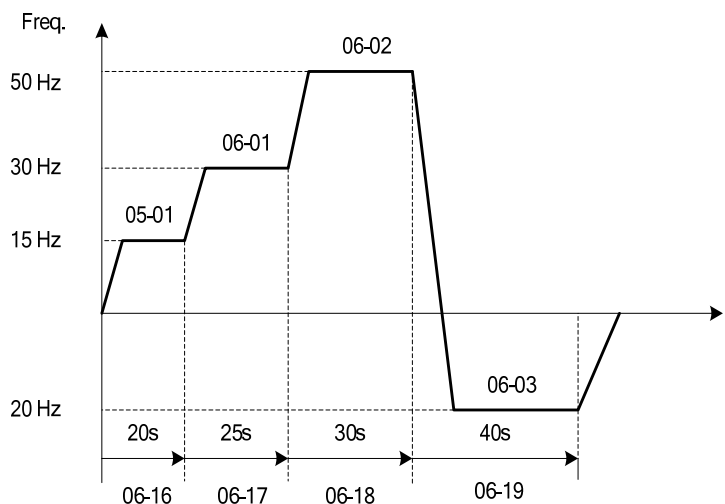

Figure 4.3.52 Single cycle automatic operation (stop)

(2) Periodic operation (06-00 = 2, 5)  
 Inverter will periodically repeat the same cycle.

06-00 = 2

06-01~06-47 the setting is the same as that of Example 1 .

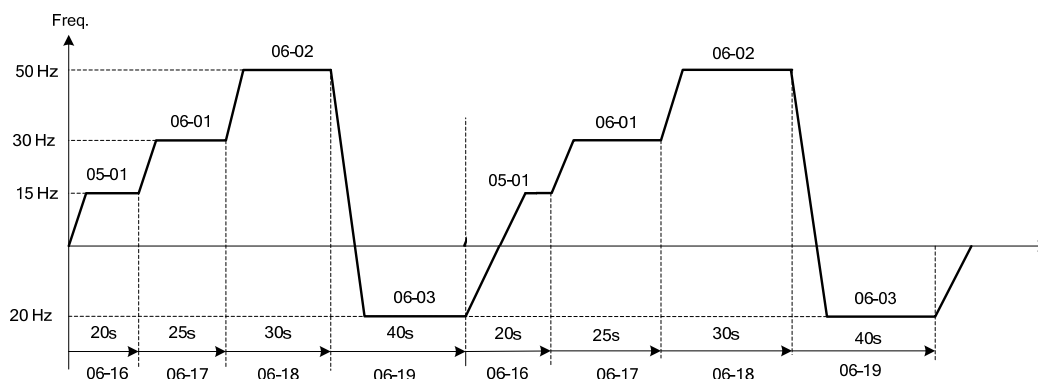

Figure 84.3.53 Periodic automatic operation

(3) Single cycle automatic operation mode (06-00 = 3, 6)

The inverter will finally keep on operating at the speed of final step.

06-00 = 3

06-32~06-35 = 1 (Forward)

06-36~06-47 = 0

Other parameter settings are the same as that of Example 1.

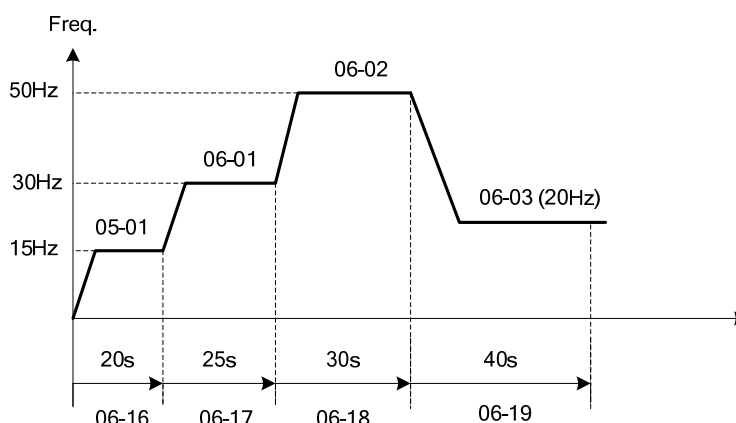

Figure 4.3.54 Single cycle automatic operation (continuous)

06-00 = 1 to 3: If the inverter is restarted after stop, it will start from the incomplete step for further operation based on the setting of 06-00.

06-00 = 4 to 6: If the inverter is restarted after stop, it will start from a new cycle for further operation based on the setting of 06-00.

06-00 Setting	1 to 3	4 to 6
Operation Command	RUN STOP RUN	RUN STOP RUN
Output Frequency		

- Acceleration/deceleration time is set by 00-14 and 00-15 of automatic operation mode.
- If the settings from 06-16 to 06-31 are 0, the automatic operation mode will not be enabled.

## 07- Start/Stop Function group

<b>07- 00</b>	Momentary stop and restart selection
<b>Range</b>	<b>【0】</b> : Restart selection of momentary stop is invalid <b>【1】</b> : Restart selection of momentary stop is valid
<b>07- 01</b>	Restart time of automatic reset
<b>Range</b>	<b>【0~7200】 Sec</b>
<b>07- 02</b>	Restart times of automatic reset
<b>Range</b>	<b>【0~10】</b>

Setting 07-00 to 1, even though the power is momentarily cut off, the inverter can automatically resume the operation of the motor after the power is re-supplied.

07-00 = 0: When momentary power loss is more than 8 ms, "UV" failure (main circuit undervoltage) will be detected.

07-00 = 1: within the power restored time, the inverter will restart.

Automatic restart function will restart the inverter when the failure occurs in operation.

This function should only be used in the applications without harm in safety or without damage on device. It will be closed by setting 07-00 (Momentary stop and restart selection) set to 0. The automatic restart function can be used in the following failure occurrences. If the failure is not listed in the following table, the protection function will be enabled while the automatic restart function is not available.

<b>OC</b> (over current)	<b>OL1</b> (motor overload)
<b>GF</b> (ground failure)	<b>OL2</b> (Inverter overload)
<b>FU</b> (DC fuse is opened)	<b>OT</b> (Over-torque detection)
<b>OV</b> (overvoltage)	<b>UT</b> (Under torque detection)
<b>UV</b> (under voltage)	<b>OPL</b> (Output phase loss)
<b>IPL</b> (input phase loss)	
<b>OH</b> (overheat warning)	

### (1) Auto-restart operation

When enabling or clearing the automatic restart function based on the following situations, the auto-restart times will automatically increase:

- a. No error occurs in 10 minutes or longer after the automatic restart.
  - b. When receiving the input of failure clearance, the protection function will be enabled and failure will be confirmed. (e.g: by pressing reset/left key or enabling failure clearance terminal).
  - c. Switching power is being turned on or off.
- . To output an automatic reset signal to one of multi-function digital output R1A-R1C, R2A-R2C, please set parameter 03-11 to 03-12.
- . Automatic restart operation:
- a. When a failure is detected, the inverter will stop output by setting the minimum base block through (07-18), and will display on the digital operator
  - b. After the minimum base block time (07-18), the failure is cleared automatically and the speed search operation will be performed when the automatic restart function is enabled.
  - c. When the total number of failures exceeds the number of automatic restart, by (07-02) setting, the automatic restart function can not be execute and the inverter will stop output. At this moment, the failure contact will act.
- . Please refer to Figure 4.3.55 for the auto-restart operation.



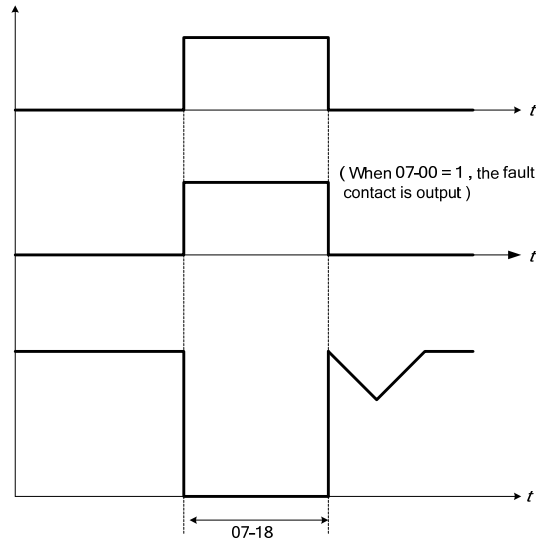

Figure 4.3.55 Auto-restart operation.

(2) Restart time of automatic reset (07-01)

- . When 07-01 is set to 0, the automatic restart time interval is the smallest base block time (07-18).
- . When  $07-01 < 07-18$ , the auto-restart interval is set by 07-18.
- . When  $07-01 > 07-18$ , the automatic restart interval is set by 07-01
- . Refer to Figure 4.3.56 for setting automatic restart interval.

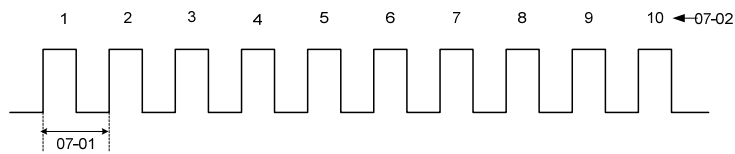

Figure 4.3.56 Automatic restart operation

**Caution** - excessively frequent use of the automatic restart function will damage the inverter.

<b>07- 06</b>	DC Injection Braking Starting Frequency
<b>Range</b>	<b>【0.0~10.0】 Hz</b>
<b>07- 07</b>	DC Injection Braking Current
<b>Range</b>	<b>【0~100】 %</b>
<b>07- 08</b>	DC Injection Braking Time at Stop
<b>Range</b>	<b>【0.00~10.00】 Sec</b>
<b>07- 16</b>	DC Injection Braking Time at Start
<b>Range</b>	<b>【0.00~10.00】 Sec</b>

- . If DC voltage is applied on the operating motor, the motor will produce braking torque, which is DC braking. The parameters from 07-06 to 07-08 and 07-16 will regulate these settings.
- . When performing the speed search function, it is necessary to relieve the DC braking firstly.
- . DC braking function can be enabled by supplying DC current to the motor. This will occur in DC braking time 07-16 before the start and in DC braking time 07-18 in stopping.
- . In response to the start point 07-16 of DC braking time, set the DC braking action time when the motor is started. That can prevent the "windmill effect" due to the load drives the motor, ensuring the stop of motor.
- . If 07-16 is set to 0 (DC Injection Braking Time at Start), the inverter will start from the

minimum output frequency.

- . In response to the DC braking time 07-08 in stopping, set the DC braking action time when the motor is stopped. If 07-08 is set to 0 (DC Injection Braking Time at Stop), when the output frequency is less than the DC braking start frequency 07-06, the inverter output will be closed and the DC braking will be enabled. If the set DC braking start frequency 07-06 is less than the minimum output frequency 01-08, when the output frequency is less than the minimum output frequency 01-08, the DC braking will be enabled.
- . DC braking current level for either start or stop will be set by parameter 07-07. Set the DC braking current (07-07) as a part of the output current proportion that the inverter can withstand (the output current that the inverter can withstand is set to 100%). The DC braking current parameter (07-07) can not be used together with sensor vector control (SV), and can not be set.
- . Increasing the DC braking time (07-08,07-16), or increasing the DC braking current (07-07) can reduce the stop time.
- . For DC braking operation, please refer to Figure 4.3.57.

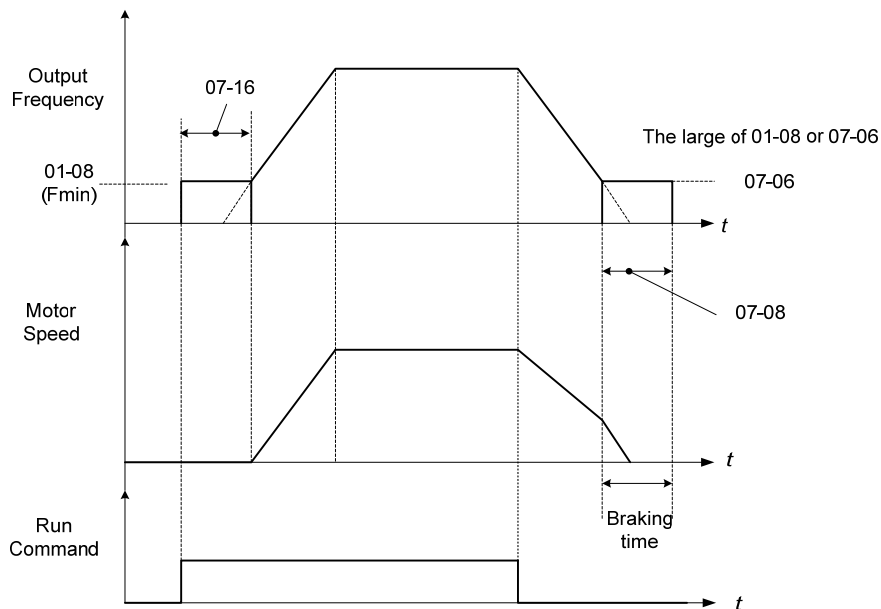

**Figure 4.3.57 DC brake operation**

- . By setting any one of terminals (03-00 to 07) to 33, it is possible to control the DC braking operation by multifunction digital input. As to the DC braking time figure, please refer to Figure 4.3.57.
- . If 04-05 (function option of multi-function analog input AI2) are set to 5 (DC braking current), the analog input can be used to adjust the DC braking current. For DC braking current adjustment, please refer to Figure 4.3.44.

<b>07- 09</b>	Stop mode selection
<b>Range</b>	<b>【0】</b> : Deceleration to stop <b>【1】</b> : Coast to stop <b>【2】</b> : DC braking stop in all fields <b>【3】</b> :Coast to stop with timer

When the stop command is executed, please choose the stop mode. There are four types of stop mode in total, but the DC brake to stop and the coast to stop with timer can not be used under SV mode.

(1) 07-09=0:

- Deceleration to stop based on the setting of 07-09. When the operation command is removed, the motor will decelerate to the minimum output frequency 01-08(Fmin), and then stop.
- Deceleration rate is depended on the deceleration time (factory default: 00-15). When the output frequency has fallen to DC braking initiation frequency (07-06) or the minimum output frequency (01-08), taking the greater setting value, the DC braking is enabled and the motor stops.

. Actual deceleration time =  $\frac{\text{Output frequency when stop command is enabled}}{\text{maximum output frequency } F_{\max} \text{ (01-02)}} \times \text{deceleration time setting value}$

. If the S curve has been set, then it will be added to the overall stop time.

- Please refer to Figure 4.3.58

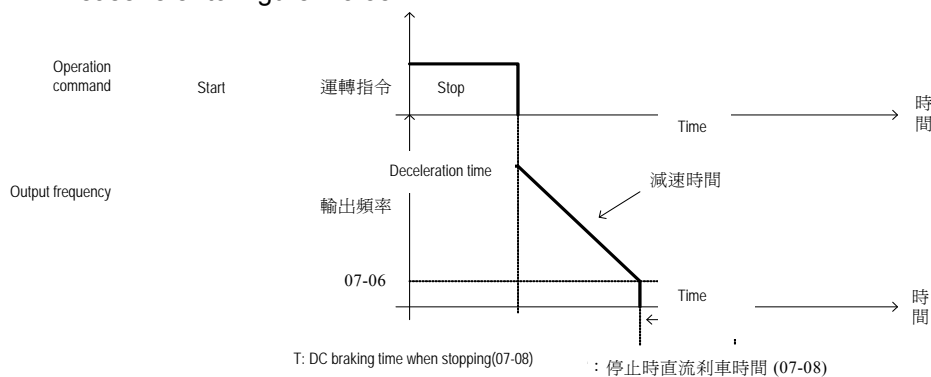

**Figure 4.3.58 Deceleration to stop**

(2)07-09=1:

- . If the operation command is removed, the inverter will be closed, and the motor will be coasting to stop based on the friction deceleration speed of the driving system.
- . After the operation command is removed, the follow-up operation command will be ignored until the end of the minimum base block time (07-18).
- . Please refer to Figure 4.3.59.
- . In SLV mode (00-00 = 2), the next time start after the free operation will enable the speed search function automatically. If the motor is stopped by mechanical braking after the device operation command is removed, please modify the parameter 07-26 to 1 (valid) (parameter 07-26 is only effected in version 1.3 or later).

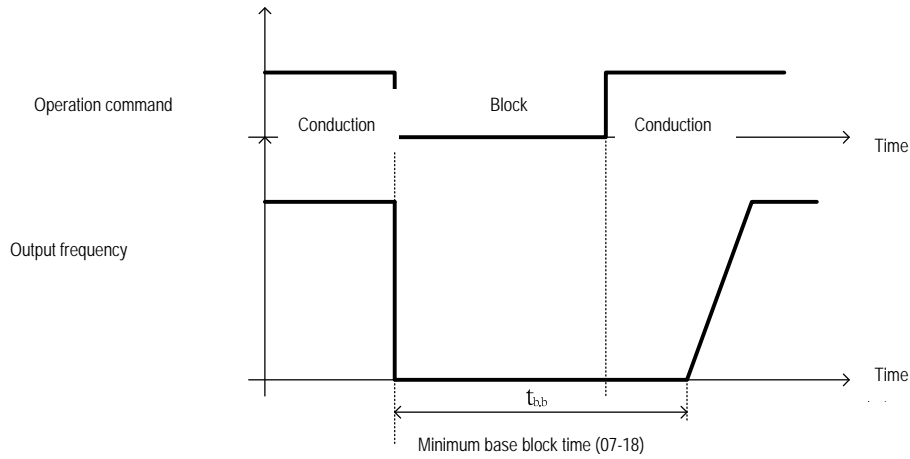

**Figure 4.3.59 Coast to stop**

**(3) 07-09=2:**

. If the operation command is removed, the inverter will perform base block (b.b) based on the minimum base block time (07-18) and the motor will be stopped by DC braking set by 07-07.

.The DC braking time ( $t_{DCDB}$ ) of Figure 4.3.60 is determined by the set value of 07-08 (DC Braking start time) and the frequency that operation command is removed.

$$t_{DCDB} = \frac{(07-08) \times 10 \times \text{output frequency}}{F_{\max} (01-02)}$$

- . If the over-current protection occurs in DC braking process, you can increase the minimum b.b time (07-18) until the protection happens no longer.
- . Please refer to Figure 4.3.60 to understand the function of DC braking to stop.

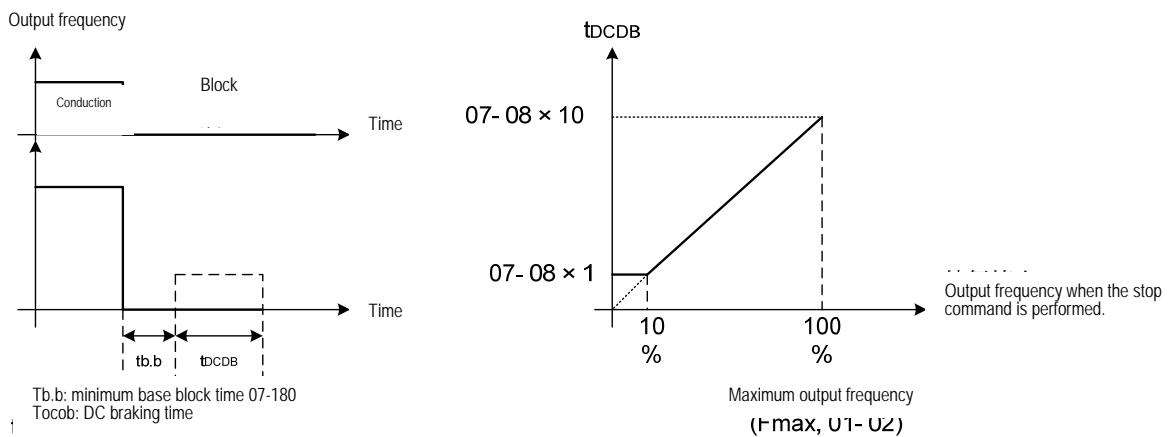

**Figure 4.3.60 DC braking to stop**

**(4) 07-09=3**

- . If the operation command is removed, the inverter will perform base block and the motor will be coasting to stop. Before the achievement of operation waiting time, the inverter will not perform operation and the operation command will be ignored if the operation is input.
- . When the operation command is removed, the operation waiting time (T1) is determined by the deceleration time (00-15,17, 22 or 24) and the output frequency.
- . Please refer to Figure 4.3.61

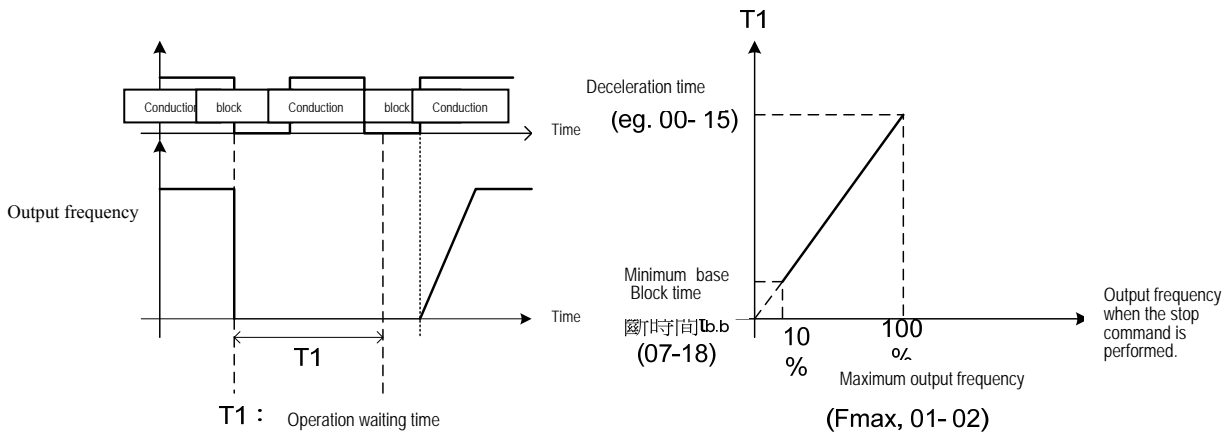

Figure 4.3.61 Coast to stop with timer

<b>07- 13</b>	Low voltage detection level
<b>Range</b>	【220V】 : 150~210V 【440V】 : 300~420V
<b>07- 25</b>	Low voltage detection time
<b>Range</b>	【0.00~1.00】 Sec

Low voltage detection (07-13).

Adjust the 07-13 voltage level from 150 to 210 Vdc ( for type of 220 V level ), or from 300 to 420 Vdc (for type of 440V level) When the voltage is lower than the 07-13 set value (setting value of 07-13/ 1.414 is the AC voltage detection level) and time exceeds the setting value of 07-25, low-voltage error "UV" will act.

For 07-25 = 0.00s, and once the voltage is detected too low, UV will act.

07-25 parameter is only valid in version 1.3 or later.

Set preventive measures:

- ①. The inverter input voltage will limit the output voltage. If the voltage drops excessively much, or if the load is too great, the motor may stall.
- ②. If the input voltage drops below the setting value of 07-13 and the output is cut off momentarily, it will not automatically start when power is restored.

<b>07- 14</b>	Maximum pre-excitation time
<b>Range</b>	【0.00~10.00】 Sec
<b>07- 15</b>	Pre-excitation level
<b>Range</b>	【100~200】 %

If a high starting torque is required before the machine operates, especially for a large capacitor motors, the pre-excitation operation can be used to produce the motor flux.

(1) Pre-excitation time (07-14)

. When the operation command (forward or reversal) is input, the inverter will execute pre-excitation automatically based on the time set by 07-14.

. As Figure 4.3.62 shows, after the flux reaches 100%, set pre-magnetizing time. The time that the flux requires is the function value of motor's electrical time constant.

. Electrical time constant ( quadratic by-pass circuit time constant ) can be calculated by motor parameter setting (group 02)

| Electrical time constant  $T2 = \frac{\text{Motor leakage inductance(02-17)} + \text{motor mutual inductance(02-18)}}{\text{Equivalent resistance of motor rotor (02-16)}}$

.Set the pre-excitatin time (07-14) base on the electrical time constant T2

(2) Pre-excitation initial level (07-15)

- . Use the the pre-excitation initial level (07-15) to provide a higher excitation current within the pre-excitation time (07-14), which will increase the speed and stability for motors.
- . In order to quickly create magnetic flux, reduce the pre-excitation time (07-14) and set the pre-excitation level (07-15) at the high point.
- . If 07-15 is set higher than 100%, providing a high excitation current in the period of the pre-excitation time (07-14), motor’s internal flux establishment time can be shorten. When the setting reaches 200%, the flux establishment time can be reduced by about a half.
- . If the pre-excitation level (07-15) is set to a higher value, motor might generate great noise during pre-excitation.
- .When 100% of the flux has been established and the pre-excitation current backs to 100%, the pre-excitation is completed. Please refer to the following figure 4.3.62.

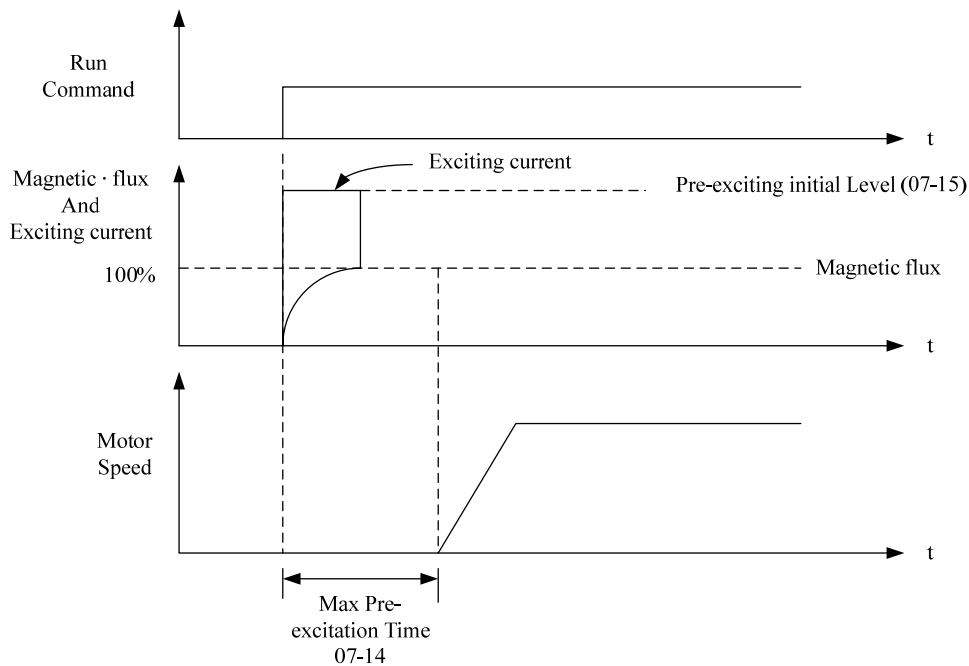

Figure 4.3.62 Pre-excitation operation

<b>07- 18</b>	Minimum base block time
<b>Range</b>	<b>【0.1~5.0】 Sec</b>

For the momentary power failure, the inverter continues to operate after the power is restored (07-00 = 1); therefore the command must always exist. Failure signal will be output by the contacts.

.Once the momentary power failure is detected; the inverter will automatically shut down the output and maintain B.B for a set time. If the set time is 07-18, the residual voltage is expected to almost zero.

. When the momentary power failure time exceeds the minimum base block time (07-18), it immediately starts operation after the speed search. Please refer to the following figure 4.3.63.

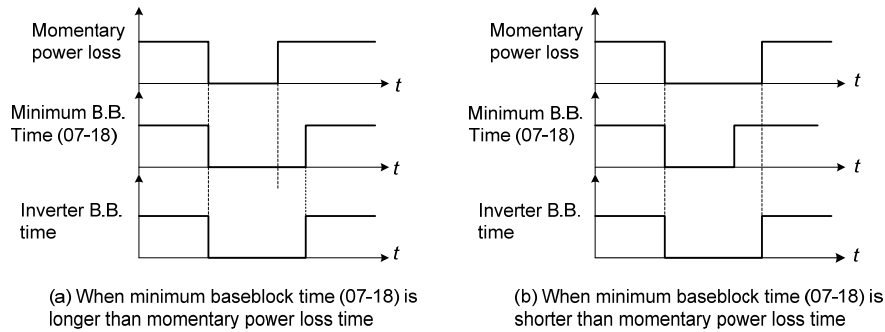

**Figure 4.3.63 Minimum B.B time and momentary power loss time**

Minimum base block time (07-18) is also used to search the speed and DC braking function.

- . Set the minimum base block time required (07-18).
- . Execute speed search or DC braking function, if over-current "OC" has ever occurred, you can increase the setting.
- . After the search of speed activated in this setting is completed, it begins the speed search of momentary power loss and normal situation.

<b>07- 19</b>	Speed Direction Search Operating Current
<b>Range</b>	<b>【0~100】 %</b>
<b>07- 20</b>	Speed Search Operating Current
<b>Range</b>	<b>【0~100】 %</b>
<b>07- 21</b>	Integral time of speed searching
<b>Range</b>	<b>【0.1~10.0】 Sec</b>
<b>07- 22</b>	Delay time of speed searching
<b>Range</b>	<b>【0.0~20.0】 Sec</b>
<b>07-23</b>	Voltage recovery time
<b>Range</b>	<b>【0.1~5.0】 Sec</b>
<b>07- 24</b>	Bidirection Speed Search Selection
<b>Range</b>	<b>【0】 :invalid</b> <b>【1】 :valid</b>
<b>07- 26</b>	<b>Mechanical braking selection</b>
<b>Range</b>	<b>【0】 :invalid</b> <b>【1】 :valid</b>

Speed search function is used to find the actual speed and smoothly start from the speed detected. It is valid when the power is re-supplied after the momentary power failure and when it restarts after failure occurrence.

If the search speed is enabled under the V / F + PG or SV control mode (with PG control), then the inverter will be started from the detected frequency.

- . Set the multi-function digital input terminal to external speed search command 1 or 2. External speed search command 1 (set value = 19) and 2 (set value = 34) can not be set at the same time, otherwise "SE02" (**digital input terminal error**) warning may occur.

If executing speed search by the use of external search command, it is a must to ensure that the speed search command is earlier than operation command, or at least ensure it is effective together with the operation command at the same time. A typical operation sequence is shown in the Figure 4.3.64.

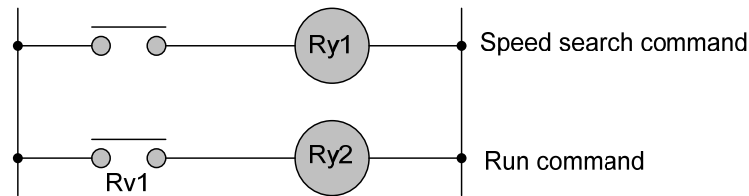

**Figure 4.3.64 Speed search and operation commands**

- . The speed search can not be applied to the motor whose capacity is greater or less two times than the inverter capacity, or to high-speed motor.
  - . When using V / F mode, it is necessary to perform the parameter adjustment of static-type motor.
  - . When using the SLV mode, it is necessary to perform the parameter adjustment of rotary-type motor, using longer motor wires and then perform the parameter adjustment of static-type motor.
  - . The speed search uses current detecting law. 07-24 defines the direction of detection, when
    - ① 07-24=1, bidirectional speed detection:
      - . In the beginning, the current controller will send the step current set by 07-19 to detection the direction. When the direction is determined, the current controller will send the current of speed search set by 07-20 and start the speed search, from the restart after momentary power failure (external speed search command 2, 03-00 to 03-07 = 34), or from the highest frequency (external speed search command 1, 03-00 to 03-07 = 19).
    - ② 07-24=0, bidirectional speed search off:
      - . Ignoring the direction search, the current controller sends the current of speed search for direct speed search.
      - . Usually, if the speed search is not completed (eg, motor speed is too low), speed search timing-out warning will enabled. If this situation occurs frequently, please set 07-19 to enable DC braking and restart.
- (1). Speed Direction Search Operating Current (07-19)
    - . Be used in bidirectional speed search only ( when 07-24 = 1)
    - . Set bidirectional current level
    - . If speed search fails at low speed (above 5Hz), please increase the set value. Note that if set value is too high, it will generate a slight DC braking effect.
  - (2). Speed Search Operating Current (07-20)
    - . Suitable for bidirectional (07-24 = 1) or unidirectional (07-24 = 0) speed search.
    - . Set speed search current Level.
    - . The set value must be lower than the excitation current (02-09) and must equal to the no-load current. If the no-load current is unknown, it is recommended to start from 20% for setting. Excessive speed search current will cause the inverter output saturation.
    - . In the case of momentary power failure, the speed search should be used. If the overcurrent (OC) is detected, increase the minimum base interdiction time (07-18).
  - (3). Integral time of speed searching (07-21)
    - . Suitable for bidirectional (07-24 = 1) or unidirectional (07-24 = 0) speed search.
    - . Set the integral time during speed search.
    - . If OV occurs, increase the set value to make the speed search time longer. You can decrease the set value if quick start is required
  - (4). Delay time of speed searching (07-22)
    - . If there is contactor at the inverter output side, 07-22 search speed can be set to delay the time.
    - . The factory setting is 0.2 second, the inverter begins the speed search after the delay time. If 07-22 = 0.0, the speed search delay function will be disabled.



- (5). Voltage recovery time (07-23). (07-23).
- . Set the voltage recovery time
  - . Set the time that inverter output voltage recovers to normal voltage.
- (6). Bidirectional speed search selection (07-24)
- . =1 open =0 close
  - . When bi-directional speed search is closed, the speed search direction will follow the speed command.
- (7) Mechanical braking function (07-26)
- . = 1 open. = 0 close. (Factory default setting is close)
  - . For SLV mode (00-00 = 2), set the stop mode to the coasting stop (07-09 = 1) or to the coasting stop with timer (07-09 = 3). The next start after the coasting stop will automatically open the speed search function. After the operation command is removed, if the mechanical braking is used to stop the motor, please set this parameter to 1 (open) (07-26 parameter is only valid in software version 1.3 or later).

■ Speed search based on current detection

(a) Speed search at starting

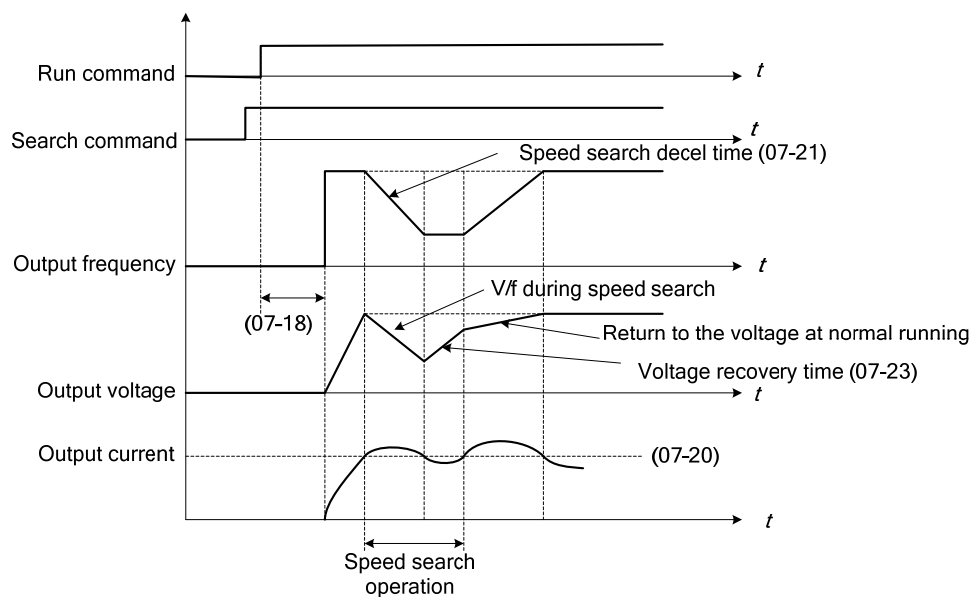
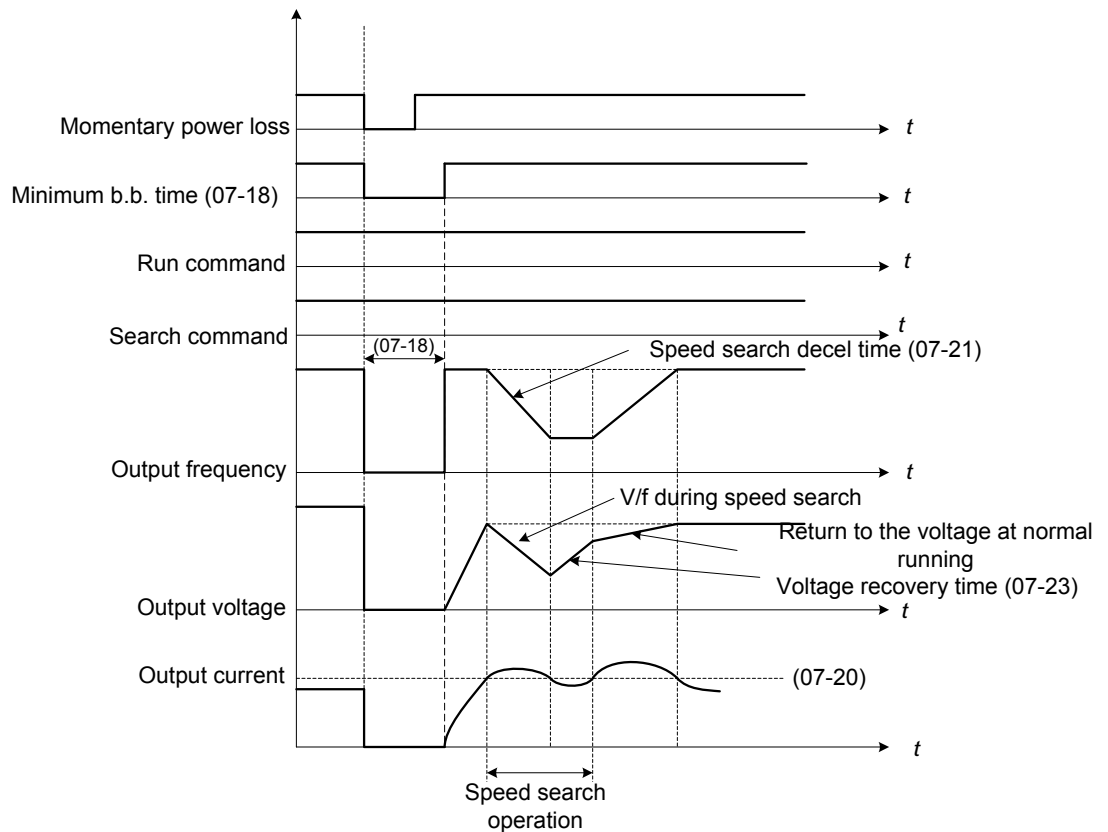

Figure 4.3.65 Speed search at starting

(b) Speed search in recovery period of momentary power failure



**Figure 4.3.66 Speed search in recovery period of momentary power failure**

- If the minimum base block time (07-18) is longer than the momentary power failure time, the speed search begins operation after the minimum base block time (07-18).
- If the minimum base block time (07-18) is short, the speed search operation begins immediately after the power is restored.

## 08-- Protection Function Group

<b>08- 00</b>	Stall prevention function.
<b>Range</b>	<b>【xxx0b】</b> : Stall prevention function is valid in acceleration. <b>【xxx1b】</b> : Stall prevention function is invalid in acceleration. <b>【xx0xb】</b> : Stall prevention function is valid in deceleration. <b>【xx1xb】</b> : Stall prevention function is invalid in deceleration. <b>【x0xxb】</b> : Stall prevention function is valid in operation. <b>【x1xxb】</b> : Stall prevention function is invalid in operation. <b>【0xxxb】</b> : Stall prevention function in operation is based on the first acceleration time. <b>【1xxxb】</b> : Stall prevention function in operation is based on the second acceleration time.
<b>08- 01</b>	Stall prevention level in acceleration
<b>Range</b>	<b>【30~200】</b> %
<b>08- 02</b>	Stall prevention level in deceleration
<b>Range</b>	<b>【330~410】 V : 220V</b> <b>【660~820】 V : 440V</b>
<b>08- 03</b>	Stall prevention level in operation
<b>Range</b>	<b>【30~200】</b> %
<b>08-21</b>	Limit of stall prevention in acceleration
<b>Range</b>	<b>【0~100】</b> %
<b>08-22</b>	Stall prevention detection time in operation
<b>Range</b>	<b>【2~100】 mSec</b>

### Stall prevention in acceleration (08-00=xxx0b)

Stall prevention is used to prevent, during the acceleration function is acting, the generation of over high current due to the high motor load or the demand for rapid acceleration.

. When the stall prevention function (08-00 = xxx0b) is started in the period of acceleration, and the output current of the inverter exceeds 15% of 08-01, the acceleration rate begins to decrease. When it reaches the set value of 08-01, the motor stops

. When the motor capacity is smaller than the inverter capacity, if the motor stalls, you can reduce the 08-01 settings.

. The inverter rated output current should be set to 100% level.

. Refer to the figure 4.3.67 for stall prevention in acceleration.

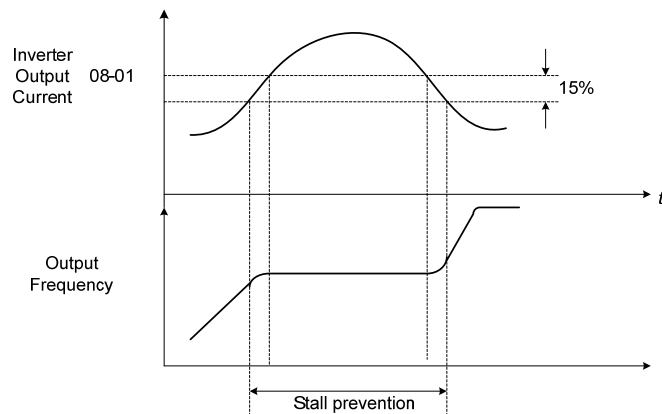

Fig. 4.3.67 Stall prevention in acceleration

.If the motor is used in the constant power (CH) region, the stall prevention level (08-01) will be automatically reduced to prevent the stall.

Within the constant power region, the stall prevention level in acceleration is shown as follows:

$$\text{Stall prevention level in acceleration (in CH region)} = \frac{\text{【Stall prevention level in acceleration (08-01)】} \times \text{【Fbase (01-12)】}}{\text{Output frequency}}$$

08-21 is the limit value that the stall prevention level in CH region is reduced lower than the required level. Refer to the following figure.

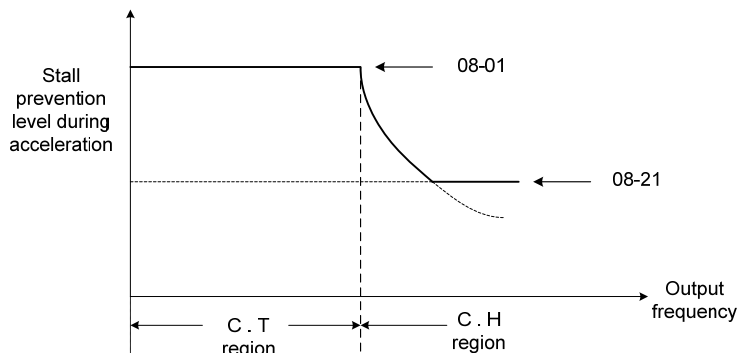

Figure 4.3.68 Stall prevention level and limit in acceleration

### Stall prevention selection in deceleration (08-00=xx0xb)

Stall prevention in deceleration function will automatically delay the deceleration time according to the DC voltage to prevent over-voltage in deceleration.

- . In deceleration, when DC voltage exceeds the stall prevention level, the deceleration will stop. When DC voltage is lower than the detection level, it continues to decelerate.
- . Stall prevention level can be set by 08-02, see Table 4.3.13.

Table 4.3.13 Stall prevention level

Inverter model		08-02 default value (Stall prevention selection in deceleration, DC current)
220V class, 1 to 10HP		395VDC
220V class, 15HP or above models		385VDC
440V class	01-14 <400V	680VDC
	01-14 >400V, 1 to 15HP	790VDC
	01-14 >400V, 20 HP or above models	770VDC

Refer to Figure 4.3.69 for stall prevention in deceleration

When the braking (braking resistance or braking module) is started, set 08-00 = xx1xb (invalid).

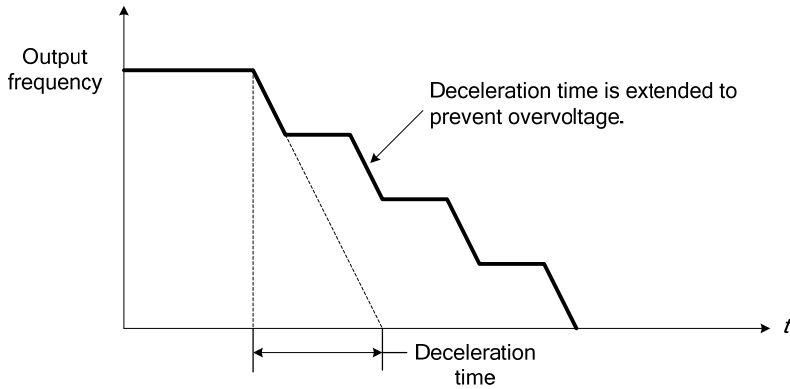

Figure 4.3.69 Stall prevention selection in deceleration

### Stall prevention selection in operation (08-00=x0xxb)

In operation, the stall prevention is valid only in V / F control mode with or without PG.

This function prevents motor stall by automatically reducing the output frequency.

If the inverter output current exceeds the set time of 08-22 and the set level of 08-03, the inverter output frequency will decelerate according to the deceleration time 1 (00-15) or deceleration time 2 (00-17). When the inverter output current drops down to the level (08-03) -2% or less, the output frequency will accelerate. Refer to the following figure 4.3.70.

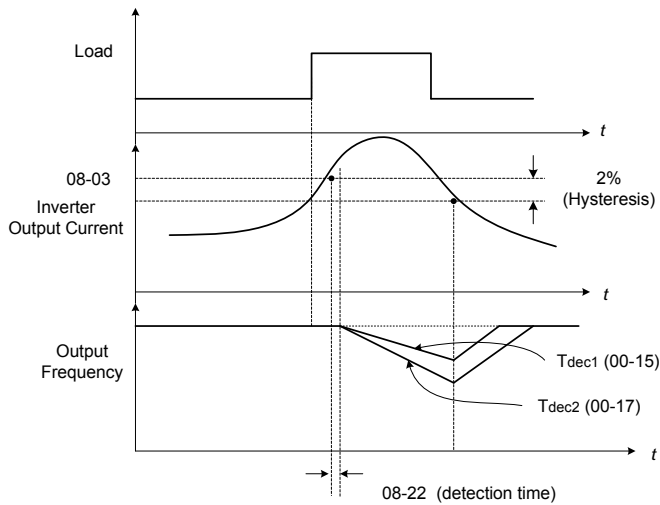

Figure 4.3.70 Stall prevention selection in operation

**Note-** The stall prevention level in operation can be set by multi-function analog input AI2(04-05=7).

<b>08-05</b>	Selection for motor overload protection (OL1)
<b>Range</b>	<b>【xxx0b】</b> : Motor overload is invalid <b>【xxx1b】</b> : Motor overload is valid <b>【xx0xb】</b> : Cold start of motor overload <b>【xx1xb】</b> : Hot start of motor overload <b>【x0xxb】</b> : Standard motor <b>【x1xxb】</b> : Frequency-conversion motor <b>【0xxxb】</b> : Retain <b>【1xxxb】</b> : Retain

Selection for motor overload protection (OL1) (08-05).

- Set the overload protection function for the used motor by 08-05.
- When two or more motors are connected to the same inverter, please turn off the motor overload protection function (set 08-05 = xxx0b), and apply other methods to provide overload protection, for example, connect a thermal overload switch to each motor power.
- When the power supply is normally switched on or off, the motor overload protection function 08-05 = xx1xb (thermal start protection characteristic curve) will be reset each time because of the thermal value when the power is switched off.
- For the motor with cooling fan (special motor for inverter or V / F motor), thermal consumption has nothing to do with the rotation speed, set 08-05 = x1xxb.
- Use electrical overload protection to protect the motor from overload. Set parameter 02-01 according to the rated current on motor nameplate.
- Refer to Figure 4.3.71 for the example of motor overload protection standard curve (08-05 = x0xxb).

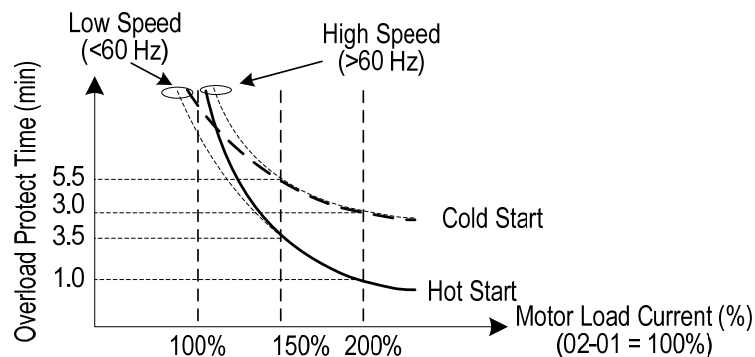

Figure 4.3.71 Motor overload protection curve (example of standard motor)

<b>08-06</b>	Start-up mode of overload protection operation (OL1)
<b>Range</b>	<b>【0】</b> : stop output after overload protection <b>【1】</b> : Continuous operation after overload protection.

- **08-06 = 【0】** : After the electronic relay for motor protection acts, the inverter will immediately be blocked and flash OL1; press RESET or reset the external reset terminal for further operation.
- **08-06 = 【1】** : After the electronic relay for motor protection acts, the inverter will continue to operate, but the inverter will display OL1 in flashing way until the current drops below some value. At this moment, the OL1 flash display will disappear.

<b>08- 08</b>	Automatic voltage regulation (AVR)
<b>Range</b>	<b>【0】</b> : AVR is valid <b>【1】</b> : AVR is invalid

- Automatic voltage regulator is mainly to solve the instability issues of output voltage caused by the instable input voltage.
- When **08-08=【0】** , if the input voltage fluctuates, the output voltage will not change with the input voltage fluctuation.
- When **08-08=【1】** , if the input voltage fluctuates, the output voltage will change with the input voltage fluctuation.

<b>08- 09</b>	Selection of input phase loss protection
<b>Range</b>	<b>【0】</b> : invalid <b>【1】</b> : valid

Selection of input phase loss protection (08-09).

. Adjust 08-09 to start or close the input phase loss protection.

08-09 =0: close the input phase loss protection function.

=1: start the input phase loss protection function.

. If the input phase loss function is enabled and the input phase loss is detected, the digital operator will display the failure message of "IPL input Phase Loss" (IPL), the contacts acts and the inverter begins coast to stop.

.If the output current is less than 30% of the inverter rated current, the input phase loss does not affect the operation.

<b>08- 10</b>	Selection of output phase loss protection
<b>Range</b>	<b>【0】</b> : Invalid <b>【1】</b> : Valid

Selection of output phase loss protection (08-10).

. Adjust 08-10 to start or close the output phase loss function.

08-10 =0: close the output phase loss function

=1: open the output phase loss function

. If the output phase loss function is enabled and the output phase loss is detected, the digital operator will display the failure message of "OPL Output Phase Loss" (OPL), the contacts acts and the inverter begins coast to stop.

. if the output current is less than 10% of the inverter rated current, the output phase loss does not affect the operation.

<b>08- 13</b>	Selection of over-torque detection
<b>Range</b>	<b>【0】</b> : Over-torque detection is invalid <b>【1】</b> : Start to detect when reaching the set frequency <b>【2】</b> : Start to detect when the operation is begun
<b>08- 14</b>	Selection of over-torque action
<b>Range</b>	<b>【0】</b> : Deceleration to stop when over-torque is detected. <b>【1】</b> : Display warning when over-torque is detected. Go on operation.
<b>08- 15</b>	Level of over-torque detection
<b>Range</b>	<b>【0~300】</b> %
<b>08- 16</b>	Time of over-torque detection
<b>Range</b>	<b>【0.0~10.0】</b> Sec
<b>08- 17</b>	Selection of low-torque detection
<b>Range</b>	<b>【0】</b> : Low-torque detection is invalid <b>【1】</b> : Start to detect when reaching the set frequency <b>【2】</b> : Start to detect when the operation is begun
<b>08- 18</b>	Selection of low-torque action
<b>Range</b>	<b>【0】</b> : Deceleration to stop when low-torque is detected

	<b>【1】</b> : Display warning when low-torque is detected. Go on operation
<b>08- 19</b>	Level of low-torque detection
<b>Range</b>	<b>【0~300】 %</b>
<b>08- 20</b>	Time of low-torque detection
<b>Range</b>	<b>【0.0~10.0】 Sec</b>

. Over-torque detection function can increase mechanical load by detecting inverter output current or motor output torque. Less torque detection function reduces the inverter output current or the motor output torque by detecting mechanical load (e.g. belt rupture).

. A treatment technology to determine whether it is over-torque (08-13~ 14) or less torque (08-17 ~ 18) status is setting torque detection parameter

. Settings of over-torque (08-15) / less torque (08-19) detection level are determined by the control method,

(1) For V / f control or V / f + PG control mode, it is 100% of inverter rated output current.

(2) For SLV or SV control mode, the motor output torque is 100% of the rated torque.

. Over-torque /less torque detection signals can be output to multi-function digital output terminals (R1A-R1C, R2A-R2C), by setting parameters from 03-11 to 03-12 (multi-function digital output terminal function selection) to 12, 25. Refer to the following figure 4.3.72 for relevant parameters.

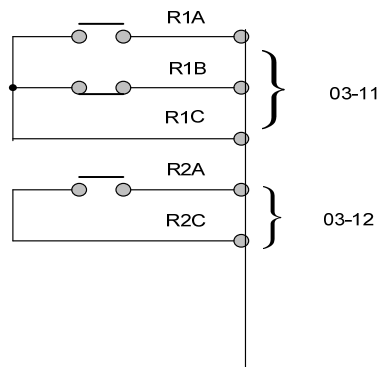

**Figure 4.3.72 Over-torque / less torque detection signals use multi-function digital signal output terminal**

. Setting Example of over-torque detection:

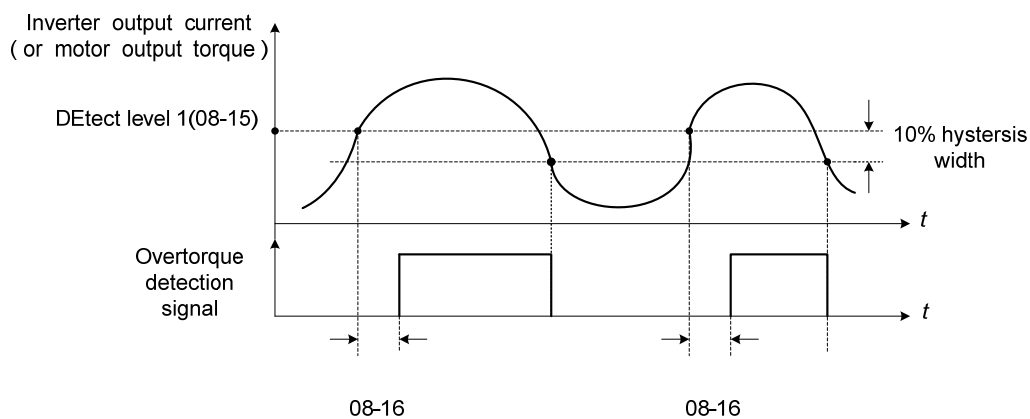

**Figure 4.3.73 Over-torque detection operation**



. Setting Example of less torque detection:

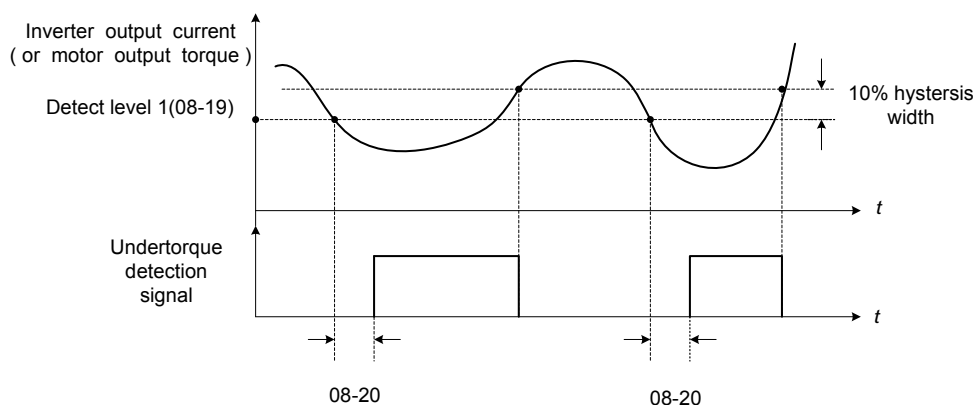

**Figure 4.3.74 Less torque detection operation**

<b>08- 23</b>	Ground Fault (GF) selection
<b>Range</b>	<b>【0】</b> : Invalid <b>【1】</b> : Valid

Ground Fault (GF) protection selection (08-23)

. Adjust 08-23 to enable or disable the ground Fault (GF) protection

08-23 =0: Disable the ground Fault (GF) protection

= 1: Enable the ground Fault (GF) protection

. If the inverter leakage current closes to 50% of inverter rated current and the ground failure function is enabled (08-23), the digital operator will display the failure message of "GF Ground Fault" (GF), failure contact acts and the inverter will coast to stop.

<b>08- 24</b>	External Fault Operation Selection
<b>Range</b>	<b>【0】</b> : Deceleration to stop <b>【1】</b> : Coast to stop <b>【2】</b> : continuous operation
<b>08- 25</b>	Detection selection of external fault
<b>Range</b>	<b>【0】</b> : Immediately detect when the power is supplied. <b>【1】</b> : Start to detect when the operation is started.

## 09- Communication Function Group

<b>09- 00</b>	INV Communication Station Address
<b>Range</b>	<b>【1~31】</b>
<b>09- 02</b>	Baud rate setting (bps)
<b>Range</b>	<b>【0】</b> : 1200 <b>【1】</b> : 2400 <b>【2】</b> : 4800 <b>【3】</b> : 9600 <b>【4】</b> : 19200 <b>【5】</b> : 38400
<b>09- 03</b>	Stop bit selection
<b>Range</b>	<b>【0】</b> : 1 stop bit <b>【1】</b> : 2 stop bit
<b>09- 04</b>	Parity selection
<b>Range</b>	<b>【0】</b> : no Parity <b>【1】</b> : even bit <b>【2】</b> : odd bit
<b>09- 06</b>	Communication error detection time
<b>Range</b>	<b>【0.0~25.5】 Sec</b>
<b>09- 07</b>	Fault stop selection
<b>Range</b>	<b>【0】</b> : Deceleration to stop based on deceleration time 1 when communication fault occurs. <b>【1】</b> : Coast to stop when communication fault occurs. <b>【2】</b> : Deceleration to stop based on deceleration time 2 when communication fault occurs. <b>【3】</b> : Keep operating when communication fault occurs.
<b>09- 09</b>	Waiting time
<b>Range</b>	<b>【5~65】 mSec</b>

Modbus (RS-485) communication port RJ45 (S (+),S (-))built in the inverter can be used to monitor the status of the inverter, read and set parameters

. Modbus communication can perform the following operations, regardless of the settings of 00-05 (Frequency Command Selection) and 00-02 (Operation Command Selection).

- Monitor the operation situation by the controller (PLC)
- Set and read parameters.
- Re-start error.
- Input multi-function command

. Modbus (RS-485) communication specifications are as following.

Items	Specification
Interface	RS-485
Communication cycle	Asynchronous (start - stop synchronization)
Communication parameters	Select Baud rate: 1200, 2400, 4800, 9600, 19200 and 38400 bps Data Length: fixed 8 bits Parity: options of no even and oddbits, even bit or odd bid. Stopt bit: fixed 1 bit
Communication protocol	Modbus (including RTU mode and ASCII mode).
Number of inverter	Maximum 31 units

.Communication procedures and controller

- (1) Turn off the power supply and connect communication lines of the controller and inverter.
- (2) Turn on the power supply.
- (3) Set the required communication parameters (09-00) by the use of digital operator.
- (4) Turn off the power supply,check the digital operator and make sure the display completely disappears.
- (5) Turn on the power again.
- (6) Communicate with the controller

. Modbus (485) communication architecture

- (1) Modbus communication configuration uses a master controller (PLC), and the serial communication of the maximum 31 client controllers.
- (2) The master controller is directly connected to the inverter by RS-485 interface for communication. If the master controller does not provide a RS-485 connector, a RS-232 converter card can be used to connect the master controller and the inverter unit.
- (3) Modbus can control maximum 31 sets of inverter, following the Modbus communication standard.

. Parameters are defined as following:

- (1) Inverter station address (09-00).
  - Inverter address's setting range 1-31
- (2) RS-485 communication Baud rate setting (09-02).
  - 09-02= 0: 1200 bps (bits / second)
  - = 1: 2400 bps
  - = 2: 4800 bps
  - = 3: 9600 bps
  - = 4: 19200 bps
  - = 5: 38400 bps
- (3) Parity selection of RS-485 communication (09-03, 09-04)
  - 09-03 = 0: 1 stop bit
  - = 1: 2 stop bits
  - 09-04 = 0: No parity.
  - = 1: even parity.
  - = 2: odd parity.

- (4) RS-485 communication error detection time (09-06).
- (5) Stop selection of RS-485 communication failure (09-07).
  - = 1: Deceleration to stop by deceleration time 00-15
  - = 2: Coast to stop
  - = 2: Deceleration to stop using the deceleration time of 00-26 (emergency stop time)
  - = 3: Continue to operate (only shows a warning message, press the stop button to stop operation)
- (6) Waiting time of inverter transmission (09-09).
  - Set the waiting time (see Figure 8.1.134). If the sent signals can not be received, more time is needed to change that an command is sent after entering the receiving status, by setting time of 09-09.

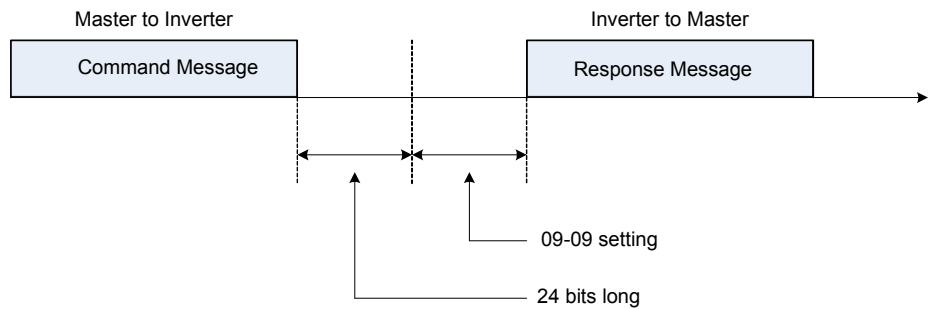

**Figure 4.3.76 Message space**

**10-PID Function Group**

<b>10- 00</b>	PID target value source setting
<b>Range</b>	<b>【1】</b> : AI1 given <b>【2】</b> : AI2 given <b>【3】</b> : Retain <b>【4】</b> : 10-02 given

➤ This parameter is only used when **00- 05= 【5】**

<b>10- 01</b>	PID feedback value source setting
<b>Range</b>	<b>【1】</b> : AI1 given <b>【2】</b> : AI2 given <b>【3】</b> : Retain

Note: **10- 00** and **10- 01** can not be set by the same source. If the set values are the same, then the panel will display **SE05**

<b>10- 02</b>	PID target value
<b>Range</b>	<b>【0.0~100.0】 %</b>
<b>10- 03</b>	PID control mode
<b>Range</b>	<b>【xxx0b】</b> : PID invalid <b>【xxx1b】</b> : PID valid <b>【xx0xb】</b> : PID positive characteristic <b>【xx1xb】</b> : PID negative characteristic <b>【x0xxb】</b> : PID error value of D control <b>【x1xxb】</b> : PID feedback value of D control <b>【0xxxb】</b> : PID output <b>【1xxxb】</b> : PID output +target value
<b>10- 04</b>	Feedback gain
<b>Range</b>	<b>【0.01~10.00】</b>
<b>10- 05</b>	Proportional gain (P)
<b>Range</b>	<b>【0.00~10.00】</b>
<b>10- 06</b>	Integral time (I)
<b>Range</b>	<b>【0.0~100.0】 Sec</b>
<b>10- 07</b>	Differential time (D)
<b>Range</b>	<b>【0.00~10.00】 Sec</b>
<b>10- 09</b>	PID bias voltage
<b>Range</b>	<b>【-100~100】 %</b>
<b>10- 10</b>	PID Primary delay time
<b>Range</b>	<b>【0.00~10.00】 %</b>
<b>10-14</b>	PID integral limit
<b>Range</b>	<b>【0.0~100.0】 %</b>
<b>10-23</b>	PID limit
<b>Range</b>	<b>【0.00~100.0】 %</b>
<b>10-24</b>	PID output gain
<b>Range</b>	<b>【0.0~25.0】</b>
<b>10-25</b>	PID reversal output selection
<b>Range</b>	<b>【0】</b> : Do not allow the reversal output <b>【1】</b> : Allow the reversal output
<b>10-26</b>	PID target acceleration / deceleration time
<b>Range</b>	<b>【0.0~25.5】 Sec</b>

### **Use PID control**

PID control function, (P) proportional, (I) integral, and (D) differential, play the roles to reduce the deviation between the target command and the actual control value.

#### **PID Control operation**

Characteristics outline of the PID control is as following:

- . P control : A difference (deviation) between the input command (set value) and the actual control value (feedback). This difference or deviation will be amplified by a set gain (P), control and reduce the system deviation. Although the gain is increased, system might still be unstable.
- . I control : This control allows that the relative gain (P) is integrated in time. Therefore, a high gain may be used in results with small deviation. When the integral time (I) is increased, the system response will be reduced.

- . D control : This control has the opposite effect when compared to the result of integral control. The input deviation is differentially controlled in order to increase the system response. Note that this function might easily cause the system is unstable, so it requires careful adjustment.
- . PID control: Combining the best of P, I and D control features enables the system control optimization.

Refer to Figure 4.3.77 for PID control operation

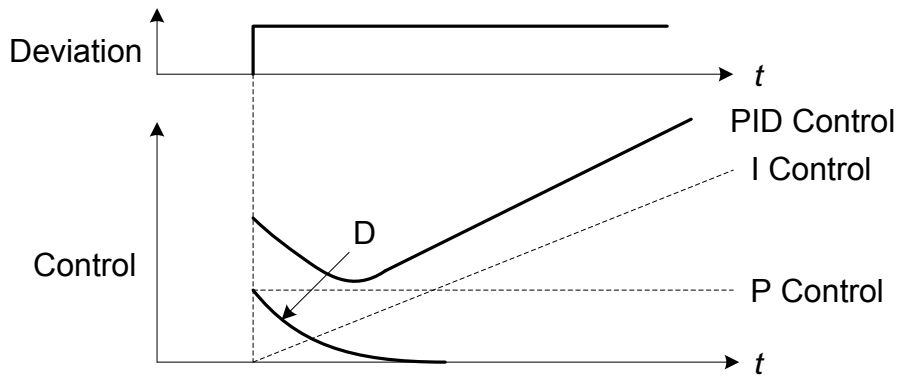

Figure 4.3.77 PID control operation

### **PID control type**

The inverter contains two types of PID control:

- (a) PID control for the feedback value differential: (when 10-03 = x1xxb)

For PID control for the feedback value differential, the feedback value is differential. Different response can be achieved by changing the target value and control procedure. Be more careful to adjust the PID parameters so as to maintain system stable. Refer to Figure 4.3.78 for PID control for feedback value differential.

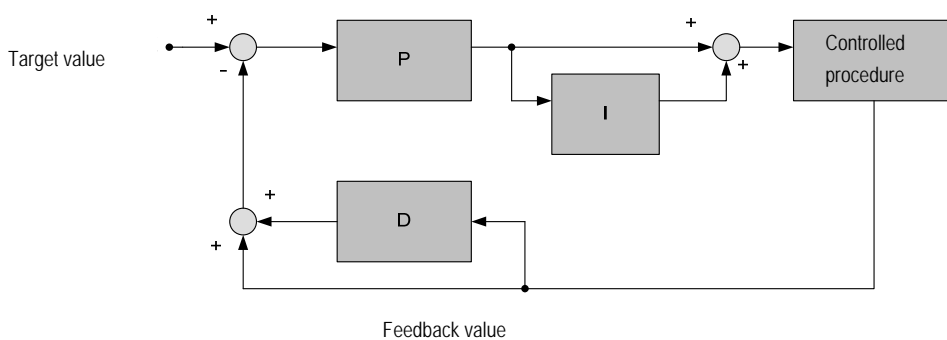
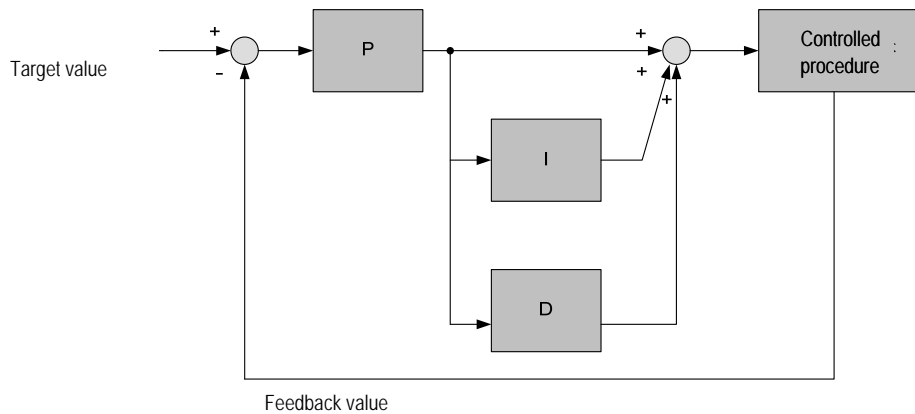

Figure 4.3.78 PID control for feedback differential value

- (b) Basic PID control: (when 10-03 = x0xxb)

This is the basic type of PID control. Refer to the figure 4.3.79 for basic PID control.



**Figure 4.3.79 Basic PID control**

. PID input way:

Enable PID control by using the parameter 10-03 and PID target value (10-00) as well as PID feedback value (10-01).

(1) Input way of PID target value:

. Select the input way of PID target value (10-00), set according the following :

- . 10-00 (00-05=4 is enabled)
  - =1: analog AI1 given (default)
  - =2: analog AI2 given
  - =3: Retain
  - =4:10-02given

(2) Input way of PID feedback value:

. Selection the input way of PID feedback value (10-01):

- . 10-01 = 1 : analog AI1 given
  - = 2 : analog AI2 given
  - = 3 : Retain

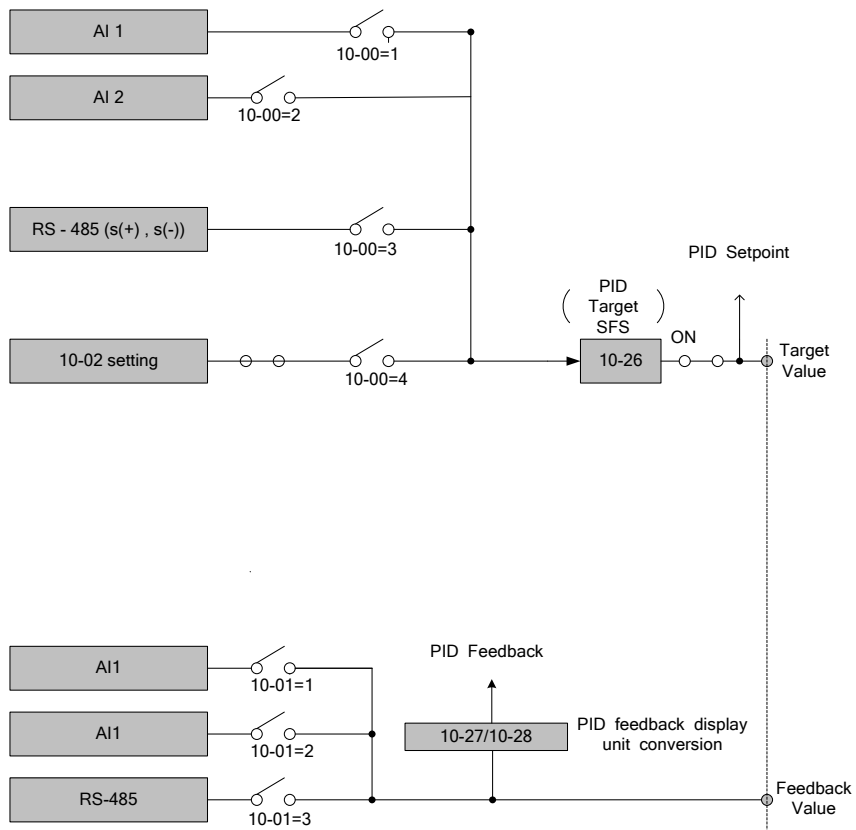

**Figure 4.3.80 PID input way**



## PID control Setting

. PID control block diagram.

The following figure shows the PID control block diagram.

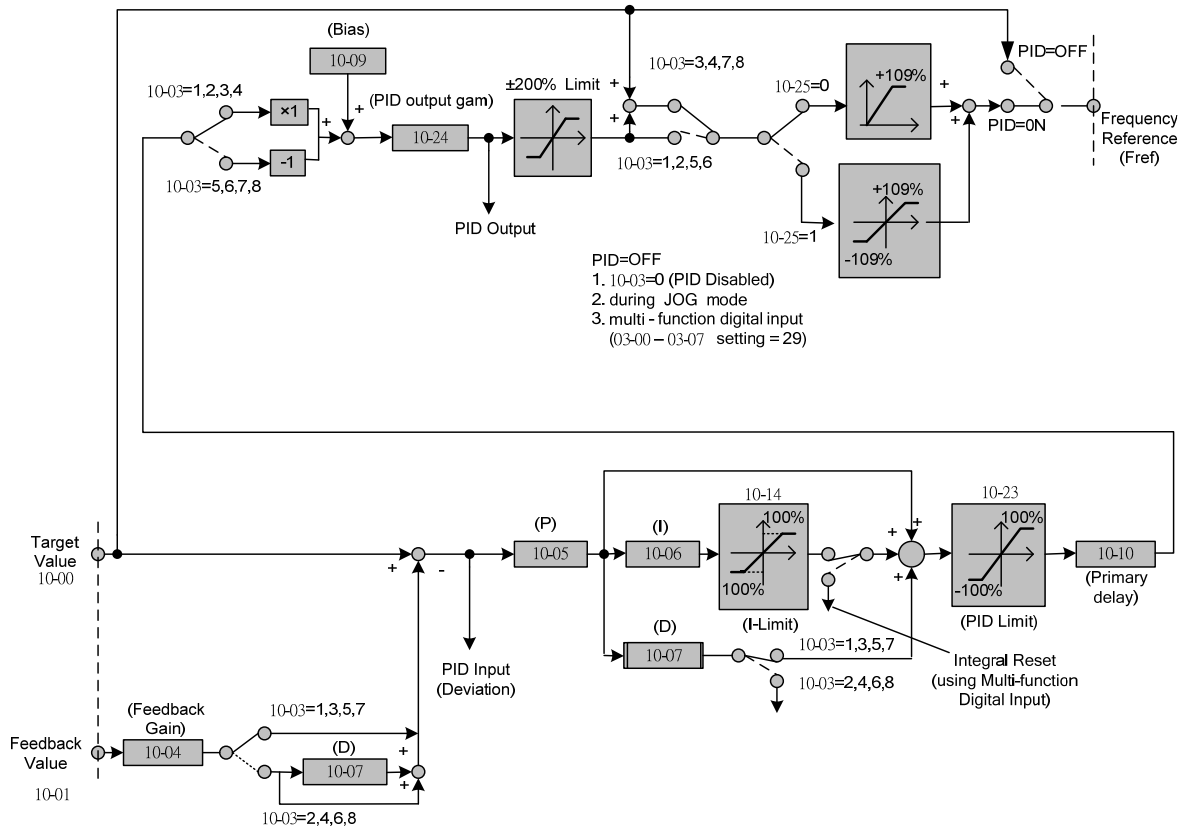

Figure 4.3.81 PID control block diagram

## **PID tuning method**

Use the following procedures to start PID control,

(1) Enable PID control (set 10-03 greater than "xxx0b").

(2) Increase the gain (10-05) as high as possible until the maximum value before oscillation occurs.

(3) Decrease the integral time (10-06) as low as possible until the maximum value before oscillation occurs.

(4) Increase the differential time (10-07) as high as possible until the maximum value before oscillation occurs.

. Proportional (P), integral (I) and differential (D) function provide a usable closed-loop control for system procedure, or adjustment (pressure, temperature, etc.). The adjustment is based on the comparison error signal between the target value and the feedback value.

.PID output polarity can be selected by the 10-03 (setting = xx0xb: PID output forward, setting = xx1xb: PID output reversal). When the PID output is selected as the reversal and if the PID target value increases, the inverter will output low frequency.

. PID feedback value can be adjusted by parameter 10-04 (PID feedback gain), and the feedback analog input gain as well as bias terminal (AI1 or AI2) proportion, gain and bias. In PID control, 10-14 (PID integral limit) is used to avoid the integral value exceeding expectation. When the rapid load change occurs, the machine may be damaged or the motor may be stalled. For these cases, you can reduce the set value of 10-14 to increase the inverter response.

. 10-23 (PID limit) is used to prevent the over value calculated by PID control. The maximum output frequency is in line with 100%.

. 10-10 (low-pass filter time constant of PID control output) is used to avoid the event of the load resonant and rigidity insufficient due to high load resistance. In these cases, you can adjust the time constant greater than the resonance frequency cycle and reduce this set value so as to increase the inverter response. 10-09 (PID bias) is used to adjust the PID control compensation, increasing by the unit of 0.1%.

. If the PID control output is added to the frequency reference as compensation, 10-24 (PID output gain) is used to adjust the amount of compensation.

. When the PID control output is negative, parameter 10-25 (PID reversal output selection) can be used to reverse the inverter. In any event, when the reversal prohibition function is selected, the PID control output limit is 0.

. 10-26 (PID target SFS) sets the PID output increasing and decreasing time to increase or decrease PID target value. The inverter acceleration / deceleration are set by 00-14 ~ 17 to 00-21 ~24. Based on the settings from 00-14 ~ 17 to 00-21 ~24, the PID control will be used in the cases of load resonance or instability occurrence. If these cases occur, you can reduce the acceleration / deceleration time (00-14 ~17 to 00-21 ~ 24) until the system is stable and maintain the necessary acceleration / deceleration time. This function can be disabled by setting the parameter of multi-function digital inputs 03-00 ~ 03-07 to 36 (PID target SFS is off).

## PID fine tuning

. All set parameters of the PID control are related, they need to be adjusted to the appropriate values. Therefore, the procedure achieving the minimum steady-state is shown as following:

(1) Increase or decrease the proportion (P) gain until stability and maintain it in the smallest controlled change.

(2) The additional integral (I) will reduce the system stability which is similar to the time-fold increase of the gain. This time should be adjusted so the highest proportional gain can be used without affecting the system stability. Nevertheless, the increase in time will also reduce the system response.

(3) Adjust the differential time to reduce startup overshoot if necessary. The acceleration / deceleration time of inverter can also be used for this purpose.

. Fine-tuning of PID control parameter is shown as following:

(1) Reduce overshoot

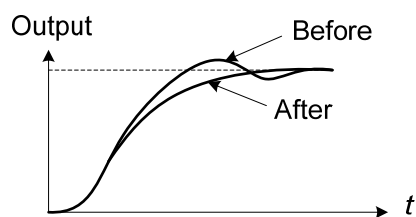

If overshoot occurs, reduce the derivative time (D) and prolong the integral time (I).

(2) Stabilize the control status

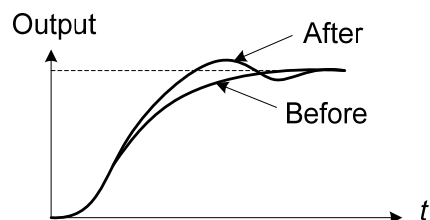

To rapidly stabilize the control, reduce the integral time (I) and prolong the defferential time (D) when the overshoot occurs.

(3) Reduce long-period oscillation

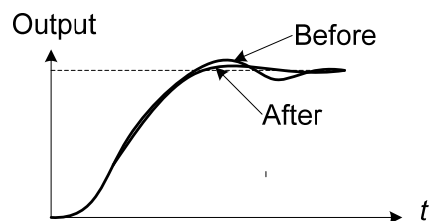

If long periodical oscillation occurs, the periodical oscillation can be effectively improved by adjusting the integral time (I).

(4) Reduce short-period oscillation

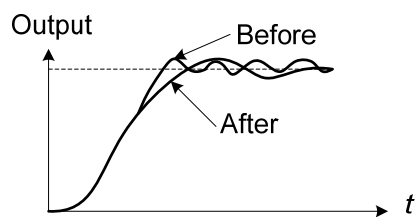

If periodical oscillation is short, improve the periodical oscillation by adjusting the differential time (D) and proportional (P) gain at the same time.

<b>10-11</b>	PID feedback loss detection selection
<b>Range</b>	<b>【0】</b> : Invalid <b>【1】</b> : Warning <b>【2】</b> : Fault
<b>10-12</b>	PID feedback loss detection level
<b>Range</b>	<b>【0~100】 %</b>
<b>10-13</b>	PID feedback loss detection time
<b>Range</b>	<b>【0.0~10.0】 Sec</b>

- . PID control function provides a closed-loop system control. If the PID feedback is lost, the inverter output frequency may be increased to the maximum output frequency. So when the PID control is performed, make sure the PID feedback loss detection is enabled.
- . When 10-11 (PID feedback loss detection option) = 1, and PID feedback value status is less than the set value of 10-12 (PID feedback loss detection level) and more than the set time of 10-13 (PID feedback loss detection time), the PID feedback loss warning message "Pb" will be displayed on the digital operator, and the inverter continues to operate.
- . When 10-11 = 2, the failure message "Fb" of feedback signal loss will be displayed, the failure contact acts and the inverter stops operation.
- . Refer to the figure. 4.3.82 for the operation timing diagram

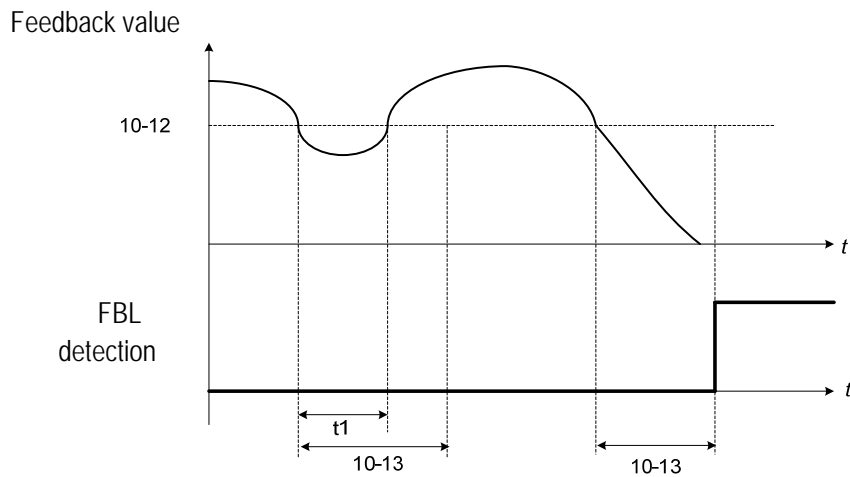
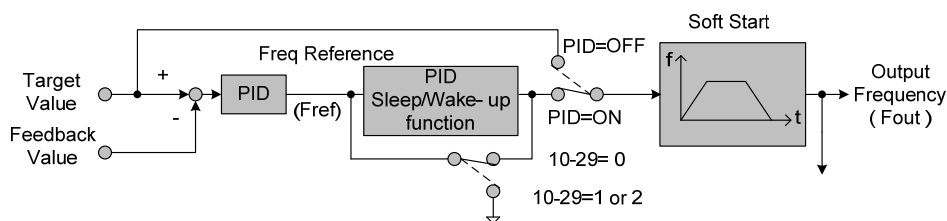

**Figure 4.3.82 PID feedback loss detection**

<b>10-17</b>	Start frequency of PID sleep
<b>Range</b>	<b>【0.00~180.00】 Hz</b>
<b>10-18</b>	Delay time of PID sleep
<b>Range</b>	<b>【0.0~255.5】 Sec</b>

<b>10-19</b>	Frequency of PID waking up
<b>Range</b>	<b>【0.00~180.00】 Hz</b>
<b>10-20</b>	Delay time of PID waking up
<b>Range</b>	<b>【0.0~255.5】 Sec</b>
<b>10-29</b>	PID sleep selection
<b>Range</b>	<b>【0】</b> : invalid <b>【1】</b> : valid <b>【2】</b> : set by DI

- . Based on the energy demand, the PID sleep / waking up function allows the motor automatically starts / stops.
- . Refer to the following figure 4.3.83 for PID sleep / waking up operation.



**(a) PID control block diagram**

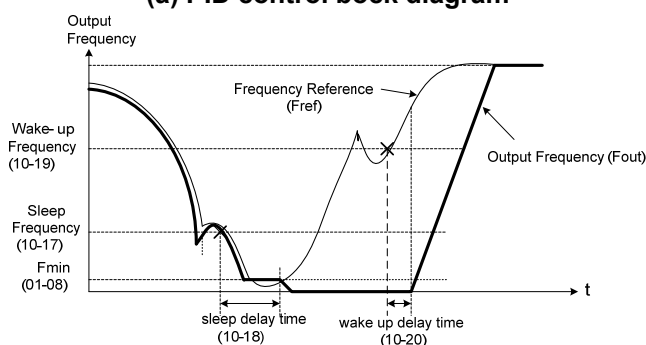

**(b) timing diagram of PID sleep / waking up**

**Figure 4.2.83 PID sleep / waking up operation**

- . When the output frequency ( $F_{out}$ ) is lower than the PID sleep frequency set by 10-17, the timer of PID sleep mode will be enabled, and the output frequency will change according to the reference frequency ( $F_{ref}$ ) until the minimum output frequency ( $F_{min}$ ) set by 01-08 ( $F_{min}$ ) is reached. When 10-18 (delay time of PID sleep) is reached, the motor of inverter will gradually decelerate to stop and the inverter enter the sleep mode.
- . When the inverter enters a sleep mode and the motor stops operation, the PID control is still in operation. When the reference frequency increases and exceeds the waking up frequency set by 10-19, and the delay time set by 10-20 is reached, the motor of inverter will restart and the output frequency will climb to the reference frequency.
- . 10 - 00 and 10--01 can not be set to the same source. If they are set to the same values, the panel will display the PID selection's error message of "SE05".

- . Use parameter 10-29 to enable / disable PID sleep function.
  - 10-29 = 0: PID Sleep function (sleep mode ) is disabled.
  - = 1: PID sleep operation is based on parameters of 10-17 and 10-18, as described above.
  - = 2: PID sleep mode is enabled by multi-function digital input

<b>10-27</b>	PID Feedback Display Bias
<b>Range</b>	<b>【-99.99~99.99】</b>
<b>10-28</b>	PID Feedback Display Gain
<b>Range</b>	<b>【0.00~99.99】</b>

- . PID feedback value can be monitored by parameter. The display unit can be set by 10-27 (PID feedback display bias) and 10-28 (PID Feedback Display gain).
- . For example, the feedback value of 0 - 10V or 4 - 20mA will be displayed as pressure. Use 10-27 to set the pressure unit (PSI unit) to 0V or 4mA feedback signal and use 10-28 to set the pressure value corresponding to 10V or 20mA. Refer to the figure 4.3.84 for displaying the unit conversion.

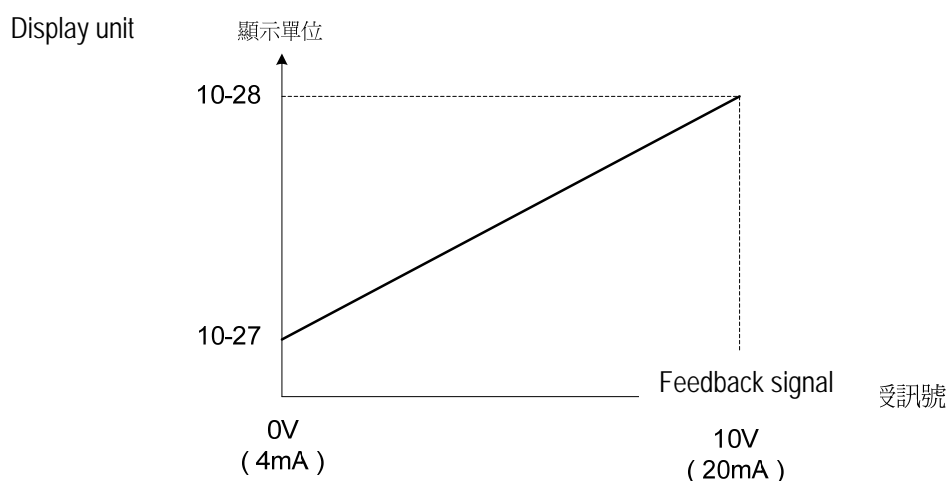

**Figure 4.3.84 Display the unit conversion**

**Example :** feedback signal: 0V = 0% = 1.0 PSI  
 10V = 100% = 20.0 PSI  
 Parameter Setting : 10-27 = 1.0 (0% feedback value )  
 10-28 = 20.0 (100% feedback value )

## 11-Auxiliary Function Group

<b>11- 00</b>	Direction Lock Selection
<b>Range</b>	<b>【0】</b> : Allow forward and reverse rotation <b>【1】</b> : Only allow forward rotation <b>【2】</b> : Only allow reverse rotation

- . If the motor operation direction is set to 1 or 2, then the motor can only operate according to the specified direction rather than accepting the operation command for opposite rotation.
- . Forward or reversal command can be controlled by the control terminal, LED digital control panel.
- . This parameter can be used to the pump and fan of the reversal motor.

<b>11- 01</b>	Carrier frequency
<b>Range</b>	<b>【0】</b> : carrier output frequency tuning <b>【1】</b> : Retain <b>【2~16】 KHz</b>

- ① when 11-01= 2 to 16, carrier frequency of PWM output is in KHz.
- ② when 11-01=0, it allows setting detail through 11-30~11-32
- ③ For SLV and SV mode, the minimum value of 11-01 is set to 4
- ④ Setting range is determined by the inverter capacity 13-00 and HD/NDmode (00-27).

For low-carrier, the motor noise increases, but the noise generated by RFI and EMI decreases, and the leakage current reduces. Please refer to the carrier frequency impacts shown in Table 4.3.14.

**Table 4.3.14 Carrier frequency impacts**

Carrier frequency (11-01=2 to 16))	2KHz--6K--10K--16KHz	
Motor noise	big -----	small
waveform of the output current	bad---good-----	bad
Interface noise	small-----	big
Lakage current	low-----	high

- Setting range and factory setting are depended on the capacity of the inverter. Please refer to section 3 for the basic specification of factory setting and the maximum optional parameter limit of this parameter.
- The inverter with lower capacity can use relative high carrier frequency. Please refer to section 3 for lowering the rated curve.
- Lowering set value can reduce motor losses and motor temperature; on the contrary, it will increase motor losses and motor temperature.
- If the wire between the inverter and the motor is too long, the high-frequency leakage current will cause the increase of inverter output current, which might affect the peripheral device. To avoid this situation, adjust the carrier frequency shown in table 4.3.15.

**Table 4.3.15 Wire length and carrier frequency**

Wire length	< 30 Meter	30 Meter – 50 Meter	50 Meter -100 Meter	> 100 Meter
Carrier frequency (11-01 Setting value )	Maximum value 16KHz (11-01=14KHz)	Maximum value 10KHz (11-01=10KHz)	Maximum value 5KHz (11-01=5KHz)	Maximum value 2KHz (11-01=2KHz)

- If the torque does not match the speed, please reduce the carrier frequency.
- When the V / F and V / F + PG control modes are used, the carrier frequency will be determined by parameters set by 11-30 (the maximum limit of the carrier frequency), 11-31 (the lowest limit of the carrier frequency) and 11-32 (proportional gain of the carrier frequency ) and so on.

<b>11- 02</b>	Soft PWM Function Selection
<b>Range</b>	<b>【0】</b> : Invalid <b>【1】</b> : Valid

Set 11-02 = 1 to enable Soft-PWM control so as to improve the quality of the motor noise. The Soft-PWM control can improve the metal noise produced by the motor, making the ear more comfortable. At the same time, it also limits RFI noise to the minimum level. The default setting of Soft-PWM control is disabled. When Soft-PWM is enabled, the maximum carrier frequency is limited to 8KHz.

<b>11- 03</b>	Automatic carrier lowering selection
<b>Range</b>	<b>【0】</b> : Invalid <b>【1】</b> : Valid

If the internal protection of the inverter detects over-heat temperature, this carrier frequency will automatically lower down until the temperature returns to normal situation. The carrier frequency will automatically return to the set value of (11-01).

(1). 11-03=0

Automatic change function of the carrier frequency is invalid. The carrier frequency operation is determined by 11-01 setting.

(2). 11-03=1

Automatic change function of the carrier frequency is valid. When the heat sink is over heated, the inverter will automatically reduce the carrier frequency (see section 3, the law for lowering rated parameter).

<b>11- 04</b>	S curve time setting at the start of acceleration
<b>11- 05</b>	S curve time setting at the end of acceleration
<b>11- 06</b>	S curve time time setting at the start of deceleration
<b>11- 07</b>	S curve time setting at the end of deceleration
<b>Range</b>	<b>【0.00~2.50】 Sec</b>

Using S curve characteristics for acceleration / deceleration can reduce the mechanical impact caused by the load at the moment of stop or start. For A510 inverter, you can set the S curve time for acceleration start point (11-04), acceleration end point (11-05), deceleration start point (11-06) and deceleration end point (11-07) independently. The relationship between parameters is shown in Figure 4.3.85.

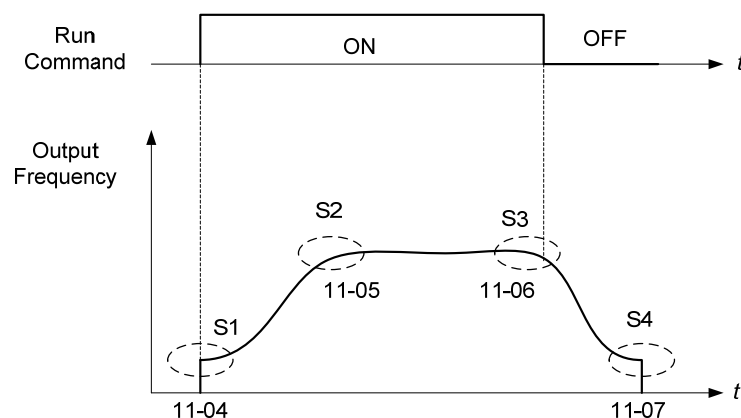

Figure 4.3.85 S curve characteristic

. After setting S curve time, the characteristics of acceleration and deceleration are shown as following:

. Acceleratin time =Acceleratin time 1 (or 2) +  $\frac{(11-04) + (11-05)}{2}$

. Deceleratin time =Deceleratin time 1 (or 2) +  $\frac{(11-06) + (11-07)}{2}$



<b>11-08</b>	Jump frequency 1
<b>11-09</b>	Jump frequency 2
<b>11-10</b>	Jump frequency 3
<b>Range</b>	<b>【0.0~400.0】 Hz</b> <b>【0.0~1200.0】 Hz</b> (when 00-31 = 1)
<b>11-11</b>	Jump frequency width
<b>Range</b>	<b>【0.0~25.5】 Hz</b>

- . These settings allow the "jump" of the specific frequency within the range of inverter output frequency, so that the motor operates without any influence of the mechanical system.
- . Prohibit any operation in the range of jump frequency, but the frequency increasing/decreasing in the period of acceleration and deceleration is continuous, without jump.
- . Set the jump point 1 - 3 (11-08 to 11-10) of the frequency to 0.0Hz, this function can be removed.
- . As to jump point 1 - 3 (11-08 to 11-10) of the frequency, the intermediate frequency can be set to jump.
- . As to 11-11, set the width of the frequency jump. Jump frequency  $\pm$  frequency jump width will form the range of frequency jump.
- . The relationship of the output frequency and the jump frequency is shown in Figure 4.3.86.

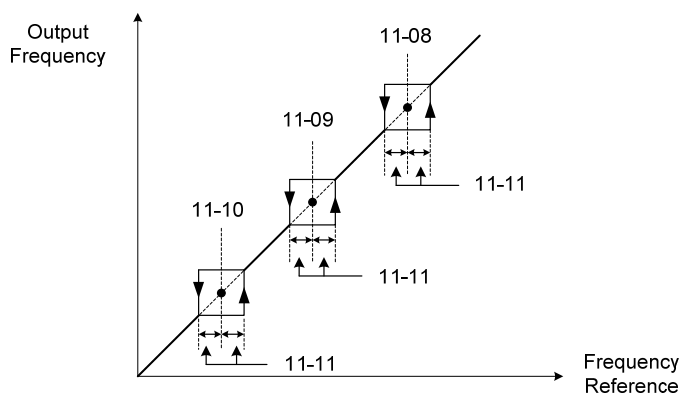

**Figure 4.3.86 Jump frequency operation**

- . When setting 04-05 (AI2 function selection of multi-function analog input) to 9 (frequency jump setting 4), you can set the fourth frequency jump point. For the setting operation of frequency jump, refer to Figure 4.3.48.
- . When the set jump speeds overlap each other, their sum will be regarded as the jump range, please refer to the following figure 4.3.87.

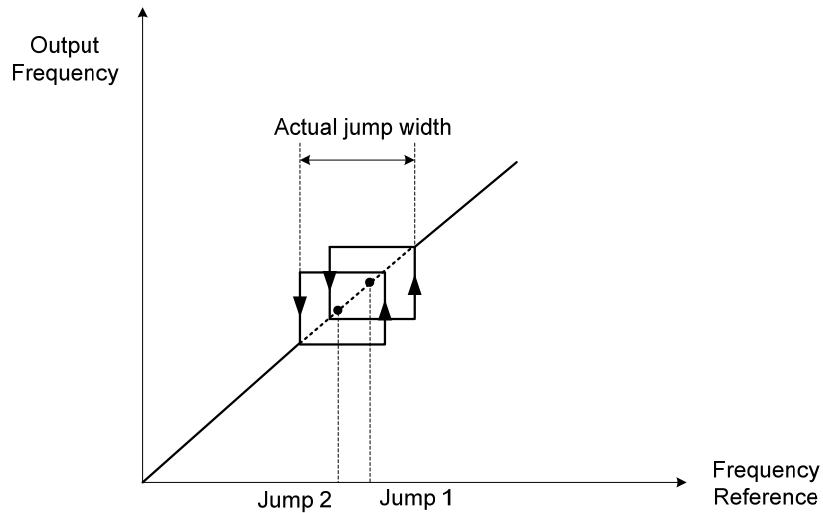

**Figure 4.3.87 Jump frequency overlap**

<b>11- 12</b>	Manual energy saving gain
<b>Range</b>	<b>【0~100】 %</b>
<b>11- 18</b>	Manual energy saving frequency
<b>Range</b>	<b>【0.00~400.00】 Hz</b> <b>【0.0~1200.0】 Hz (when 00-31 = 1)</b>

. When the command of manual energy saving has been set by multi-function digital input (03-00 to 03-07 = 20), the manual energy saving (MES) control function is enabled.

. When the light load is used, the inverter will reduce the output voltage for the purpose of saving energy. Therefore, when the normal load is used, please turn off the manual energy saving command.

(1) Manual energy saving gain (11-12).

. When the manual energy saving command is input, the parameter of 11-12 will determine the output voltage of inverter.

Take the percentage of V/F voltage as setting value.

. When the manual energy saving control is enabled or disabled, the voltage recovery time (07-23) will be determined by the change proportion of the output voltage

(2) Manual energy saving frequency (11-18)

. When the reference frequency is greater than 11-18 and the motor speed is within the allowable range, the command of manual energy saving is enabled. Refer to the figure 4.3.88 for manual energy saving operation.

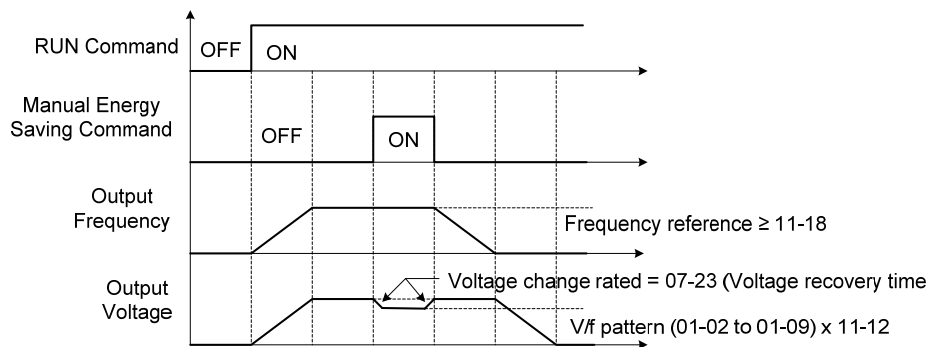

**Figure 4.3.88 Manual energy saving operation**

<b>11- 19</b>	<b>Automatic energy saving function</b>
<b>Range</b>	<b>【0】</b> : Automatic energy saving is invalid <b>【1】</b> : Automatic energy saving is valid
<b>11- 20</b>	<b>Filter time of automatic energy saving</b>
<b>Range</b>	<b>【0~200】 mSec</b>
<b>11- 21</b>	Voltage upper limit of energy saving tuning
<b>Range</b>	<b>【0~100】 %</b>
<b>11- 22</b>	<b>Adjustment time of automatic energy saving</b>
<b>Range</b>	<b>【0~5000】 mSec</b>
<b>11- 23</b>	<b>Detection level of automatic energy saving</b>
<b>Range</b>	<b>【0~100】 %</b>
<b>11- 24</b>	<b>Coefficient of automatic energy saving</b>
<b>Range</b>	<b>【0.00~655.35】</b>

. In the V / F control mode, the automatic energy saving (AES) function automatically adjusts the optimum output voltage, and reduces the output current of the inverter according to the load. The output power changes according to the load proportion. When the load proportion exceeds 70%, energy saving is the least, but when the load becomes lighter, energy saving will increase.

. The parameter of automatic energy saving function has been set at the factory before shipment. In general, it is no need to adjust. If the motor characteristic has significant difference from TECO standard, please refer to the following commands for adjusting parameters:

(1) Control mode of automatic energy saving function (11-19)

. Automatic energy saving function is enabled, set 11-19 to 1.

(2) Filter time of automatic energy saving (11-20)

(3) Commissioning parameter of energy saving (11-21 to 11-22)

. In AES control mode, the optimum voltage value is calculated from the load power requirement, but this calculated value will change with the differences of the temperature and motor characteristic. Therefore, the optimum voltage should be adjusted based on some cases. In order to obtain the best voltage value, you can set the following AES parameters for commissioning:

a. Voltage limit value of AES commissioning operation (11-21)

. Set the voltage limit range in commissioning.

.Set corresponding ranges for model of 220V and model of 440V respectively (100% corresponding to 220V or 440V)

Close the commissioning operation.

. Refer to the figure 4.3.89.

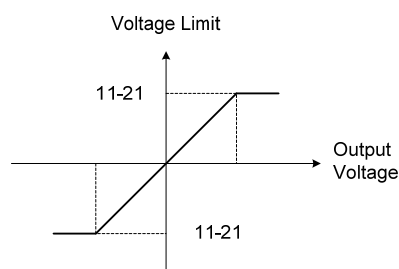

**Figure 4.3.89 Voltage limit value of commissioning operation**

- b. Cycle time of AES commissioning operation controlling (11-22)
  - . Set the time constant based on the detection output power.
  - . Reduce the setting of 11-22 to increase response when the load is changed.
  - . When the load becomes lighter, if the set value of 11-22 is too low, the motor may become unstable.

(4) Energy saving detection level (11-23)

(5) Energy saving detection factor (11-24).

- . This factor can be used to calculate the calculated value of the motor at maximum efficiency, and the calculated value is the voltage reference.
- . The factory sets 11-24 based on the corresponding relationship between the motor and the inverter. If the motor capacity is different, please set the parameter of motor capacity 13-00 (Motor rated power output) and adjust the output voltage of 11-24, until the minimum value reached.
- . Greater energy saving factor 11-24 generates greater output voltage.

<b>11- 29</b>	Auto De-rating Selection
<b>Range</b>	<b>【0】</b> : Invalid <b>【1】</b> : Valid

If the inverter inner detects too high temperature, and when the automatic carrier frequency change function has not been enabled (11-03 = 0), or the automatic carrier frequency change function is enabled but the carrier frequency of the inverter is reduced to the lowest carrier frequency, the output frequency of the inverter will automatically drop by 30% of the rated speed.

- (1) 11-29=0: If auto de-rating selection is not enabled, the carrier frequency will be based on 11-01 or 11-03.
- (2) 11-29=1: auto de-rating selection is enabled, when the temperation of the heat sink is too high, the output frequency of the inverter will automatically drop by 30% of the rated speed.

<b>11- 30</b>	Variable Carrier Frequency Max. Limit
<b>Range</b>	<b>【2~16】 KHz</b>
<b>11- 31</b>	Variable Carrier Frequency Min. Limit
<b>Range</b>	<b>【2~16】 KHz</b>
<b>11- 32</b>	Variable Carrier Frequency Proportional Gain
<b>Range</b>	<b>【00~99】</b>

- . The characteristics of carrier frequency will be different because of the control methods.
  - ① V / F and V / F + PG control mode: You can use 11-01 = 2~ 16 for the fixed carrier frequency, or 11-01 = 0 for any changeable carrier.
  - ② SLV and SV control mode : there is only the fixed carrier frequency (11-01=2~16)
    - . In V/F and V/F+PG control mode, the carrier frequency can be changed according to 11-30 ~ 11-32 settings.

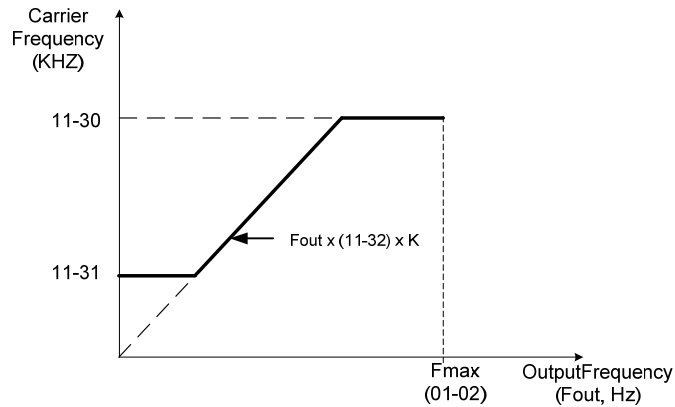

Here, K as a coefficient, its value is based on the following description (maximum carrier frequency):

- ① K=1: when 11-30 < 5 KHz
- ② K=2: when 10 KHz > 11-30 ≥ 5 KHz
- ③ K=3: when 11-30 ≥ 10KHz

- . As noted above, if the speed and torque are consistent in V / F and V / F + PG control mode, the output frequency and carrier frequency variable (K) can be selected to reduce the carrier frequency.
- . The fixed carrier frequency, becomes zero at 11-30, 11-31, or 11-32.
- . If the carrier frequency proportional gain (11-32) > 6 and 11-30 < 11-31, the error message "SE01" of range setting will appear.
- . If the minimum limit (11-31) is set higher than the maximum limit (11-30), the minimum limit will be ignored and the carrier frequency will be set at the highest limit (11-30).
- . In SLV and SV control mode, the maximum limit of the carrier frequency is fixed at 11-30.

<b>11- 33</b>	DC Voltage Filter Rise Amount
<b>Range</b>	<b>【0.00~1.00】 V</b>
<b>11- 34</b>	DC Voltage Filter Fall Amount
<b>Range</b>	<b>【0.00~1.00】 V</b>
<b>11- 35</b>	DC Voltage Filter Deadband Level
<b>Range</b>	<b>【0.0~99.0】 V</b>
<b>11- 36</b>	Frequency gain of OV prevention
<b>Range</b>	<b>【0.000~1.000】</b>
<b>11- 37</b>	Frequency limit of OV prevention
<b>Range</b>	<b>【0.00~10.00】 Hz</b>
<b>11- 38</b>	Deceleration start voltage of OV prevention
<b>Range</b>	<b>【200~400】 V : 220V</b> <b>【400~800】 V : 440V</b>
<b>11- 39</b>	Deceleration end voltage of OV prevention
<b>Range</b>	<b>【300~600】 V : 220V</b> <b>【600~1200】 V : 440V</b>
<b>11- 40</b>	OV prevention selection
<b>Range</b>	<b>【0】 : Invalid</b> <b>【1】 : Valid</b>

Over-voltage prevention can be used to the applications that easily cause the energy recharge the inverter.

Example: In punching application, there are two cases that overabundance energy recharge the inverter.

- (1) Before the convergence of the cam clutch, the motor will accelerate and start the flywheel. When the motor decelerates, the flywheel speed will exceed the motor speed because of its big inertia, causing the energy recharges the inverter.
- (2). When the cam clutch is convergent, the motor will start the flywheel and compress the spring. When the highest point of the cam exceeds the cam center, the spring will release the power to the flywheel, causing too much energy recharge the inverter.

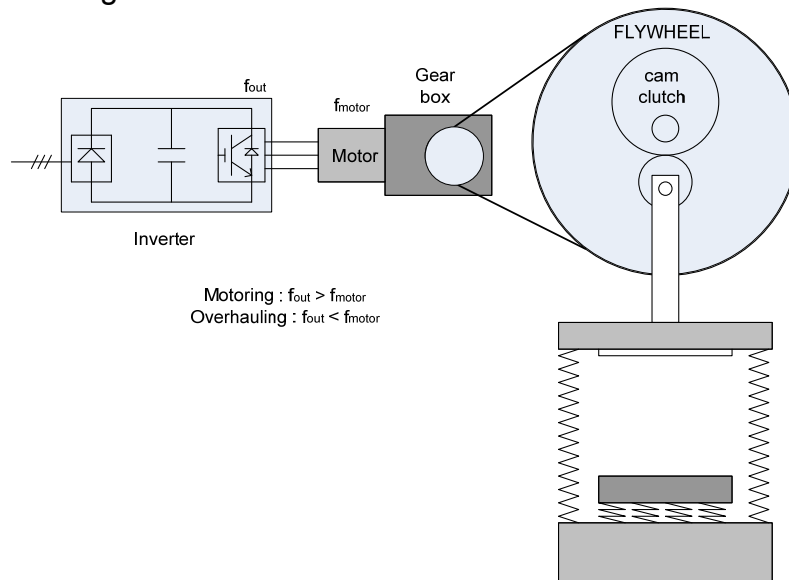

**Figure 4.3.90 Punching operation**

- . Over-voltage prevention (OVP) function can be monitored and adjusted by adjusting the acceleration / deceleration rate, which further changes the recovery energy. When the speed reference is reduced, the motor will start to deceleration. Furthermore, when the frequency is fixed and the recovered energy is detected, the inverter will accelerate the motor in order to reduce the recovered voltage.
- . About the over-voltage prevention (OVP) operation, refer to the following figure 4.3.91.

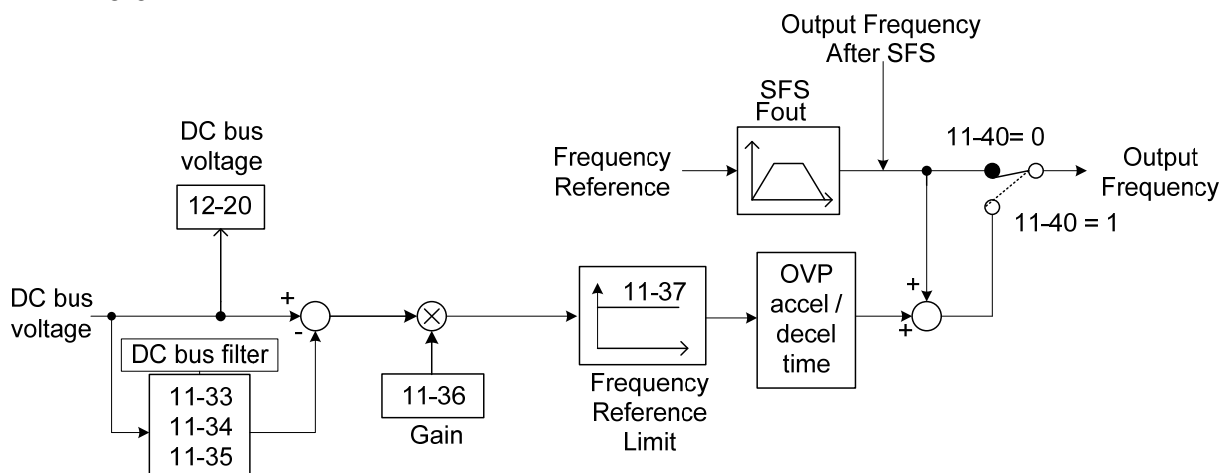

**Figure 4.3.91 OVP operation**

- 1). DC voltage filter is used to provide a stable reference value for determining the amount of DC voltage change when the energy regenerates.
  - . Adjust the DC voltage filtering rate by 11-33 (DC Voltage Filter Rise Amount). When the DC voltage exceeds 11-33 + 11-35 (DC Voltage Filter Deadband Level), the filter output will increase.
  - . Adjust the DC voltage filtering decrease rate by 11-34 (DC Voltage Filter Fall Amount). When the DC voltage exceeds 11-33 + 11-35 (DC Voltage Filter Deadband Level), the filter output will decrease.
  - . Monitor the DC voltage filter output by 12-20 (DC voltage filter value)
  - . Set the decrease rate of DC voltage filter faster than the establishment rate, for example, set the value of 11-34 higher than that of 11-33.
- 2). When the inverter is in operation and the frequency reference is fixed, OVP function will monitor the excessive high voltage of DC voltage.
  - . Multiply the excessive high voltage of DC voltage and 11-36 (OVP frequency reference increment), and convert it into a frequency so that the inverter will accelerate to suppress the recovery energy.
  - . When the recovery energy decreases, the inverter output will return to the input frequency reference, and the deceleration rate is determined according to the DC voltage, as shown in Figure 4.3.92.

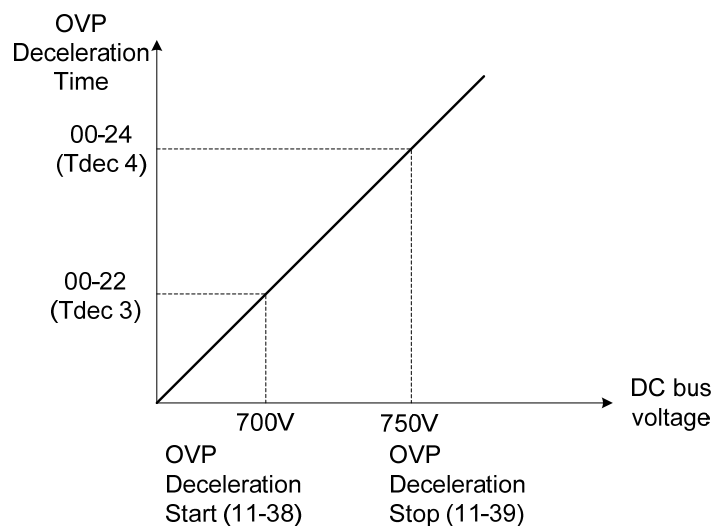

**Figure 4.3.92 OVP Deceleration time**

- 3). When the inverter is stopped, the deceleration rate can be set by 00-15 (Tdec1). When the DC voltage is too high, the inverter will slow down and perform operation based on the OVP deceleration time in Figure 4.3.92.
  - . Set DC voltage in 11-38 (start voltage of OVP deceleration) and set OVP deceleration rate in 00-22 (Tdec3).
  - . When the DC voltage rises to this level, it is necessary to immediately decelerate rapidly in order to prevent that the DC voltage change is too large.
  - . When DC voltage reaches the setting of 11-39 (stop voltage of OVP deceleration), it will decelerate based on the set value of 00-24 (Tdec4)
  - . Deceleration rate will linearly change according to the slope line defined by the start point (11-38) and stop points (11-39).
- 4). Disable or perform OVP function through 11-40. If the OVP function (11-40 = 1) is enabled, the following parameters will be changed to the new default values:
  - 07-12=1 (Stop mode: coast to stop)
  - 00-14(Tacc1)= 5.0 Sec(the frequency reference acceleration rate when DC voltage is too high.)
  - 00-22(Tdec3)= 20.0 Sec(low setting point of OVP deceleration rate).

00-24(Tdec4)= 100.0 Sec(high setting point of OVP deceleration rate).

11-04 = 0.0 Sec  
 11-05 = 0.0 Sec  
 11-06 = 0.0 Sec  
 11-07= 0.0 Sec } (S curve of OVP function should be disabled.)

<b>11- 41</b>	Selection of detecting the disappearance of reference frequency
<b>Range</b>	<b>【0】</b> : when referency frequency disappears, the deceleration will stop. <b>【1】</b> : when referency frequency disappears, continue to operate according to the proportion of referency frequency x 11-42.
<b>11- 42</b>	Disappearance level of referency frequency
<b>Range</b>	<b>【0.0~100.0】 %</b>

.When the master speed frequency command drops 90% or more but less than 400ms, then the referency frequency will be regarded as loss.

.when set 11-41 to 1, the frequency command value of the master current speed is continuously compared to the value previously occurred at 400ms. If the frequency command is confirmed to be broken, the inverter will estimate the current frequency command based on the following formula for operation.

$$\text{Referency frequency } F_{ref} = 11-42 \times \text{reference frequency at loss moment}$$

. In the following case, it shows the operation from the frequency command is loss to the inverter returns to normal situation.

- (1). Input the frequency exceeding 80% under the master frequency command.
- (2). Input stop command

. For the frequency command loss operation, please refer to the following Figure 4.3.93

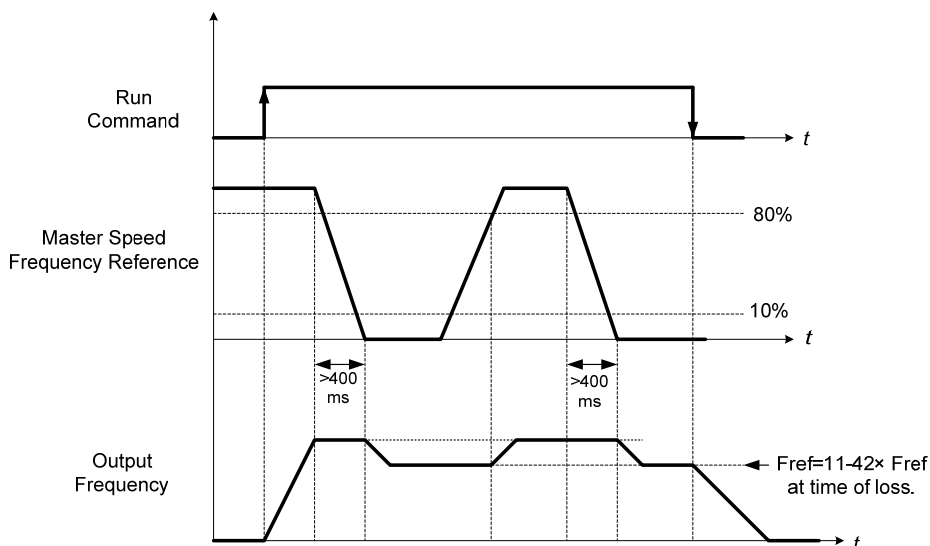
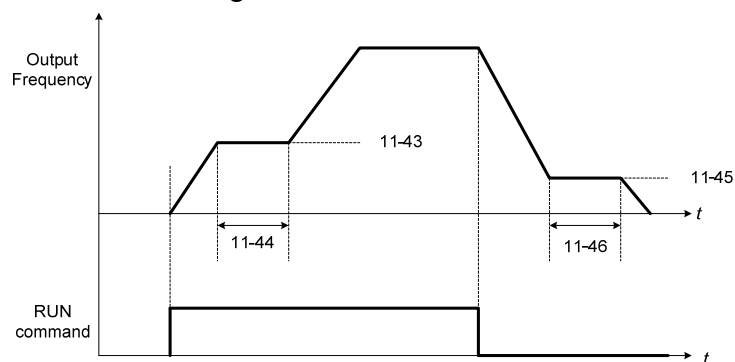

Figure 4.3.93 Frequency reference loss operation



<b>11- 43</b>	Hold frequency at start
<b>Range</b>	<b>【0.0~400.0】 Hz</b>
<b>11- 44</b>	Frequency hold time at start
<b>Range</b>	<b>【0.0~10.0】 Sec</b>
<b>11- 45</b>	Hold frequency at stop
<b>Range</b>	<b>【0.0~400.0】 Hz</b>
<b>11- 46</b>	Frequency hold time at stop
<b>Range</b>	<b>【0.0~10.0】 Sec</b>

- . Retaining function is used to temporarily Retain the reference frequency in order to prevent the inverter stall at starting or stopping operation due to the load.
- . The inverter will drive the motor to run based on the Retaining time of 11-44 (in order to establish magnetic flux) and the start frequency of 11-43.
- . The acceleration of deceleration time does not include the start and stop of the Retaining time. Refer to the figure 4.3.94.



**Figure 4.3.94 Retaining function**

- . In the case of the presence of large inertia load, the Retaining function can be used to reduce the over-current in acceleration.
- . When the inverter is in stop mode, this function can also be used to prevent windmill wearing. In addition, it can be used to save the output frequency and extend the voltage consumption of the inverter, so that the motor can be stopped successfully. You can also refer to the DC brake parameters in 07-16 when it is started.
- . If the frequency of 11-43 is maintained at start and the frequency's set value of 11-45 is maintained to be less than Fmin (01-08) at stop, then the Retaining function is invalid.

<b>11- 47</b>	KEB Deceleratin time
<b>Range</b>	<b>【0.0~25.5】 Sec</b>
<b>11- 48</b>	KEB detection level
<b>Range</b>	<b>【190~210】 V : 220V</b> <b>【380~420】 V : 440V</b>

- . In order to prevent the inverter in the operation at low voltage due to the momentary power failure or power supply breakdown, in a long period that the motor is gliding, it appears immediately when this detector detects an momentary power failure or power supply breakdown, and uses the recovery energy to make the motor decelerate to stop.
- (1) KEB eceleratin time (11-47)
- . If the 11-47 is set to 0.0 , KEB will be turned off.
  - . Set 11-47, KEB deceleratin time from 0.0 to 25.5

(2)KEB detection level (11-48)

- If 11-47 is not set to 0.0, KEB function will be enabled. When DC voltage is lower than the set value of 11-48, the KEB function will start decelerating according to 11-47. Until the DC voltage is higher than 11-48 +10 V (220V series +10 V, 440V Series +20 V), the digital input command (03-00 to 03-07) will make the driver re-accelerate to the original frequency. Refer to the example in Figure 4.3.95.

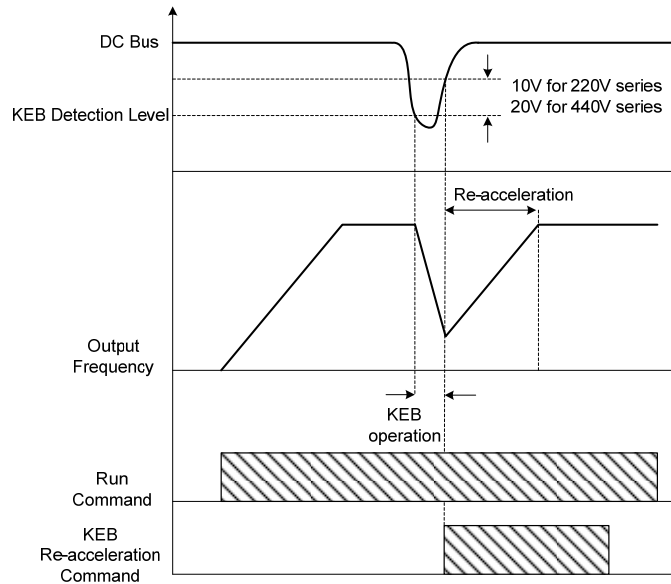

Figure 4.3.95 KEB operation

<b>11- 49</b>	Zero-servo gain
<b>Range</b>	【0~50】
<b>11- 50</b>	Zero-servo count
<b>Range</b>	【0~4096】
<b>11- 51</b>	Braking selection of zero-speed
<b>Range</b>	【0】 : Zero-speed DC braking is invalid 【1】 : Zero-speed DC braking is valid

- . When the motor is stopped, the zero-servo function is used to maintain the motor shaft position.
- . Refer to the figure 4.3.96 for zero servo operation.

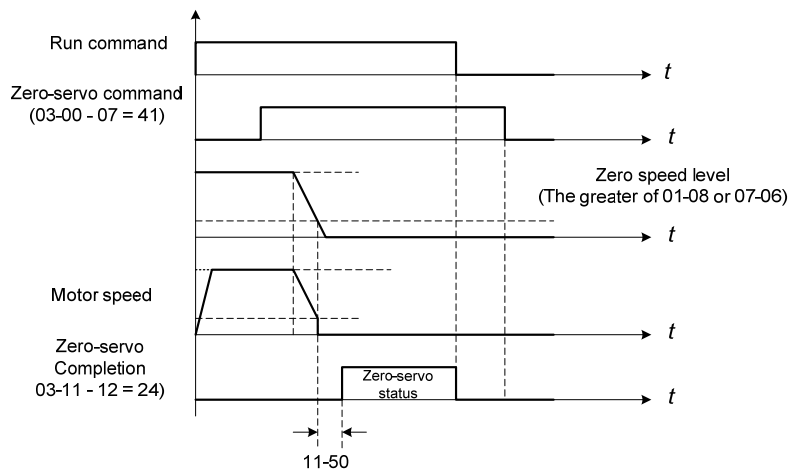

Figure 4.3.96 Zero servo operation

- . Use one of multi-function digital inputs (03-00 to 03-07 = 46 to execute the zero-servo command.
- . When the frequency reference is lower than the zero speed level (the greater one of 01-08 or 07-06 (DC braking start frequency)), the zero servo starts executing (zero servo start position), and the motor shaft position will be remained even if the analog reference signal input is not zero.
- . If the command is disabled in the operation period of zero-servo status, the zero-servo function will become invalid.
- . Use multi-function digital outputs (03-11, 03-12 = 31) to perform zero-servo.
  - When one of multi-function digital outputs is set to 31 (the completion signal of zero-servo), zero-servo count 11-50 will be enabled.
  - DC motor rotor position is in the starting position of zero  $\pm$  servo counts 11-50, the zero-servo completion signal acts.
  - When the zero-servo completion signal is turned off, zero-servo or operation command will be turned on.

#### (1) Zero-servo gain setting (11-49 )

- . Use the zero-servo gain of 11-49 parameter to adjust the Retained torque of zero servo operation.
- . If the set value is increased, the Retained torque will increase and the instability may occur.
- . Do not use the zero-servo function at 100% of the inverter rated current, otherwise it may cause malfunction OH1 (Heatsink overheating). Long time zero-servo Retained torque can maintain 50 to 60% of the inverter rated current through the output current, or increase the inverter capacity.

#### (2) Zero-servo count (11-50)

- . Zero servo count is set to allow the position offset of zero-servo position start.
- . Set the zero servo count 11-50 to 4 times of PG pulse number (considering the rising edge and falling edge of phase A and phase B, calculate 4 times of PG solution).

#### (3) Operation selection of zero-speed braking (11-51).

- . In V / F control mode, the DC braking operation (without PG feedback) can be used to produce the Retained torque.
- . Set 11-51 to select zero-speed braking operation.
  - 11-51=0: Disabled;
  - =1: Enabled

Setting 00-02 (operation command selection) to 1 and 00-05 (frequency reference selection) to 1, the operation command and frequency reference will be input by the control terminal. When the frequency reference is 0V (or less than 4mA), and the operation command is turned on, the zero-speed braking operation will be enabled (11-51 = 1) and the Retained torque will be generated in DC braking mode.

- . Refer to Figure 4.3.97 for details of the zero-speed braking operation. DC braking 07-07 will be limited to 20% of inverter rated current.

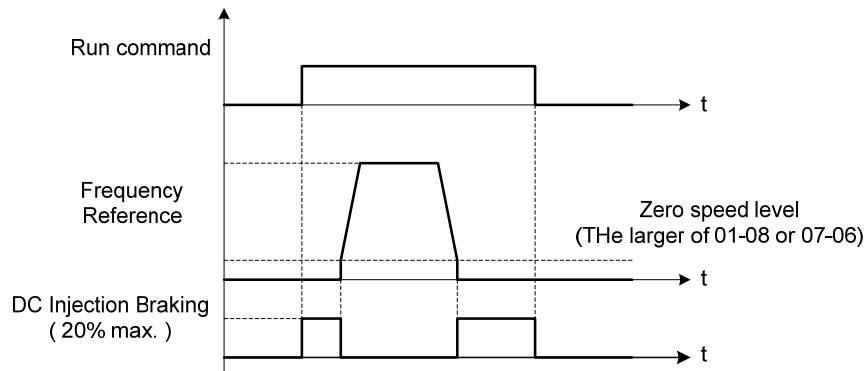
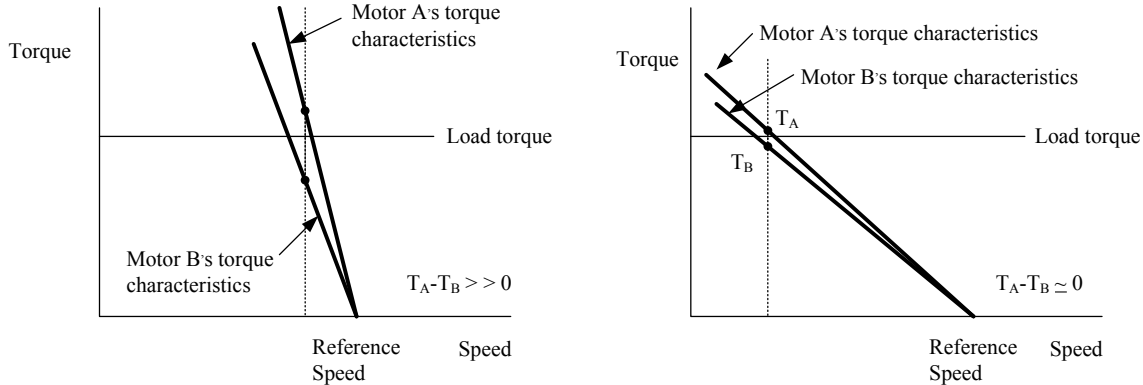

Figure 4.3.97 Zero-speed braking operation

<b>11- 52</b>	Droop control level
<b>Range</b>	<b>【0.01~2.00】</b>
<b>11- 53</b>	Droop control delay
<b>Range</b>	<b>【0.00~2.00】 Sec</b>

- If a load is driven by two motors (e.g, the applications of crane or conveyor), high slippage motors will be used generally to achieve load balancing effect. If the droop function is adopted, the generic motors can be used to obtain the similar effect of high slip motors. The droop function can also ease the torque generated by using two motors to drive a load.
  - (a) is the load balancing case using the generic motors.  
The load torque of motor A,  $T_A >$  The load torque of motor B,  $T_B$ .
  - (b) is the load balancing case using the high slippage motors.  
The load torque of motor A,  $T_A$  is close to the load torque of motor B,  $T_B$ .



(a)  $T_A > T_B$

(b)  $T_A \cong T_B$

- Droop function can be approximate to the characteristic of slippage motor. Set 11-52 to the percentage of the speed reduction amount at 100% of motor torque to the maximum frequency (01-02).
- If 11-52 is set to 0.0%, the droop function is invalid.

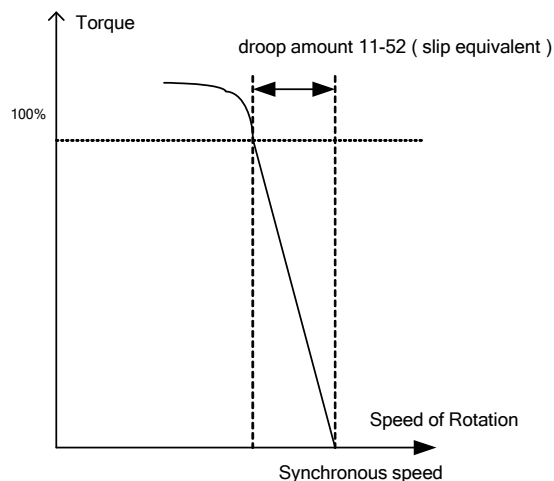

- 11-53 can adjust the response speed of droop function. In the case of current oscillation appearance, please increase the value of 11-53.

<b>11- 54</b>	Output KWHr initialization
<b>Range</b>	<b>【0】</b> : Do not clear output KWHr <b>【1】</b> : Clear output KWHr

. If accumulative output energy reaches kilowatt-hour (12-40) the display data of motor can be reset by using the 11-54.

<b>11- 55</b>	STOP key selection
<b>Range</b>	<b>【0】</b> : Stop key is invalid when the operation command is not provided by operator. <b>【1】</b> : Stop key is valid when the operation command is not provided by operator.

- . When the operation command is input by terminal(00-02 = 1) or communication(00-02 = 3), this parameter can enable or disable the stop button of the digital operator.
- . 11-55= 0: Disabled (when the stop button is disabled, the operation command is input by the terminal or communication) .
- = 1: Enabled (The stop button is valid at any time) .

<b>11- 56</b>	UP/DOWN selection
<b>Range</b>	<b>【0】</b> : when operator's UP/DOWN is invalid , it will be valid if press ENTER after frequency modification. <b>【1】</b> : when operator's UP/DOWN is valid , it will be valid after frequency modification.

- 11-56 = 0: When the output frequency is modified by the UP/DOWN key, the modified frequency will be valid only after the ENTER key is pressed.
- = 1: When the output frequency is modified by the UP/DOWN key, the modified frequency will be valid immediately. It is no need to press ENTER key.
- . The output frequency can be changed (up or down) by the digital operator or by setting one of multi-functional digital input terminals (03-00, 03-07) to 8 and 9. Refer to instructions of (03-00 - 03-07 = 8 or 9).

<b>11- 58</b>	Record reference frequency
<b>Range</b>	<b>【0】</b> : Invalid <b>【1】</b> : Valid

- . This function is valid only when one of multi-function digital input terminals (03-00 to 03-07) is set to 11 (ACC / DEC disabled) or to 8 and 9 (up / down). Refer to the Figure 4.3.21 for the acceleration / deceleration disabled, and Figure 4.3.20 for up / down operation.

## 12-Monitoring Function Group

<b>12- 00</b>	Display screen selection (LED)
<b>Range</b>	<p style="text-align: center;"><b>0 000 0</b></p> <p style="text-align: center;"><b>Highest bit      lowest bit</b></p> <p>The range of each bit is <b>0~5</b> from the highest bit to the lowest bit,</p> <p><b>【0】</b> : No display  <b>【1】</b> : Output current  <b>【2】</b> : Output voltage  <b>【3】</b> : DC bus voltage  <b>【4】</b> : Heatsink temperature  <b>【5】</b> : PID feedback  <b>【6】</b> : AI1 value  <b>【7】</b> : AI2 value</p>

**Note:** The highest bit is the default boot interface, and the last 4 bits are the display set by users. You can select the contents to be displayed according to the requirement. (See figure in P4-4)

<b>12- 01</b>	PID feedback display mode (LED)
<b>Range</b>	<p><b>【0】</b> : Display the feedback value in integer (xxx)  <b>【1】</b> : Display the feedback value with one place after the decimal point (xx.x)  <b>【2】</b> : Display the feedback value (x.xx) with two places after the decimal point</p>
<b>12- 02</b>	PID feedback display unit setting (LED)
<b>Range</b>	<p><b>【0】</b> : xxxxx(no unit)  <b>【1】</b> : xxxPb(pressure)  <b>【2】</b> : xxxFL(flow)</p>

<b>12- 05</b>	Status display of digital input terminal (LED / LCD)
<b>Range</b>	Read-only (only read by panel)

- When any one of terminals **S1~S8** is turn on, the corresponding LED in **12- 05** will be lighted up, otherwise it is lighted off.
- When the relay has output, the corresponding LED will be lighted up, otherwise it is lighted off.

Example1: the following figure shows **S1~S8 is ON**, and the **12- 05** display (LED) when **RY1/RY2** has output at the same time.

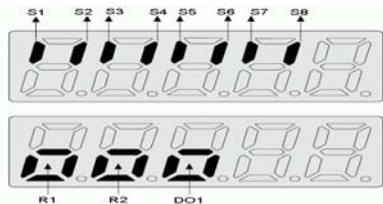

Example2: the following figure shows **S1~S8 is OFF**, and the **12- 05** display (LCD) when **RY1/RY2** has no output at the same time.

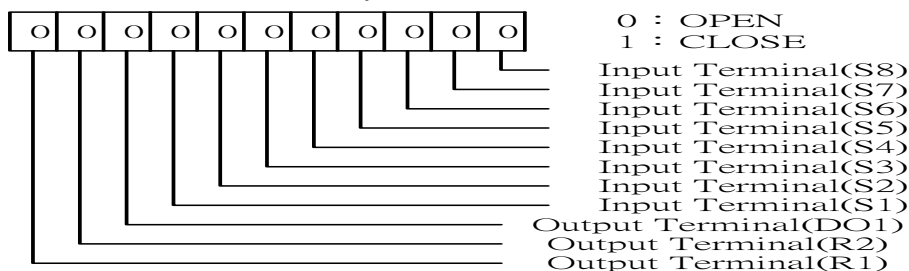

■ For other monitoring parameters 12-11~12-64, you can refer to the brief description in

### 13-Maintenance Function Group

<b>13- 00</b>	Inverter Capacity Selection
<b>Range</b>	----

Inverter model:	13- 00 display	Inverter model:	13- 00 display
A510-2001-XXX	201	A510-4001-XXX	401
A510-2002-XXX	202	A510-4002-XXX	402
A510-2003-XXX	203	A510-4003-XXX	403
A510-2005-XXX	205	A510-4005-XXX	405
A510-2008-XXX	208	A510-4008-XXX	408
A510-2010-XXX	210	A510-4010-XXX	410
A510-2015-XXX	215	A510-4015-XXX	415
A510-2020-XXX	220	A510-4020-XXX	420
A510-2025-XXX	225	A510-4025-XXX	425
A510-2030-XXX	230	A510-4030-XXX	430
A510-2040-XXX	240	A510-4040-XXX	440
A510-2050-XXX	250	A510-4050-XXX	450
A510-2060-XXX	260	A510-4060-XXX	460
A510-2075-XXX	275	A510-4075-XXX	475
A510-2100-XXX	2100	A510-4100-XXX	4100
A510-2125-XXX	2125	A510-4125-XXX	4125
A510-2150-XXX	2150	A510-4150-XXX	4150
		A510-4175-XXX	4175
		A510-4215-XXX	4215
		A510-4250-XXX	4250
		A510-4300-XXX	4300
		A510-4375-XXX	4375

<b>13- 01</b>	Software version
<b>Range</b>	----

<b>13- 03</b>	Cumulative operation hours 1
<b>Range</b>	<b>【0~23】 hour</b>
<b>13- 04</b>	Cumulative operation hours 2
<b>Range</b>	<b>【0~65535】 day</b>
<b>13- 05</b>	Selection of cumulative operation time
<b>Range</b>	<b>【0】</b> : Accumulative operation time while power on <b>【1】</b> : Accumulative operation time when it is operating.

.Using 13-05, the selected time is 13-03/13-04 (the past operation time )

. 13-05= 0: when the inverter power is supplied, the time is cumulative

= 1: time is cumulated only when the inverter is operating.

<b>13- 06</b>	Parameters lock
<b>Range</b>	<b>【0】</b> : Parameters out of 13-06 are unwritable. <b>【1】</b> : Retain <b>【2】</b> : all parameters are writable

<b>13- 07</b>	Parameter password function
<b>Range</b>	Retain

<b>13- 08</b>	Restore factory setting
<b>Range</b>	<b>【0】</b> : Do not initialize it. <b>【1】</b> : Retain <b>【2】</b> : 2-wire initialization (220/440V) <b>【3】</b> : 3-wire initialization (220/440V) <b>【4】</b> : 2-wire initialization (200/415V) <b>【5】</b> : 3-wire initialization (200/415V) <b>【6】</b> : 2-wire initialization (200/380V) <b>【7】</b> : 2-wire initialization (200/380V) <b>【Other】</b> : Retain

. Use parameter of 13-08 to initialize the inverter parameter. When initialization is completed, the inverter will return to factory default. It is recommended users to record the modification parameter setting values. After initialization, the value of 13-08 will return to zero automatically.

#### 13-08=2: 2-wire initialization (220V/440V)

- Multi-function digital input terminal S1 controls the execution of forward operation / stop command, and S2 controls the execution of reversal operation / stop command.  
Refer to Figure 4.3.1.
- Inverter input voltage (01-14) will automatically set 220V(220V class) or 440V(440V class)

#### 13-08=3: 3-wire initialization (220V/440V)

- Multi-function digital input terminal S5 controls the forward / reversal command, and terminals S1 and S2 become 3-wire type program to control operation command and stop command individually. Please refer to Figure 4.3.2 and Figure 4.3.3 for 3-wire type operation mode.
- Inverter input voltage (01-14) will automatically set 220V (220Vclass) or 440V(440V class).

#### 13-08=4: 2-wire initialization (200V/415V)

- The same as 2-wire type operation mode (13-08=2), Inverter input voltage (01-14) will automatically set 220V(220Vclass) or 440V(440V class).

#### 13-08=5: 3-wire initialization (200V/415V)

- The same as 3-wire type operation mode (13-08=3), Inverter input voltage (01-14) will automatically set 220V(220Vclass) or 440V(440V class).



13-08=6: 2-wire initialization (200V/380V)

- The same as 2-wire type operation mode (13-08=2), Inverter input voltage (01-14) will automatically set 220V(220Vclass) or 440V(440V class).

13-08=7: 3-wire initialization (200V/380V)

- The same as 3-wire type operation mode (13-08=3), Inverter input voltage (01-14) will automatically set 220V(220Vclass) or 440V(440V class)

<b>13-09</b>	Fault history clearance function
<b>Range</b>	<b>【0】</b> : Do not clear failure history <b>【1】</b> : Clear failure history

.13-09=1, failure tracking/failure history ( 12-11~12-15/12-45~12-64 ) will also be cleared.

## 14- PLC setting group

14- 00	T1 set value 1
14- 01	T1 set value 2 ( mode 7 )
14- 02	T2 set value 1
14- 03	T2 set value 2 ( mode 7 )
14- 04	T3 set value 1
14- 05	T3 set value 2 ( mode 7 )
14- 06	T4 set value 1
14- 07	T4 set value 2 ( mode 7 )
14- 08	T5 set value 1
14- 09	T5 set value 2 ( mode 7 )
14- 10	T6 set value 1
14- 11	T6 set value 2 ( mode 7 )
14- 12	T7 set value 1
14- 13	T7 set value 2 ( mode 7 )
14- 14	T8 set value 1
14- 15	T8 set value 2 ( mode 7 )
<b>Range</b>	<b>【0~9999】</b>

14- 16	C1 set value
14- 17	C2 set value
14- 18	C3 set value
14- 19	C4 set value
14- 20	C5 set value
14- 21	C6 set value
14- 22	C7 set value
14- 23	C8 set value
<b>Range</b>	<b>【0~65535】</b>

14- 24	AS1 set value 1
14- 25	AS1 set value 2
14- 26	AS1 set value 3
14- 27	AS2 set value 1
14- 28	AS2 set value 2
14- 29	AS2 set value 3
14- 30	AS3 set value 1
14- 31	AS3 set value 2
14- 32	AS3 set value 3
14- 33	AS4 set value 1
14- 34	AS4 set value 2
14- 35	AS4 set value 3
<b>Range</b>	<b>【0~65535】</b>

14- 36	MD1 set value 1
14- 37	MD1 set value 2
14- 38	MD1 set value 3
14- 39	MD2 set value 1
14- 40	MD2 set value 2
14- 41	MD2 set value 3
14- 42	MD3 set value 1
14- 43	MD3 set value 2
14- 44	MD3 set value 3
14- 45	MD4 set value 1
14- 46	MD4 set value 2

<b>14- 47</b>	<b>MD4 set value 3</b>
<b>Range</b>	<b>【0~65535】</b>

Please refer to section 4.4 for built-in PLC function

## 15- PLC Monitoring group

<b>15- 00</b>	<b>T1 current value 1</b>
<b>15- 01</b>	<b>T1 current value 2 ( mode 7 )</b>
<b>15- 02</b>	<b>T2 current value 1</b>
<b>15- 03</b>	<b>T2 current value 2 ( mode 7 )</b>
<b>15- 04</b>	<b>T3 current value 1</b>
<b>15- 05</b>	<b>T3 current value 2 ( mode 7 )</b>
<b>15- 06</b>	<b>T4 current value 1</b>
<b>15- 07</b>	<b>T4 current value 2 ( mode 7 )</b>
<b>15- 08</b>	<b>T5 current value 1</b>
<b>15- 09</b>	<b>T5 current value 2 ( mode 7 )</b>
<b>15- 10</b>	<b>T6 current value 1</b>
<b>15- 11</b>	<b>T6 current value 2 ( mode 7 )</b>
<b>15- 12</b>	<b>T7 current value 1</b>
<b>15- 13</b>	<b>T7 current value 2 ( mode 7 )</b>
<b>15- 14</b>	<b>T8 current value 1</b>
<b>15- 15</b>	<b>T8 current value 2 ( mode 7 )</b>
<b>Range</b>	<b>【0~9999】</b>

<b>15-16</b>	<b>C1 current value</b>
<b>15-17</b>	<b>C2 current value</b>
<b>15-18</b>	<b>C3 current value</b>
<b>15-19</b>	<b>C4 current value</b>
<b>15-20</b>	<b>C5 current value</b>
<b>15-21</b>	<b>C6 current value</b>
<b>15-22</b>	<b>C7 current value</b>
<b>15-23</b>	<b>C8 current value</b>
<b>Range</b>	<b>【0~65535】</b>

<b>15-24</b>	<b>AS1 current value</b>
<b>15-25</b>	<b>AS2 current value</b>
<b>15-26</b>	<b>AS3 current value</b>
<b>15-27</b>	<b>AS4 current value</b>
<b>15-28</b>	<b>MD1 current value</b>
<b>15-29</b>	<b>MD2 current value</b>
<b>15-30</b>	<b>MD3 current value</b>
<b>15-31</b>	<b>MD4 current value</b>
<b>15-32</b>	<b>TD current value</b>
<b>Range</b>	<b>【0~65535】</b>

## 16- LCM Function group

<b>16- 00</b>	Main screen monitoring
<b>Range</b>	<b>【5~64】</b>
<b>16- 01</b>	Sub-screen monitoring 1
<b>Range</b>	<b>【5~64】</b>
<b>16- 02</b>	Sub-screen monitoring 2
<b>Range</b>	<b>【5~64】</b>

. There are two displays of monitor when the power is supplied: the main-screen monitor and the sub-screen monitor.

. Choose the items to be displayed on the main-screen monitor screen by parameter 16-00, and the items to be displayed on the sub-screen monitor screen by parameters 16-01 and 16-02, so as to monitor parameters 12-5 ~ 12-64.

<b>16- 03</b>	Display unit
<b>Range</b>	<p><b>【0】</b> : The display unit of the frequency is 0.01Hz  <b>【1】</b> : The display unit of the frequency is 0.01%  <b>【2~38】</b> : rpm, the set value presents the number of motor pole  <b>【40~9999】</b> : Users determine the format, inputing 0XXXX means the display at 100% is XXXX  <b>【10000~19999】</b> : Users determine the format, inputing 1XXXX means the display at 100% is XXX.X  <b>【20000~29999】</b> : Users determine the format, inputing 1XXXX means the display at 100% is XX.XX  <b>【30000~39999】</b> : Users determine the format, inputing 1XXXX means the display at 100% is X.XXX</p>
<b>16- 04</b>	Engineering unit
<b>Range</b>	<p><b>【0】</b> : without using engineering unit  <b>【1】</b> : FPM  <b>【2】</b> : CFM  <b>【3】</b> : PSI  <b>【4】</b> : GPH  <b>【5】</b> : GPM  <b>【6】</b> : IN  <b>【7】</b> : FT  <b>【8】</b> : /s  <b>【9】</b> : /m  <b>【10】</b> : /h  <b>【11】</b> : °F  <b>【12】</b> : inW  <b>【13】</b> : HP  <b>【14】</b> : m/s  <b>【15】</b> : MPM  <b>【16】</b> : CMM  <b>【17】</b> : W  <b>【18】</b> : KW  <b>【19】</b> : m  <b>【20】</b> : °C</p>

(1) . Display unit of digital operator (16-03)

.Set the units of the following items to be displayed, the frequency reference (05-01,00-18,06-01 ~ 06-15) and the monitoring frequency 12-16,12-17 (Output frequency)

(2) . Display unit of engineering (16-04).

.when 16-03 = 00040-39999, the display unit of engineering is valid. The displayed set range and the frequency range of unit (05-01, 06-01~06-15) as well as the monitoring frequency (12-16, 12-17) are changed by parameters 16-04 and 16-03.

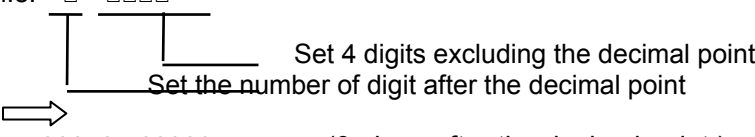
16-03 setting	Set / displayed contents			
0	0.01 Hz			
1	0.01 % (maximum output frequency 01-02=100%)			
2 - 39	RPM (RPM = 120 x reference frequency / the number of motor pole. The number of motor pole is set by 16-03)			
00040 - 39999	Set the decimal point by using the fifth place. i.e. □ □□□ 			
	16-03 setting	Display	Display unit	Example of display
	00040 - 09999	□□□□	follow 16-04 setting	Display 100 % of speed, set 0200 → set 16-03=00200 (from 05-01, 06-01 to 06-15, set the range to from 0040 to 9999) . → set 16-04=0 (without unit)
	10000 - 19999	□□□. □		Display 100 % of speed, set 200.0 CFM → set 16-03=12000 (05-01, 06-01 to 06-15, set the range to from 0000 to 9999). → set 16-04=2 (CFM) →For this case, 60% of speed will be displayed as 120.0 CFM
	20000 - 29999	□□. □□		Display 100 % of speed, set 65.00°C → set 16-03=26500 (05-01, 06-01 to 06-15, set the range to from 0000 to 9999) → set 16-04=20 (°C) →For this case, 60% of speed will be displayed as 39.00°C
30000 - 39999	□. □□□	Display 100 % of speed, set 2.555 m/s → set 16-03=32555 → set 16-04=14 (m/s) → For this case, 60% of speed will be displayed as 1.533 m/s		

<b>16- 05</b>	LCD backlight
<b>Range</b>	<b>【0~7】</b>

Adjust the screen contrast of the digital operator. If it is set to 0, the screen backlight is turned off.

<b>16- 06</b>	Automatic return time
<b>Range</b>	<b>【0~120】 Sec</b>

- . If the digital operator is not pressed within time 16-06 (returning time of automatic back button), the digital operator will automatically return to the mode screen.
- . When it is set to 0, the automatic return function is turned off. Press the back button to return to the previous directory.

<b>16- 07</b>	Copy function selection
<b>Range</b>	<b>【0】</b> : Do not copy parameter <b>【1】</b> : Read inverter parameters and save to the operator. <b>【2】</b> : Write the operator parameters to inverter <b>【3】</b> : Compare parameters of inverter and operator.
<b>16- 08</b>	Selection of allowing reading
<b>Range</b>	<b>【0】</b> : Do not allow to read inverter parameters and save to the operator <b>【1】</b> : Allow to read inverter parameters and save to the operator

- . LCD digital operator with built-in memory (EEPROM) can execute the following functions:
  - (1) Read: Save the parameters of the inverter to the digital operator (INV → OP).
  - (2) Write: Write the parameters of the digital operator to the inverter and save (OP → INV).
  - (3) Verify: Compare the set value of the inverter to the parameter of the digital operator
    - . 16-07=0: No action
      - =1: Read (all parameters will be copied from the inverter to the digital operator).
      - =2: Write (all parameter will be copied from the digital operator to the inverter).
      - =3: Verify (Compare the set value of the inverter to the parameter of the digital operator).
- . Set 16-08 = 0, in order to prevent the stored data in the digital operator will not be accidentally overwritten. If 16-07 = 1 and the read operation (save the inverter parameter setting and set the digital operator) is executed, a warning message of "RDP Read Prohibited" will be displayed on the digital operator, and the read operation will be stopped.
- . Refer to the following steps for copy function operation.
  - When the write-in operation is used, check the following settings and ensure they are the same:
    - ① Software version
    - ② Control method
    - ③ Inverter type
    - ④ Inverter rated capacity and voltage
  - When one of the parameters from 03-00 to 03-07 (multi-function digital input selection) is set to 49 (Enable the parameter write-in function), when the terminal is on, all parameters can be written into the converter from the digital operator. When it is off, all the parameters, excluding the reference frequency (00-05), are all write protection.

■ **READ:** Use the following steps to store the parameter settings of the inverter to the operation interface of the digital operator.

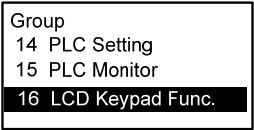
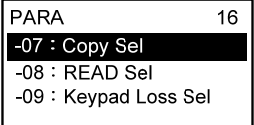
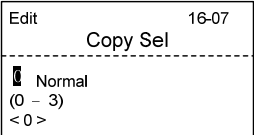
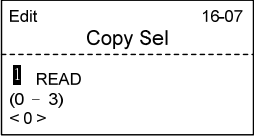
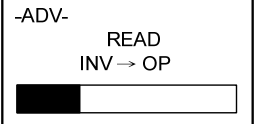
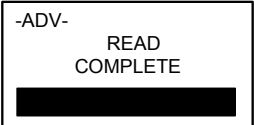
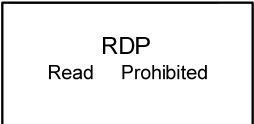
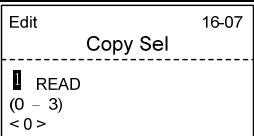

Steps	Screen display (English)	Description
1		Select the copy function group (16) from the groups menu.
2		Press the Data / Enter key and select the parameter (16-07) display of copy function.
3		Press the Data / Enter key to display the data setting / read screen (the digital is reversed video and flicker).
4		Change the set value to 1 (read) by using increase key.
5		<ul style="list-style-type: none"> <li>. Use data/enter key to enable the read operation, the display is shown as the left.</li> <li>. The bottom of LCD display will show a bar to indicate the read progress.</li> </ul>
6		"READ COMPLETE" will be displayed on the digital operator interface after reading is successful.
		<ul style="list-style-type: none"> <li>. The error message of "RDP Read Prohibited" may occur in the memory of the interface when storing the inverter parameter settings to the digital operator.</li> <li>. If the error is displayed, press any key to remove the error message and back to the display 16-07.</li> </ul>
7		. When DSP/FUN key is pressed, the display returns to the sub-directory (16-07).

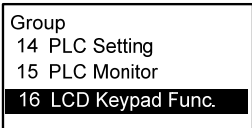
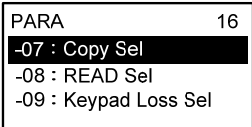
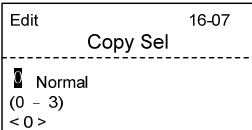
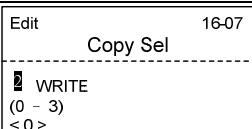
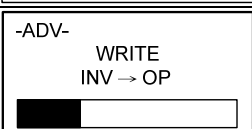
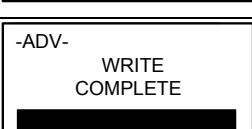
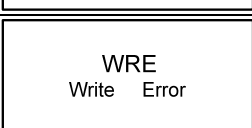
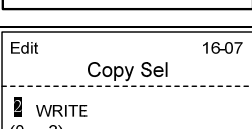
- **Write:** Use the following steps to write in the parameter settings of the operation interface of digital operator to the inverter.

Steps	LCD Display (English)	Description
1		Select the copy function group (16) from the groups menu.
2		Press the Data / Enter key and select the parameter (16-07) display of copy function.
3		Press the Data / Enter key to display the data setting / read screen. (the digital is reversed video and flicker).
4		Change the set value to 2 (write) by using increase key.
5		<ul style="list-style-type: none"> <li>. Use data/enter key to enable the write operation, the display is shown as the left.</li> <li>. The bottom of LCD display will show a bar to indicate the write progress.</li> </ul>
6		"WRITE COMPLETE" will be displayed on the digital operator interface after writing is successful.
		<ul style="list-style-type: none"> <li>. The error message of " WRE Write Error " may occur in the memory of the interface when storing the inverter parameter settings to the digital operator.</li> <li>. If the error is displayed, press any key to remove the error message and back to the display 16-07.</li> </ul>
7		when DSP/FUN key is pressed, the display returns to the sub-directory (16-07)

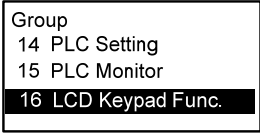
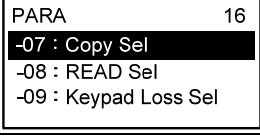
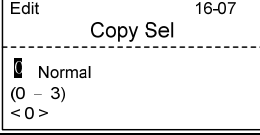
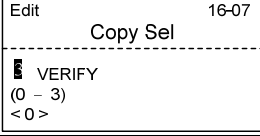
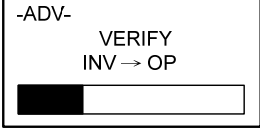

- **Verify:** Use the following steps to compare the inverter parameter to the set value of the operation interface of digital operator.

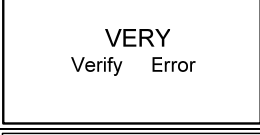
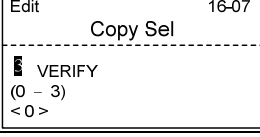
Steps	LCD Display (English)	Description
1		Select the copy function group (16) from the groups menu.
2		Press the Data / Enter key and select the parameter (16-07) display of copy function.
3		Press the Data / Enter key to display the data setting / read screen (the digital is reversed video and flicker).
4		Change the set value to 3 (verify) by using increase key.
5		<ul style="list-style-type: none"> <li>. Use data/enter key to enable the confirming operation, the display is shown as the left.</li> <li>. The bottom of LCD display will show a bar to indicate the write-in progress.</li> </ul>
6		If data is successfully confirmed, the message of “VERIFY COMPLETE” will display.
		<ul style="list-style-type: none"> <li>. An erro message of “VRYE Verify Error” may occur, please confirm it.</li> <li>. If the error is displayed, press any key to remove the error message and back to the display 16-07.</li> </ul>
7		when DSP/FUN key is pressed, the display returns to the sub-directory (16-07)

<b>16- 09</b>	Selection of operator breaking off (LCD)
<b>Range</b>	<b>【0】</b> : Display fault when LCD operator is broken off. <b>【1】</b> : Keep operating when LCD operator is broken off.

.In Local mode, when the digital operator is removed, this parameter determines whether the inverter should be stopped or not.

## 17- Automatic Tuning Function Group

<b>17- 00</b>	<b>Mode selection of automatic tuning</b>
<b>Range</b>	<b>【0】</b> : Rotation autotune <b>【1】</b> : Static autotune <b>【2】</b> : Stator resistance measurement (V / F)
<b>17- 01</b>	Motor rated output power
<b>Range</b>	<b>【0.00~600.00】 KW</b>
<b>17- 02</b>	Motor rated current
<b>Range</b>	For VF, VF+PG modes, it is 10%~200% of the inverter rated current For SLV, SV modes, it is 25%~200% of the inverter rated current.
<b>17- 03</b>	Motor rated voltage
<b>Range</b>	<b>【0.0~255.0】 V: 220V</b> <b>【0.0~510.0】 V: 440V</b>
<b>17- 04</b>	Motor rated frequency
<b>Range</b>	<b>【10.0~400.0】 Hz</b> <b>【10.0~1200.0】 Hz</b> (when 00-31 = 1)
<b>17- 05</b>	Motor rated speed
<b>Range</b>	<b>【0~24000】 rpm</b>
<b>17- 06</b>	Pole number of motor
<b>Range</b>	<b>【2,4,6,8】 pole</b>
<b>17- 07</b>	Number of PG pulse
<b>Range</b>	<b>【0~60000】 ppr</b>
<b>17- 08</b>	Motor no-load voltage
<b>Range</b>	<b>【50~240】 V: 220V</b> <b>【100~480】 V: 440V</b>
<b>17- 09</b>	Motor excitation current
<b>Range</b>	<b>【0.01~600.00】 A</b>
<b>17- 10</b>	Automatic tuning start
<b>Range</b>	<b>【0】</b> : Invalid <b>【1】</b> : Valid
<b>17- 11</b>	<b>Error history of automatic tuning</b>
<b>Range</b>	<b>【0】</b> : No error <b>【1】</b> : Motor data error <b>【2】</b> : Stator resistance tuning error <b>【3】</b> : Leakage induction tuning error <b>【4】</b> : Rotor resistance tuning error <b>【5】</b> : Mutual induction tuning error <b>【6】</b> : Encoder error <b>【7】</b> : DT Error <b>【8】</b> : Motor's acceleration error <b>【9】</b> : Warning

\*1. Set value is for 220V class, the value of its two times is for 440V class.

\*2.The set range from 0.0 to 400.0 Hz is for HD mode (00-27=0), and from 0.0 to 120.0Hz is for ND mode (00-27=1) , and from 0.0 to 1200.0Hz is high frequency mode (00-31=1).

- . Set motor nameplate's rated output power (17-01), motor output rated current (17-02), motor rated voltage (17-03),motor rated frequency (17-04),motor rated speed (17-05) and motor's pole number (17-06) and so on for automatic tuning operation.

- Automatic tuning mode selection (17-00)
  - . If it is the static-type automatic tuning (17-00 = 1), then the motor can not be operating in the process of the automatic tuning. The rotary-type automatic tuning (17-00 = 0) can obtain higher performance.
  - . 17-00=2 is for the applications of long wire.
- Motor rated output power (17-01)
  - . Set by inverter capacity (13-00)
- Motor rated current (17-02)
  - . Set by inverter capacity (13-00)
  - . Set the range to 10 %~200 % of the inverter rated current.
- Motor rated voltage (17-03)
- Motor rated frequency (17-04)
- Motor rated speed (17-05)
  - . For the special inverter or motor, such as motor speed, constant power motor or tool spindle motor and so on, the motor rated voltage or rated motor frequency is lower than that of normal motor. It is necessary to firstly confirm the nameplate information or the motor test report.
  - . When the motor rated voltage is higher than the inverter input voltage, it is required to prevent the inverter output voltage saturation (see Example 1).

*Example 1:* Motor rated voltage (440V/60Hz) is higher than the inverter input voltage (380V/50 Hz).

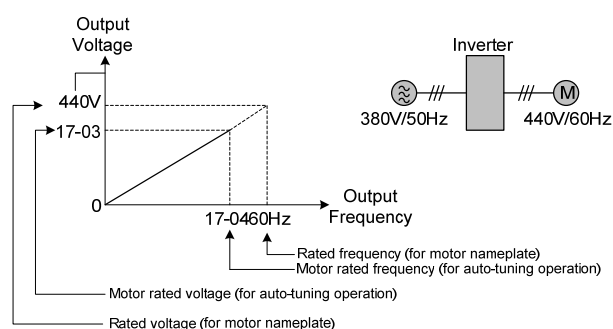

**Figure 4.3.98 Rated voltage and frequency settings**

Step 1: Set motor rated voltage, 17-03 =440V.

Step 2: Set no-load voltage, 17-08=360V, for the set value of the torque control lower than the input voltage 20V.

Step 3: Set motor rated frequency:

$$17-04 = (\text{Rated frequency of motor nameplate}) \times \frac{(\text{Inverter input power voltage})}{(\text{Rated frequency of motor nameplate})} = 60\text{Hz} \times \frac{380}{440\text{V}} = 51.8\text{Hz}$$

Step 4: Automatically tuning

Parameter 01-12 (Fbase) is automatically set in the period of automatic tuning. Basically, 01-12(Fbase) is set to the motor rated frequency.

Step 5: Set 01-12(Fbase) the the rated frequency on the motor nameplate. If the maximum output frequency (01-02, Fmax) and basic frequency (01-12, Fbase) are different, set the maximum output frequency after the completion of automatic tuning(01-02, Fmax).

- . When the inverter input power supply voltage (or frequency) is higher than the motor rated voltage (or frequency), set the motor rated voltage (17-03) and the motor rated frequency (17-04) to the rated frequency on the motor nameplate.

Example 2: The inverter input voltage and frequency (440V/50Hz) are higher than the motor rated voltage and frequency (380V/33Hz), set 17-03 = 380V (rated motor voltage) and 17-04 = 33Hz (motor rated frequency).

- Pole number of motor (17-06)
  - Set the motor pole number with its range is 2, 4, 6 and 8 poles
- Number of PG pulse (17-07)
  - Set the pulse number of each cycle. If the control mode is SV mode and the V / F + PG mode, the encoder must be installed on the motor shaft and there is no reduction gear ratio.
- Motor no-load voltage (17-08)
  - . Motor no-load voltage is mainly for SV or SLV mode, whose set value is lower than the input voltage of 10~50V can ensure the torque performance at the rated frequency.
  - . Set to about 85 ~ 95% of the motor rated voltage. In general, the set motor no-load voltage can be closer to the motor rated voltage for the greater motor, but can not exceed the rated voltage.
  - . The motor no-load voltage can be set to the value greater than the actual input voltage. For this case, the motor can only operates under relatively low frequency. If the motor operates under the rated frequency, the failure of over voltage may easily occur.
  - . The higher the motor power is, the greater the no-load voltage is.
  - . The smaller no-load voltage will reduce the no-load current. When the load is added, the magnetic flux is weakened and the current is increased.
  - . The higher no-load voltage is, the greater no-load current is. When the load is added, the magnetic flux is weakened and the current is increased. Increasing magnetic flux easily generates back EMF and the torque control easily fails.
- Motor excitation current (17-09)
  - . Motor excitation current is mainly for the cases that the rotary automatic tuning can not be executed.
  - . Motor excitation current is set to 30% of the motor rated current.
  - . If this parameter is not set, the inverter will use its own internal parameters to calculate related parameters.
  - . Only the static-type automatic tuning (17-00 = 1) can be set.
- Automatic tuning start (17-10)
  - . Select 1 for 17-10 and press ENTER, You can enter the screen of motor automatic tuning and the operator will appear a message of "Atrdy". Press RUN to start the motor automatic tuning and the operator will appear a message of "Atune". When the motor is successfully tuned, the message of "AtEnd" will appear.
- Error history of automatic tuning (17-11)
  - If the motor automatic tuning process fails, it will display a message of "AtErr". The error message will be displayed in 17-11.
  - For automatic tuning error causes and troubleshooting, you can refer to section 5.
  - Note: The motor tuning error history (17-11) records the tuning result of last time. If the tuning is given up or successful, then no error is displayed.
  - Long wire between the motor and the inverter
  - . When the wiring between the motor and the inverter is longer than 50m, please be sure to perform static-type automatic tuning on the long wire (17-00 = 2). If you want to obtain the vector control with high efficiency, please firstly perform the

- rotary-type automatic tuning (17-00 = 0) by using a short wire, and then perform the static-type automatic tuning (17-00 = 2) by using long wire.
- If the rotary-type automatic tuning (17-00 = 0) can not be performed, please manually enter the mutual induction (02-18), excitation current (02-09), core saturation compensation factor 1-3 (02-11 - 02-13) .
- For the V / F control, the long wire must be performed with the static-type automatic tuning (17-00 = 2).

### 18- Slip compensation Group

<b>18- 00</b>	Slip compensation gain at low speed
<b>Range</b>	<b>【0.00~2.50】</b>
<b>18- 01</b>	Slip compensation gain at high speed
<b>Range</b>	<b>【-1.00~1.00】</b>
<b>18- 02</b>	Slip compensation limit
<b>Range</b>	<b>【0~250】 %</b>
<b>18- 03</b>	Slip compensation filter
<b>Range</b>	<b>【0.0~10.0】 Sec</b>
<b>18- 04</b>	Regenerating slip compensation selection
<b>Range</b>	<b>【0】 : Invalid 【1】 : Valid</b>
<b>18- 05</b>	FOC delay time
<b>Range</b>	<b>【1~1000】 mSec</b>
<b>18- 06</b>	FOC gain
<b>Range</b>	<b>【0.00~2.00】</b>

- No matter how the load changes, the slip compensation function will calculate the motor torque based on the output current and control the motor operating at constant speed.
- When the load is changed by operating, this function is used to improve the accuracy of the speed, mainly for the V / F control mode.

### V/F mode adjustment

(1) Slip compensation gain at low speed (18-00) .

.the default setting of 18-00 is 0.0 (when 18-00 = 0.0, the slip compensation function is closed.)

. The adjustment of slip compensation gain at low speed follows the below procedure:

- ① Correctly set the rated slip and the no-load current (02-00).
- ② Set the slip compensation (18-00) to 1.0 (SLV) (factory default setting is 0.0, V / F control mode)

③ For the operation with load, measure the speed and adjust the slip gain (18-00) and increase by the unit of 0.1.

– If the speed is lower than frequency reference, increase the set value of 18-00.

– If the speed is higher than frequency reference, decrease the set value of 18-00.

When the output current is greater than the no-load current (02-00), the slip compensation is enabled, the output frequency will increase from f1 to f2. Refer to Figure 4.3.99., the slip compensation follows the below formula:

$$\text{Slip compensation value} = \text{Motor rated sync induction rotation difference} \times \frac{[\text{output current (12-08)} - \text{motor no-load current (02-00)}]}{[\text{motor output rated current (02-01)} - \text{motor no-load current (02-00)}]}$$

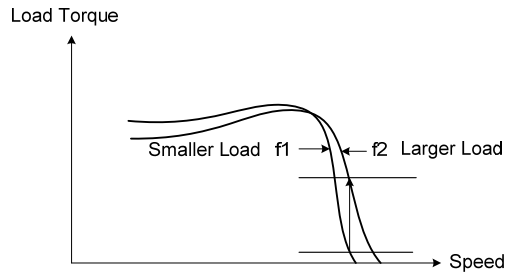
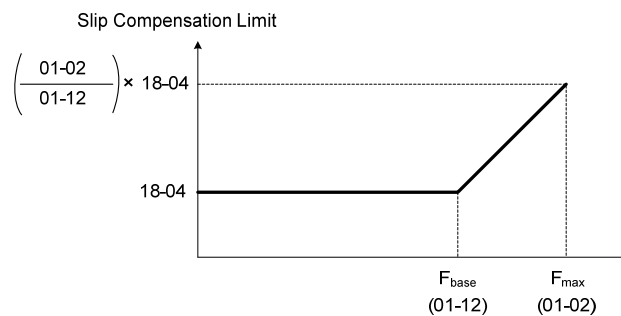

**Figure 4.3.99 Slip compensation output frequency**

(2) Slip compensation limit (18-02)

. Slip compensation limit 18-02 setting, the constant torque and the constant power as shown in Figure 4.3.100

. if 18-02 is set to 0%, the slip compensation is closed.



**Figure 4.3.100 Slip compensation limit**

If the slip compensation gain 18-00 at low speed is adjusted, and the actual motor speed is still lower than the reference frequency, the the motor may get the slip compensation limit.

Please be sure that the slip compensation limit 18-02 of this value and the reference frequency will not exceed the allowed limited of the machine.

(3) Slip compensation filter (18-03) .

.Filter time of the slip compensation in V/F mode

(4) Regenerating slip compensation selection (18-04) .

. The selections to enable or disable the slip compensation function in the regenerating period.

. For the regenerating period (deceleration, in the SLV mode, set 18-04 to 1 if there is speed accuracy requirement (enabled).

When the slip compensation function is used, the renewable energy increase contemporarily(18-04 = 1). In this case, the braking module might be required (Braking resistance).

**SLV mode adjustment**

(1) Slip compensation gain

. Under the condition of load coupled, it can be set to control the speed accuracy of all range.

.If the speed is lower than 2 Hz and the motor speed decreases, increase the set value of 18-00

.If the speed is lower than 2 Hz and the motor speed increases, reduce the set value of 18-00

In all range of speed control accuracy, 18-00 is set to a fixed value. As a result, although the accuracy adjustment at low speed is performed, some slight errors still are generated at high speed. If the speed error of high speed is not accepted, you can use 18-02 together with the compensation value or continue to adjust 18-00, but the

accuracy at low speed might be sacrificed.  
 The impacts of 18-00 on the torque and the speed are shown as the following figure:

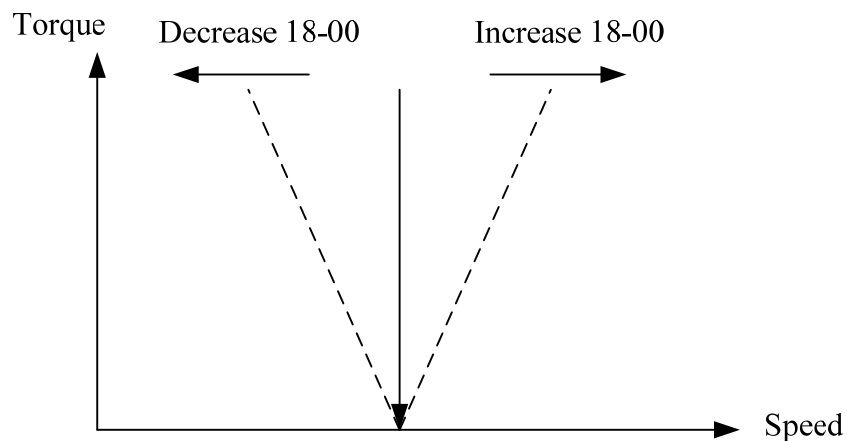

**Figure 4.3.101 18-00 Impact on the torque and speed**

(2) Slip compensation gain at high speed (18-01)

. In the case of load coupling, it is no need to adjust the accuracy at high speed in the control using this parameter.

.After 18-00 is adjusted, increase the reference frequency and observe whether the speed has error. If the speed error exists, you can increase the set value of 18-01 for compensation.

.Increase the motor rated frequency (01-12 basic frequency ), increase the set value of 18-01, so as to reduce the speed error.

.If the speed accuracy becomes poorer due to over high temperature of the motor, it is more appropriate to use 18-00 and the set value of 18-01 for adjustment.

.Compared to 18-00, 18-01 is different because 18-01 is a variable gain value in the full speed range.

18-01 determines the slip compensation at the motor rated rotation, its principle calculation is shown as below:

$$\text{Slip compensation gain} = \text{Slip compensation gain at low speed} + \text{Slip compensation gain at high speed} * (\text{frequency reference} / \text{Motor rated frequency (01-12)})$$

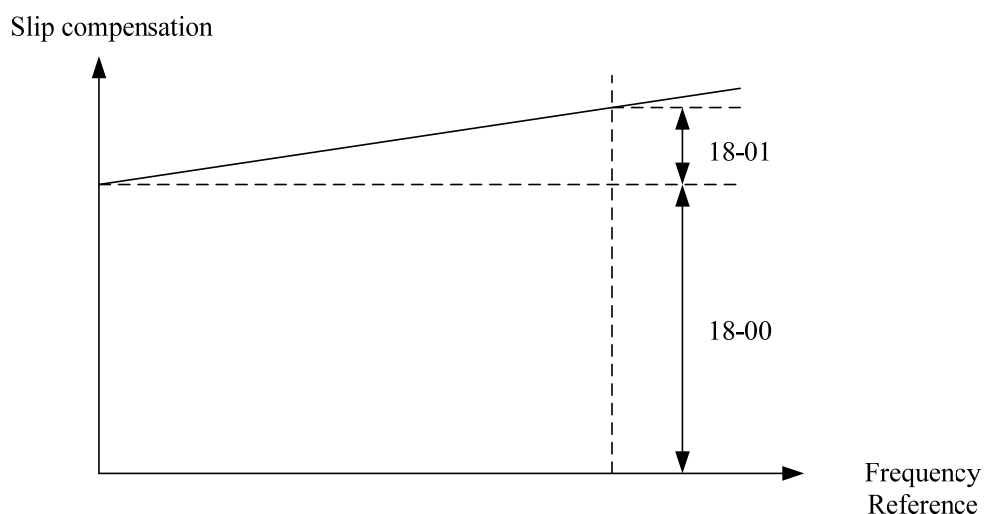

**Figure 4.3.102 18-00/18-01 Slip compensation gain v.s frequency referency**

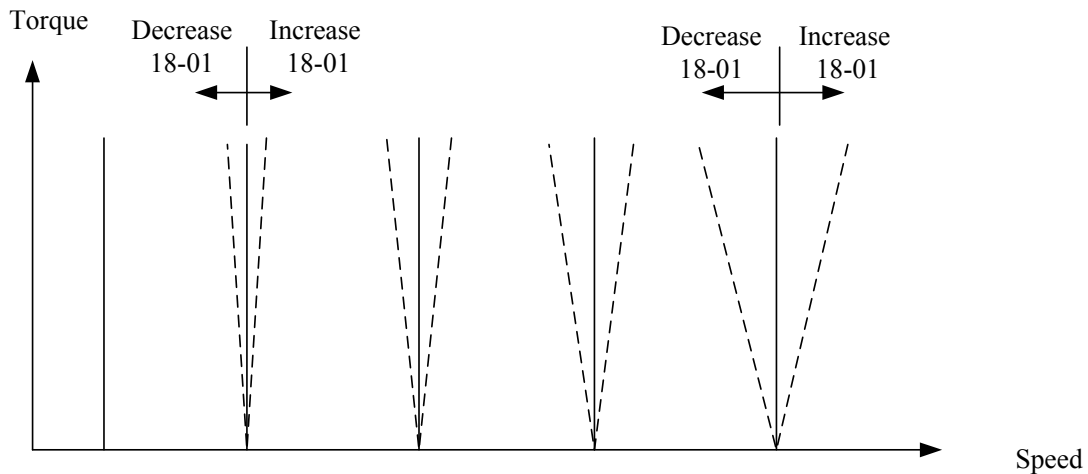

**Figure 4.3.103 18-01 Impact on torque speed curve**

**(3) FOC(Flux Orient Control) delay time (18-05)**

- . In the SLV mode, the slip compensation of the magnetic flux depends on the torque current and excitation current.
- . If the motor bears the load exceeding 100% at the motor rated frequency, the voltage of the pole and the resistance sharply drops, which might cause the inverter output saturation and the current jitter. The magnetic flux slip compensation will decouple the torque current and the excitation current, then the current jitter will be resolved.
- . 18-05 Set delay time of the magnetic flux slip
- . In the slow or steady operation, 18-05 can be increased. For the fast operation, you have to adjust 18-06.

**(4) Slip compensation gain 18-06 setting**

- . If the motor is jittering at the rated frequency and full load, the set value of 18-06 will gradually reduce to zero for jitter reduction.

**19- Wobble Frequency function group**

<b>19- 00</b>	Center frequency of wobble frequency
<b>Range</b>	<b>【5.00~100.00 】 %</b>
<b>19- 01</b>	Amplitude of wobble frequency
<b>Range</b>	<b>【0.1~20.0】 %</b>
<b>19- 02</b>	Jump frequency of wobble frequency
<b>Range</b>	<b>【0.0~50.0】 %</b>
<b>19- 03</b>	Jump time of wobble frequency
<b>Range</b>	<b>【0~50】 mSec</b>
<b>19- 04</b>	Wobble frequency cycle
<b>Range</b>	<b>【0.0~1000.0】 Sec</b>
<b>19- 05</b>	Wobble frequency ratio
<b>Range</b>	<b>【0.1~10.0】 mSec</b>
<b>19- 06</b>	Upper offset amplitude of wobble frequency
<b>Range</b>	<b>【0.0~20.0】 %</b>
<b>19- 07</b>	Lower offset amplitude of wobble frequency
<b>Range</b>	<b>【0.0~20.0】 %</b>

.Wobble operation is only used in V/F and V/F+PG control mode. To compensate the fast frequency in the inertia system, jump can be included.



.Please refer to the figure 4.3.104 for the wobble operation and the related parameter setting

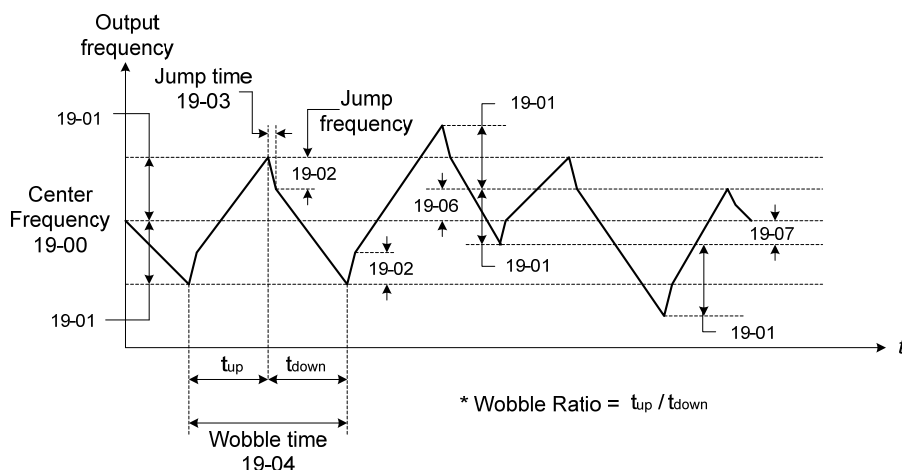

**Figure 4.3.104 Wobble operation and the related parameter setting**

In wobble operation, one of multifunction digital inputs (03-00 to 03-07) is set to 37 (wobble operation) and the input of inverter operation command will be enabled. When the wobble operation is ready, the inverter output frequency reaches the center frequency (19-00). The acceleration time to the center frequency is the original pre-set acceleration time (Tacc 1 to Tacc 4). When the wobble operation is closed or the operation command is removed, the deceleration time is the original pre-set deceleration time (Tdec 1 to Tdec4). However, in the wobble operation, the inverter should operate in the hopping time (19-04,  $t_{up} + t_{down}$ ) and hopping frequency (19-05,  $t_{up} / t_{down}$ ).

- . Set multi-function digital output terminals (R1A-R1C, R2A-R2C) to the output wobble operation (in acceleration) by setting from 03-11 to 03-12 to 20 or 21.
- . Refer to the following figure 4.3.105 for the ON / OFF control of wobble

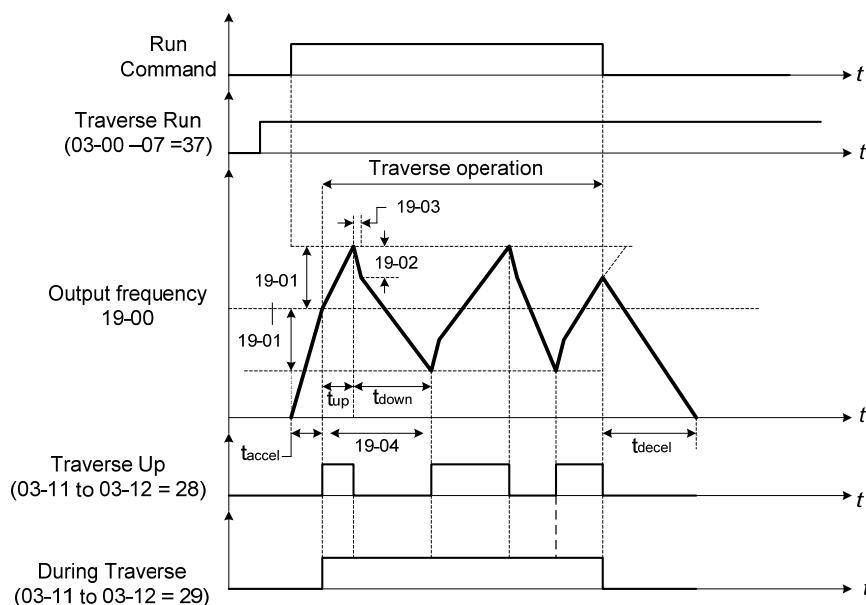

**Figure 4.3.105 ON/OFF control of wobble**

- . In the wobble operation, the center frequency can be controlled by one of multi-function digital inputs. However, the command of wobble upper offset (03-00 to 07 = 38) and the command of wobble lower offset (03-00 to 07 = 39) can not be input at the same time, otherwise the inverter will maintain the original center frequency (19 - 00). Refer to Figure 4.3.106.

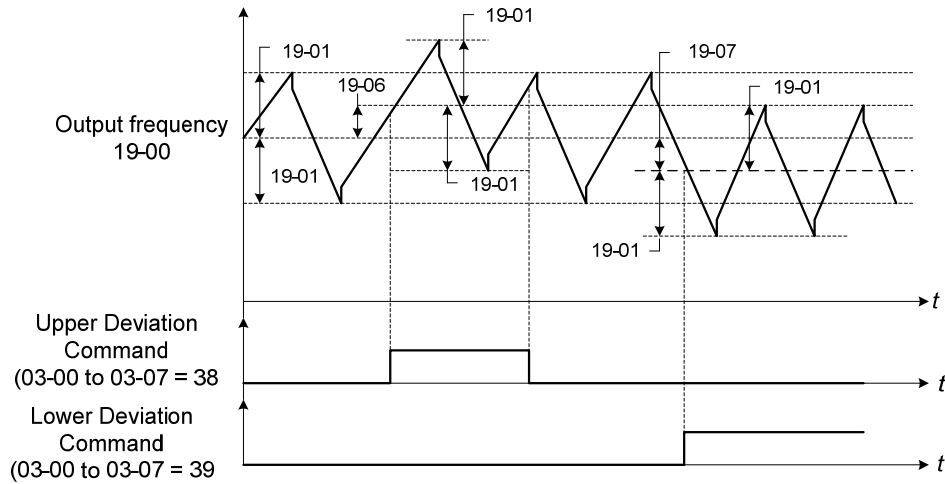

**Figure 4.3.106 Upper/Lower offset operation**

- . When the stall prevention function is idle, perform the wobble operation in acceleration and deceleration. However, it is actually performed in the process of the first acceleration center frequency (19-00) when the wobble function is closed or the command is deleted after a period of deceleration operation. However, you have to consider selecting appropriate inverter capacity to match the system requirement and the designed device.
- . The limited wobble operation of this frequency range is determined by the upper limit and lower limit of the inverter frequency. If (center frequency + amplitude) is greater than the upper frequency limit, it will operate at the upper limit; if (center frequency - Amplitude) is less than the lower frequency limit, it will operate at lower limit.
- . In the wobble operation, all parameter values (19-00,19-07) can be modified.

## 20- Speed Control Function Group

<b>20- 00</b>	ASR gain 1
<b>Range</b>	<b>【0.00~250.00】</b>
<b>20- 01</b>	ASR integral time 1
<b>Range</b>	<b>【0.001~10.000】 Sec</b>
<b>20- 02</b>	ASR gain 2
<b>Range</b>	<b>【0.00~250.00】</b>
<b>20- 03</b>	ASR integral time 2
<b>Range</b>	<b>【0.001~10.000】 Sec</b>
<b>20- 04</b>	ASR integral time limit
<b>Range</b>	<b>【0~300】 %</b>
<b>20- 05</b>	ASR positive limit
<b>Range</b>	<b>【0.1 ~ 10】 %</b>
<b>20- 06</b>	ASR negative limit
<b>Range</b>	<b>【0.1 ~ 10】 %</b>
<b>20- 07</b>	Selection of acceleration and deceleration of P/PI
<b>Range</b>	<b>【0】 : PI speed control will be valid only in constant speed. For the speed acceleration and deceleration, only use P control.</b> <b>【1】 : Speed control is valid either in acceleration or deceleration.</b>
<b>20- 08</b>	ASR delay time
<b>Range</b>	<b>【0.000~0.500】 Sec</b>
<b>20- 09</b>	Speed Observer Proportional(P) Gain1
<b>Range</b>	<b>【0.00~2.55】</b>

<b>20- 10</b>	Speed Observer Integral(I) Time 1
<b>Range</b>	<b>【0.01~10.00】 Sec</b>
<b>20- 11</b>	Speed Observer Propotional(P) Gain2
<b>Range</b>	<b>【0.00~2.55】</b>
<b>20- 12</b>	Speed Observer Integral(I) Time 2
<b>Range</b>	<b>【0.01~10.00】 Sec</b>
<b>20- 13</b>	Low-pass filter Time constant of speed feedback 1
<b>Range</b>	<b>【1~1000】 mSec</b>
<b>20- 14</b>	Low-pass filter Time constant of speed feedback 2
<b>Range</b>	<b>【1~1000】 mSec</b>
<b>20- 15</b>	ASR gain change frequency 1
<b>Range</b>	<b>【0.0~400.0】 Hz</b>
<b>20- 16</b>	ASR gain change frequency 2
<b>Range</b>	<b>【0.0~400.0】 Hz</b>
<b>20- 17</b>	Torque compensation gain at low speed
<b>Range</b>	<b>【0.00~2.50】</b>
<b>20- 18</b>	Torque compensation gain at high speed
<b>Range</b>	<b>【-10~10】 %</b>

. The following figure is the architecture of speed control cycle (ASR).

(a) V/F + PG control mode:

.Speed control system (ASR) tunes the output frequency, to make the frequency reference and the feedback speed close to 0.

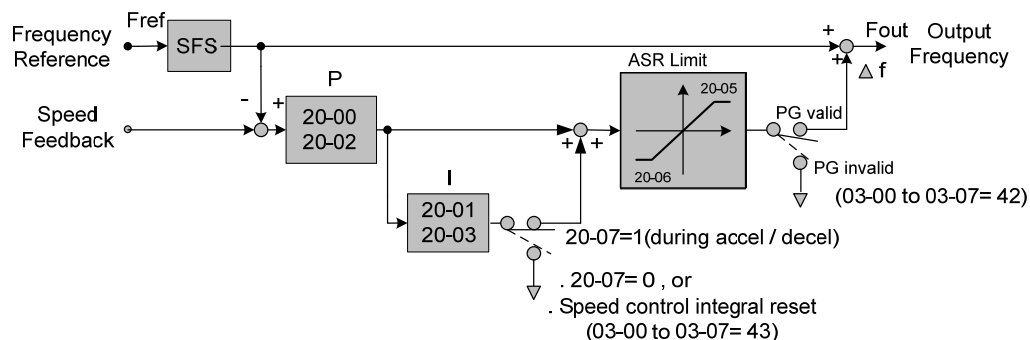

**Figure 4.3.107 Speed control architecture (V/F + PG)**

. When the multi-function input (03-00 to 03-07) is set to 42 (PG is invalid), the input can be used to enable or disable the speed control loop system (ASR).

(b)SLV control mode :

.Speed control system (ASR) tunes the output frequency, to make the frequency reference and the feedback speed close to 0.

. The ASR controller of SLV mode is designed with a speed estimate device to estimate the motor speed. In order to reduce the interference in the speed feedback signal, a low-pass filter and speed feedback compensator can be added.

. ASR integrator output can be removed or restricted. All outputs are through the low-pass filter. The torque will also be limited.

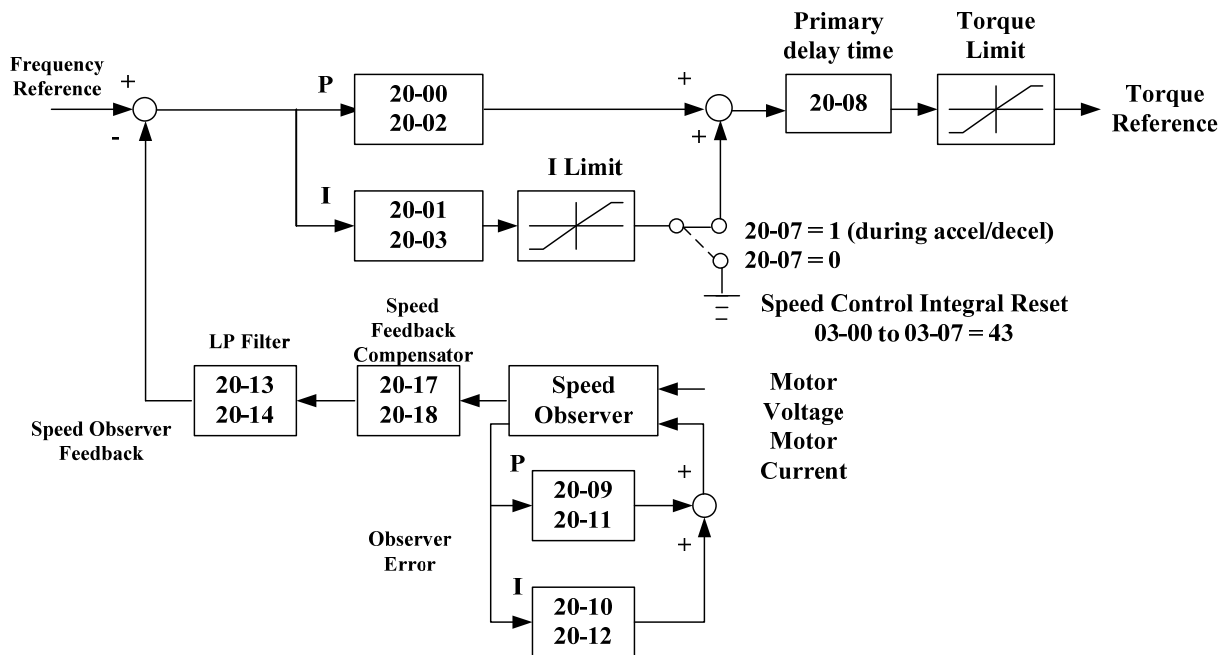

Figure 4.3.108 Speed control architecture (SLV mode )

(c)SV control mode and PMSV mode:

- . Speed control system (ASR) tunes the output frequency, to make the frequency reference and the feedback speed close to 0.
- . ASR integrator output can be removed or restricted. All outputs are through the low-pass filter. The torque will also be limited.

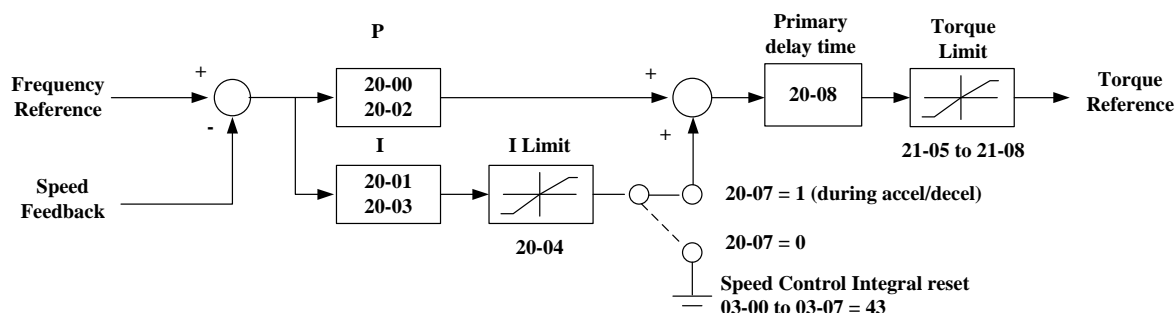

Figure 4.3.109 Speed control architecture (SV mode )

### A. The ASR setting of V/F +PG control mode

- (1) In V/F+PG mode, set the proportional (P) gain and integral (I) time at the minimum output frequency (20-02 and 20-03) and maximum output frequency (20-00 and 20-01) . Refer to the figure 4.3.110.

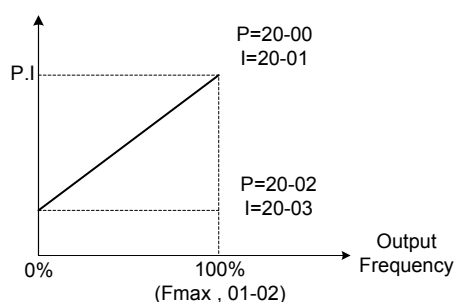

Figure 4.3.110 ASR gain setting (V/F+PG)

(2) Tune the speed control ASR gain :

Follow the below steps to tune the gain.

a. The gain tuning of the minimum output frequency

- . Make the motor operate at the lowest output frequency.
- . Improve the ASR proportional gain 2 (20-02) as much as possible, which will not cause instability.
- . Reduce the ASR integral time 2(20-03) as much as possible, which will not cause instability.
- . Confirm the output current is less than 50% of the inverter rated current. If the output current is more than 50% of the inverter rated current, reduce 20-02 and increase 20-03.

b. The gain tuning of maximum output frequency

- . Make the motor operate at the highest output frequency (Fmax) .
- . Improve the ASR proportional gain 1 (20-00) as much as possible, which will not cause instability.
- . Reduce the ASR integral time 1(20-02) as much as possible, which will not cause instability.

c. The gain tuning of acceleration / deceleration integral control (20-07)

- . In the acceleration / deceleration set 20-07 = 1 (enabled) period, the integral control is enabled.
- . Integral control enables the motor speed reaches the target speed as soon as possible, but it may result in overshoot or less, as shown in Figure 4.3.113 & 4.3.114.
- . When one of multi-function digital inputs (03-00 to 03-07) is set to 43 (speed control integral reset), the input can be used to switch the P control and PI control of the speed control loop system (ASR). When the multi-function digital input is on, it is used for P control (integral reset).
  - If the speed overshoot occurs, reduce 20-00 system (ASR proportional gain 1) and increase the 20-01 system (ASR integral time 1).
  - If the speed is less, reduce 20-02 system (ASR proportional gain 2) and increase 20-03 (ASR integral time 2).
  - If you can not eliminate the speed overshoot or less by the above gain tuning, reduce the ASR + / - limit (20-05 / 20-06), so as to decrease the reference frequency compensation ( $\Delta f$ ) limit. Since 20-05/20-06 can not be changed in the process of operation, it is necessary to firstly stop the inverter and then reduce the ASR + / - limit.
- . Set as the figure 4.3.111, observe the motor speed waveform and tune the gain at the same time.

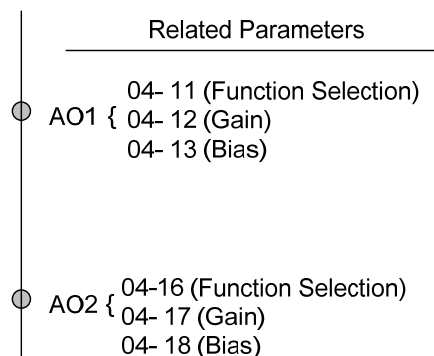

**Figure 4.3.111 Analog output setting**

d.ASR+/-limit (20-05, 20-06)

- . ASR +/-limit is the speed control of the frequency compensation limit. Set this frequency limit to the percentage of the maximum frequency output 01-02.
- If the frequency limit is over low, the actual motor speed may not reach the target speed.

## B. ASR setting (SV/SLV/PMSV control mode)

(1) SLV mode :

- . SLV mode is aimed at the high-speed and low-speed sections. The speed controller has a high-speed gain 20-00/20-01 and a low-speed gain 20-02/20-03 respectively for tuning. The switch between the high-speed and the low-speed will be set by 20-15 and 20-16.
- . Similar to the ASR gain, the speed estimate device has a high-speed gain 20-09/20-10 and a low-speed gain 20-11/20-12. The switch between the high-speed and the low-speed will be set by 20-15 and 20-16 too.
- . The speed estimate device has a low-pass filter to reduce the speed feedback interference. 20-13 and 20-14 are resectively defined as the low-pass filter time constant of the high speed and the low speed. The switch between the high-speed and the low-speed will be set by 20-15 and 20-16 too.
- . 20-17 sets the low-speed compensation gain of the speed feedback.
- . 20-18 sets the high-speed compensation gain of the speed feedback.
- . When the frequency referency is greater than the setting of 20-16, the high-speed ASR/estimatedevice gain and low-pass filter time constant will be fully provided.

When the frequency referency is less than the setting of 20-15, the high-speed ASR/estimatedevice gain and low-pass filter time constant will be fully provided. When the speed command drops in the range from 20-15 to 20-16, the gain the time constant will be switched linearly and smoothly.

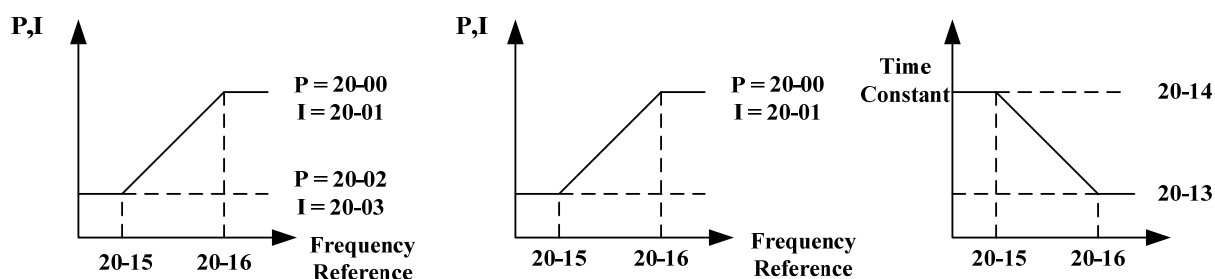

Figure 4.3.112 ASRgain setting of SLV mode

(2) SV and PMSV gain setting

- . SV and PMSV mode is aimed at the high-speed and low-speed sections. The speed controller has a high-speed gain 20-00/20-01 and a low-speed gain 20-02/20-03 respectively for tuning.

(3) Tune the speed control gain

- . For gain tuning, the multi-function analog output (AO1 and AO2 terminal) can be used to monitor the output frequency and motor speed (as shown in figure 4.3.112).

Full speed range gain tuning of SV and PMSV mode (20-00 - 20-03)

- . Complete the parameter tuning in normal operation.
- . Try to increase ASR proportional gain 1 (20-00), ASR proportional gain 2 (20-02), but be careful of the system shock.
  - 20-00, 20-02 can tune the response capacity of the speed control cycle.
  - Tuning the settings of 20-00, 20-02 can increase the system response, but it also may cause the system shock easily. Please refer to the following figure.

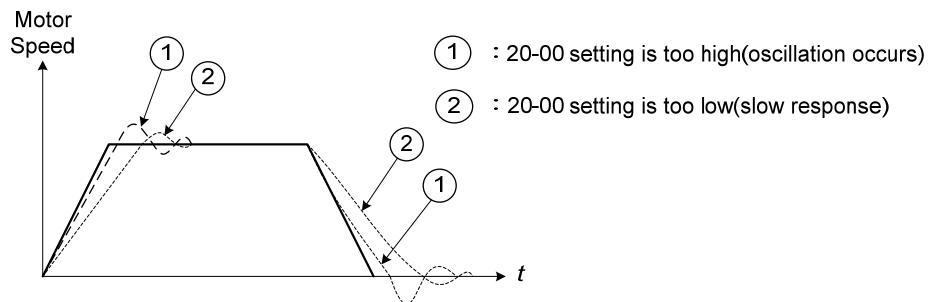

**Figure 4.3.113 System response of ASR proportion gain**

- . Reduce ASR integral time 1(20-01), ASR integral time 2 (20-02), but take care of the system shock.
- Relative long integral time will result in poor system response.
- If integral time setting is too short, the system easily results in shock. Please refer to the following figure.
- . In the process of PI gain tuning, the system overshoot occurs, the over voltage protection may occur. The braking unit (braking resistance) can be used to avoid this trouble.

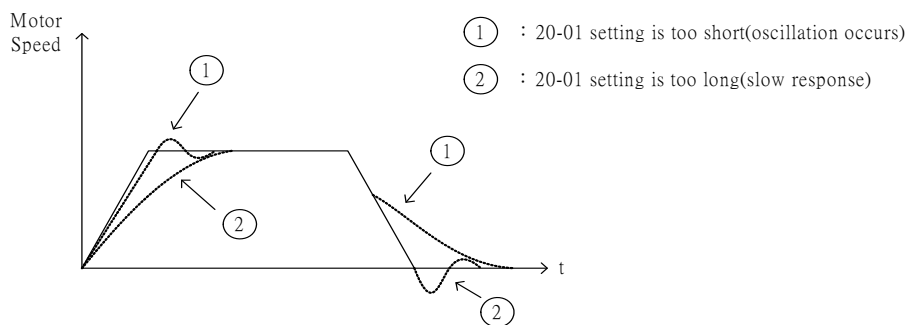

**Figure 4.3.114 The response of ASR integral time**

#### SLV mode gain tuning (20-00~20-03, 20-09~20-18)

- . Tune the low-speed ASR PI gain 20-02 ~ 20-03 at the reference speed, lower than 20-15. P gain and integral time tuning are similar to the 20-00 and 20-01 under SV mode.
- . Tune the high-speed ASR PI gain 20-00~20-01 at frequency reference, higher than 20-16. P gain and integral time are similar to the 20-00 and 20-01 under SV mode.
- . In general, the low-speed ASR gain and the high-speed gain can be the same. When the system shock occurs because of the mechanical resonance and other factors, you can tune the low-speed or high-speed gain for improvement. If tuning ASR PI gain 20-00~20-03 can not improve the problem of system response, reduce the low-pass filter time constant 20-13~20-14 to increase the bandwidth of the feedback system and re-tune ASR gain.
- . Tune low-speed low-pass filter time constant 20-14 at frequency reference, lower than 20-15.
- . Tune high-speed low-pass filter time constant 20-13 at frequency reference, higher than 20-16.
- . Increasing the low-pass filter time constant can limit the bandwidth of the speed feedback system and reduce the response of the whole system. Thus the speed feedback signal interference can be reduced, but it results in poor response to the momentary load. If the load is not significantly different and the steady operation is required, you can use this way for tuning. The low bandwidth of the speed feedback must be supported by the low gain of ASR to ensure the steady

operation.

- . Decreasing the low-pass filter time constant can increase the bandwidth of speed feedback and the response capacity of the whole system. Thus it can easily receive the interference signal of the speed feedback, but high capacity for the momentary load impact will be caused. If the load changes rapidly and quick response is required, it can be tuned by this way. The high bandwidth of the speed feedback allows relative high ASR gain.
- . If tuning 20-00 ~ 20-03 and low-pass filter time constant 20-13 can not obtain rapid response, tuning the PI gain 20-09 ~ 20-12 of the speed estimate device will be required.
- . The high gain of speed estimate (relative great proportion (P) gain and relative small integral (I) time) can accelerate the bandwidth of speed feedback, but it is also easily interfered, leading to the instability of the system.
- . The low gain of speed estimate (relative small proportion (P) gain and relative great integral (I) time) can decelerate the bandwidth of speed feedback, but it avoids the interference, leading to the stability of the system.
- . In general, the set value of ASR has met most of the applications. Adjusting the low pass filter time constant and the speed estimate are complex and risky in practice. Therefore, it is not recommend that users adjust them frequently. If getting a high-speed response and stable operation in SLV mode, SV mode can be used.
- . 20-15 defines the gain switch frequency of low-speed, while 20-16 defines the gain switch frequency of high-speed.
- . When the speed is lower than 20-15, the inverter will output a larger excitation current to make low-speed operation more accurate. When the frequency reference is greater than 20-16, the inverter will output the rated excitation current under the no-load voltage (02-19).
- . In general, 20-15 should be set at 5 ~ 50% of the motor basic frequency. If this set value is too high, the inverter output may be saturated. 20-16 should be set to 4Hz and higher than 20-08.
- . For the operation with heavy load (greater than 100%), if it is stable at middle speed but jitter at high speed, reduce the no-load voltage (02-19) or tune the FOC parameters (18-05 ~ 18-06).
- . 20-17 and 20-18 compensate speed feedback at low speed and high speed respectively.
- . Set 20-17 to adjust the no-load speed when it is lower than 2Hz. Tuning 20-17 is similar to add an offset to torque-speed curve. When the no-load speed is lower than the frequency reference, you can increase 20-17. When the no-load speed is higher the frequency reference, you can decrease 20-17. The impact on the torque-speed curve from 20-17 is shown as the following figure:

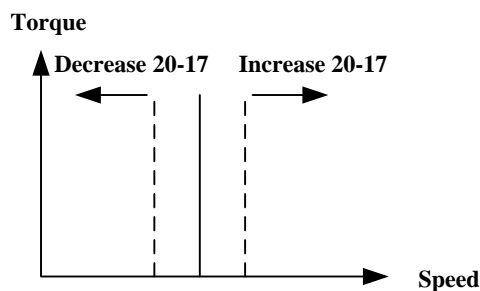
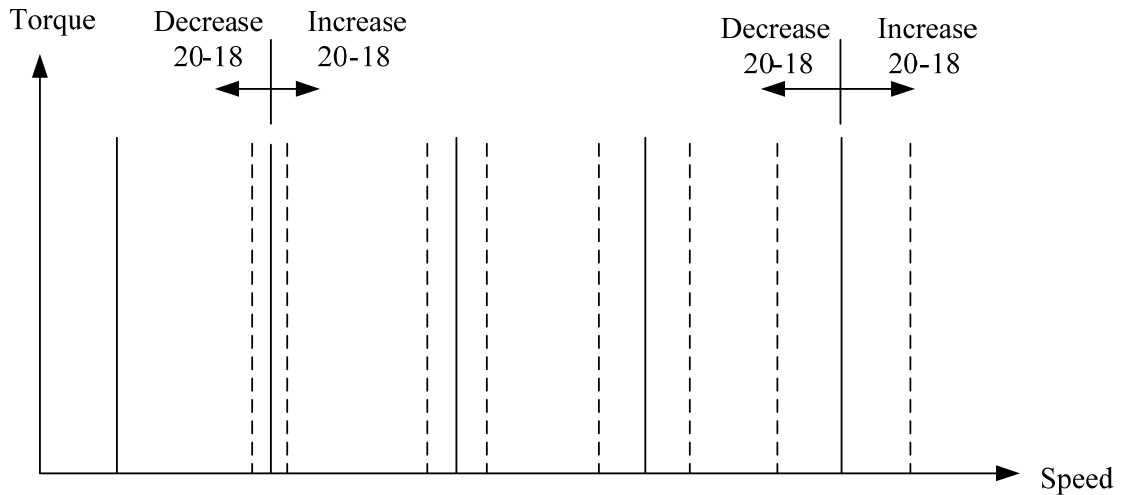

Figure 4.3.115 The impact on the torque-speed curve from 20-17

- . Set 20-18 to adjust the no-load speed of the middle and high speed range. In general, it is no need to tune. 20-18 is similar to 20-17, the torque-speed curve is shown as below:





**Figure 4.3.116 The impact on the torque-speed curve from 20-18**

- ①. ASR main delay time (20-08).
  - . It is no need to tune it usually.
  - . When the set value of 20-08 is relative high, the speed response will drop down, but the system shock does not easily occur.
- ②. ASR integral limit (20-04)
  - . Setting a relative small value may prevent the momentary change of the load.

<b>20- 19</b>	Over speed (OS) selection
<b>Range</b>	<b>【0】</b> : Deceleration to stop <b>【1】</b> : Coast to stop <b>【2】</b> : Continue to operate
<b>20- 20</b>	Over speed (OS) detection level
<b>Range</b>	<b>【0~120】</b> %
<b>20- 21</b>	Over speed (OS) detection time
<b>Range</b>	<b>【0.0~2.0】</b> Sec
<b>20- 22</b>	Speed deviation (DEV) selection
<b>Range</b>	<b>【0】</b> : Deceleration to stop <b>【1】</b> : Coast to stop <b>【2】</b> : Continue to operate
<b>20- 23</b>	Speed deviation (DEV) detection level
<b>Range</b>	<b>【0~50】</b> %
<b>20- 24</b>	Speed deviation (DEV) detection time
<b>Range</b>	<b>【0.0~10.0】</b> Sec
<b>20- 25</b>	Selection of PG Open
<b>Range</b>	<b>【0】</b> : Deceleration to stop <b>【1】</b> : Coast to stop <b>【2】</b> : Continue to operate
<b>20- 26</b>	Detection time of PG Open
<b>Range</b>	<b>【0.0~10.0】</b> Sec
<b>20- 27</b>	PG pulse number
<b>Range</b>	<b>【0~60000】</b> ppr
<b>20- 28</b>	Selection of PG rotation direction
<b>Range</b>	<b>【0】</b> : Forward as counter -clockwise rotation <b>【1】</b> : Forward as clockwise rotation
<b>20- 29</b>	PG pulse dividing ratio
<b>Range</b>	<b>【001~132】</b>

<b>20- 30</b>	PG gear ratio 1
<b>Range</b>	<b>【1~1000】</b>
<b>20- 31</b>	PG gear ratio 2
<b>Range</b>	<b>【1~1000】</b>

■PG card is required (PG-X3/PG-B3/PG-IPM)

PG pulse divider ratio can be set by 20-29.

■PG feedback setting

(1) Over speed operation setting (20-19 to 20-21).

- . When the motor operation exceeds the tuning limit, an error is detected.
- . If the motor speed feedback exceeds the set value of 20-20 (over-speed detection level) and set time of (over speed detection delay time), a failure detection of overspeed (OS) will be detected.
- . For over-speed (operating system) detection, the stop of the inverter is set by 20-19.

. For the block figure of PG feedback failure detection referring to the following figure 4.3.117.

(2) PG speed deviation setting (20-22 to 20-24).

- . When the speed deviation (namely the difference between the set speed and the actual motor speed) exceeds the tuning limit, an error will be detected.
- . If the speed deviation is greater than the set value of 20-23 (deviation detection level) or greater than time of 20-24 (deviation detection delay time), then the speed deviation (DEV) failure detection will be enabled (namely the output frequency is the reference frequency  $\pm$  the agreed width of frequency detection, 20-22).
- . If the speed deviation is detected, the inverter will stop according to the set of 20-22.
- . For the block figure of PG feedback failure detection referring to the below figure 4.3.117.

(3) PG detection setting (20-25 to 20-26).

- . If the PG (PGO) breaking-off failure is detected to exceed the set time of 20-26 (PG open circuit detection time).
- . The inverter will stop according to the set of 20-25
- . For the block figure of PG feedback failure detection, referring to the following figure 4.3.117,

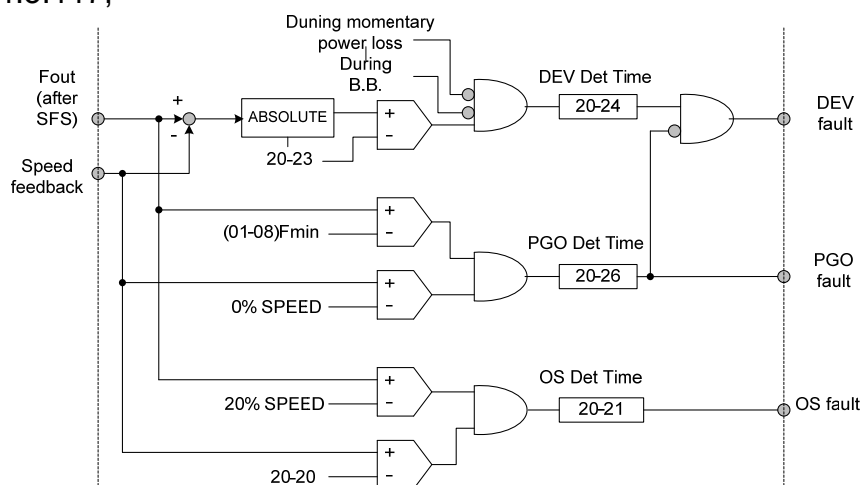
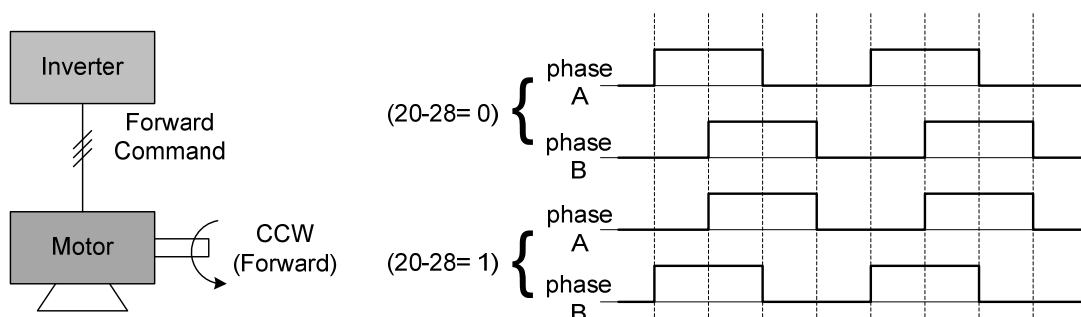

Figure 4.3.117 The block figure of PG feedback failure detection

- (4). Set PG pulse (20-27).
- . Set PG of pulse number of the encoder
  - . The pulse number of phase A or phase B for each cycle is set by parameter 20-27.
  - . If there is reduction gear between the motor and PG, the gear ratio will be set by 20-30 and 20-31.
- (5). PG rotation direction (20-28).
- . This parameter is used to set the motor direction and PG direction.
  - . For the motor forward operation, set that phase A or phase B is leading.
- 20-28=0: for forward operation, phase A is leading (namely phase B is leading for reversal operation).
- 20-28=1: for forward operation, phase A is leading (namely phase A is leading for reversal operation).



**Figure 4.3.118 PG and motor rotation direction signal**

Motor direction is determined as below:

- Forward: The motor operation is used for the inverter with special (counter-clockwise) direction to perform forward command. Refer to the below figure 4.3.119.

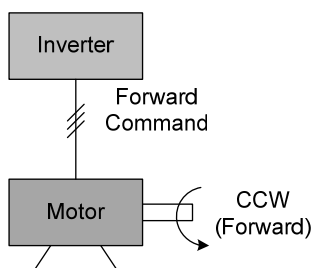

**Figure 4.3.119 Motor operation direction**

- Reversal: The motor operation is used for the inverter with clockwise direction to perform the command. Refer to the below figure 4.3.120 for typical PG signal.

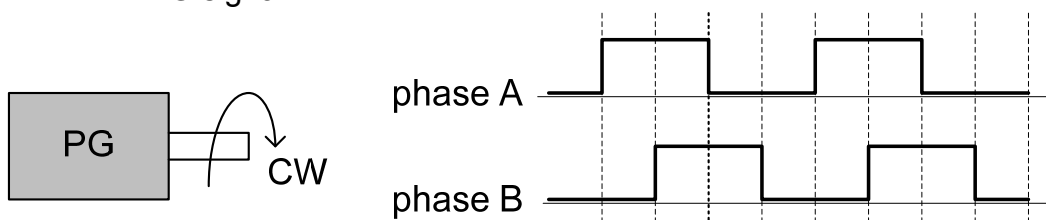

**Figure 4.3.120 PG operation direction**

(6) PG pulse dividing ratio (20-29).

When the pulse output signal is connected to a pulse input device. Use 20-29 to set the pulse divider ratio.

.Set 20-29 to present the first place n(0 or 1)as well as the second and the third place k (001 to 320).

The following formula uses n, k to calculate the output proportion of cycle.

– 20-29=  $\square\square\square$ , Setting range n : 0 to 1

n k k :01 to 32

– Output proportion =  $(1+n)/k$

e.g. 20-29=001 → n=0, k=1, proportion =  $(1+0)/1=1$

①. 20-29=032 → n=0, k=32, proportion =  $(1+0)/32=1/32$

②. 20-29=132 → n=1, k=32, proportion =  $(1+1)/32=1/16$

(7) Set the gear ratio of PG and motor (20-30,20-31).

. In V / F + PG control mode, there is transmission device between PG and the motor (the response speed of V / F + PG mode is less than that of SV mode).

. Set the gear ratio of the motor and PG as following:

– Set the gear ratio of the load side of 20-31.

–Set the gear ratio of the motor side of 20-30

–Motor speed will be calculated in accordance with the following formula:

$$\text{Motor Speed(RPM)} = \frac{\text{No. of input pulses from PG} \times 60}{\text{PG pulses (20-27)}} \times \frac{\text{No. of PG gear teeth 2 (20-31)}}{\text{No. of PG gear teeth 1 (20-30)}}$$

**21-Torque And Position Control Function Group**

<b>21- 00</b>	Torque control selection
<b>Range</b>	<b>【0】</b> : Speed control <b>【1】</b> : Torque control
<b>21- 01</b>	Filter time of torque reference
<b>Range</b>	<b>【0~1000】 mSec</b>
<b>21- 02</b>	Speed limit selection
<b>Range</b>	<b>【0】</b> : according AI input <b>【1】</b> : according to the set value of 21-03
<b>21- 03</b>	Speed limit value
<b>Range</b>	<b>【-120~120】 %</b>
<b>21- 04</b>	Bias voltage of speed limit
<b>Range</b>	<b>【0~120】 %</b>

(1) Torque control selection (21-00)

. In SV control mode, switch the speed and torque controls based on the following:

. Set one of multi-function digital input terminals from 03-00 to 03-08 to 44, (speed / torque control switching)

. When the input of this terminal is off, the speed control is enabled; when the input of this terminal is on, the torque control is enabled.

. Set 21-00 to select speed control or torque control

21-00= 0: speed control ( 20-00, 20-09), ASR setting

= 1: torque control (21-01 to 4), torque control setting

Refer to figure 4.3.108 for the speed control architecture. Refer to the below figure 4.3.121 for torque control architecture.

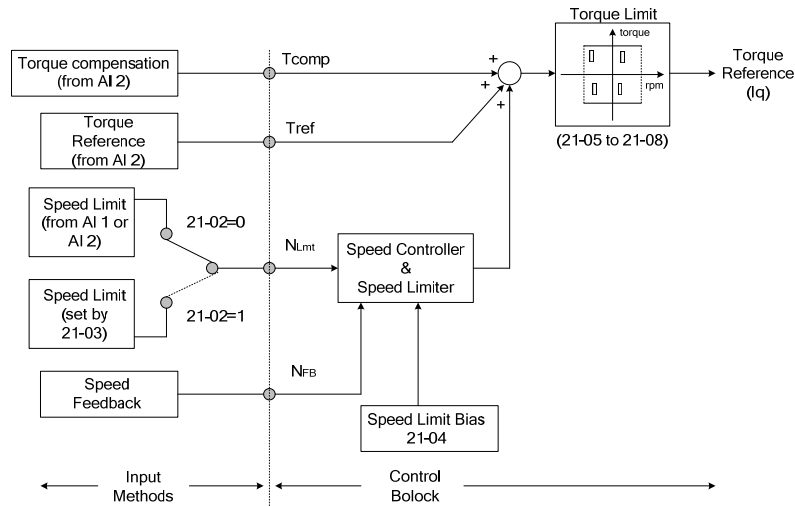

**Figure 4.3.121 Block figure of the torque control**

(2) Torque setting

(a) Torque command (Tref) input (AI2: 04-05).

. Torque command (Tref) can not be set by the digital operator. It can be adjusted by the multi-function analog input (AI2) through setting 04-05 (AI2 function selection) to 15 (torque) or 16 (torque compensation)

- The torque output direction of the motor depends on the minus or plus sign of the analog input signal (AI2) rather than depend on the direction of the operation command.
- Since the analog input signal AI2 determines the direction, the signal is positive voltage (or positive current), and a forward torque signal can be inputted. (Motor output shaft is counterclockwise).
- To use the function of the negative torque, it is required to set one parameter of multi-function digital inputs from 03-00 to 03-07 to 45 (negative torque command), and set the corresponding digital input terminal to ON. (Motor output shaft is in clockwise direction)

**Table 4.3.16 Torque input method**

Input method	Input terminal	Related parameter setting	Description
voltage input (0 - 10V)	AI2 (SW1-2=" V ")	04-00=0,2	Terminal AI2 signal level : 0 - 10V
		04-05=15	AI2 as torque input
current input (4 - 20mA)	AI2 (SW1-2=" I ")	04-00=1,3	Terminal AI2 signal level : 4 - 20mA
		04-05=15	AI2 as torque input

(3) Torque filter time (21-01).

Time constant is used to eliminate the interference of the torque signal and adjust the response.

If the system instability occurs in control period, increase the set value.

(4) Speed limit input setting (21-02 and 21-03) .

. If the external torque reference and the load are imbalance in the period of torque control, the motor will accelerate endlessly, and the speed limit function can be used to limit the motor speed to avoid damaging the system or the structure.

. There are two ways to set the speed limit, parameter setting or analog input setting. Refer to the following table 4.3.17 for the speed limit input method.

**Table 4.3.17 Speed limit input method**

Input method	Input terminal	Related parameter setting	Description	
1	Voltage input (-10V - 10V)	AI1	21-02=0	Analog input (AI1 or AI2) as speed limit
			00-05=1	Analog input (AI1 or AI2 is set by 04-05 ) as reference frequency input
			04-00=2,3	Terminal AI1 signal level : -10V - 10V (if the speed limit is plus value, set 04-00=0, 1)
	Voltage input (10V - 10V)	AI2 (SW2=" V ")	21-02=0	Analog input (AI1 or AI2) as speed limit
			00-05=1	Analog input (AI1 or AI2 is set by 04-05 ) as reference frequency input
			04-00=0,2	Terminal AI2 signal level : 0V - 10V
	Current input (4 - 20mA)	AI2 (SW2=" I ")	04-05=12	AI2 will be added to terminal AI1 as speed limit value
			21-02=0	Analog input (AI1 or AI2) as speed limit
			00-05=1	Analog input (AI1 or AI2 is set by 04-05 ) as reference frequency input
2	Parameter setting 21-03	-	04-00=1,3	Terminal AI2 signal level : 4 - 20mA
			04-05=12	AI2 will be added to terminal AI1 as speed limit value
			21-02=1	Set the speed limit to be controlled by 21-03
		21-03	Set speed limit	

- The rotation direction of speed control is depended on the speed limit signal:
  - .Positive voltage: Forward , speed limit (21-03+21-04).Reversal speed limit is zero or reversal direction (-21-04).
  - .Negative voltage: Reversal, speed limit (-21-03-21-04). Forward , speed limit is zero or forward direction (21-04) .
- If the speed limit bias is set to 0, the motor speed will be limited to 0 when the rotation direction of motor and the speed limit are reverse. For example, the speed limit signal is a positive voltage and the motor is forward operation, then the effective range of torque control is from 0 to the speed limit value of forward direction.

**(4) Speed limit bias setting (21-04).**

- .Speed limit bias (21-04) is used to adjust the boundary of the speed limit.
- .Speed limit bias (21-04) can set the forward and reversal direction of the motor to the same limit value.
- Set the percentage of the maximum output frequency (01-02) to the speed limit bias.

*Example 1- Set 30% of the forward and reverse speed limit*

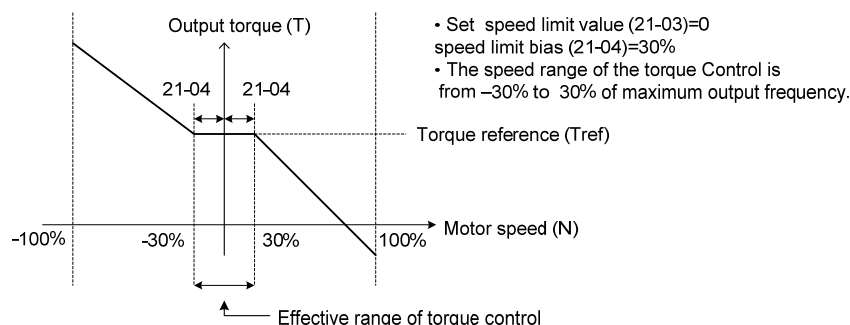

**Figure 4.3.122 Speed limit setting**

- Example 2 – Settings:*
1. Speed limit value (21-03) =100% (positive speed limit)
  2. Speed limit bias (21-04) =20%
- . The speed range of the torque control is from -20% (21-04) to 120% (21-03 +21-04)

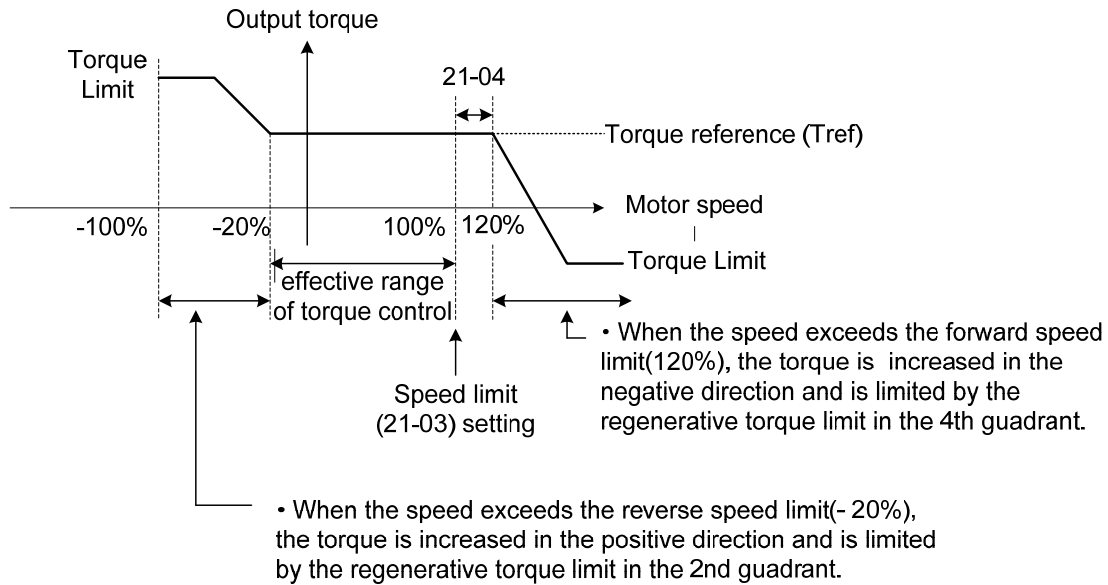

**Figure 4.3.123 Speed limit setting (Example 2)**

(5) The example of torque limit and speed limit operation

. Torque limit and speed limit are used in winding operation and roll-out operation in the example.

(a) Winding operation

. The line speed (N) and motor torque (T) are in the same direction generated by the motor. Refer to Figure 4.3.124

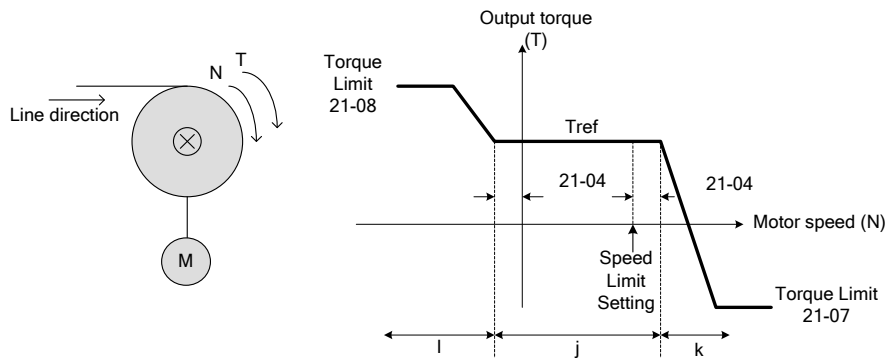

**Figure 4.3.124 Winding operation**

- ①: Speed limit bias (-21-04) > Motor Speed > speed limit bias (+21-04) → torque will be controlled according to Tref.
- ②: Motor speed (N) > speed limit bias +21-04 → speed limit will output negative torque to prevent the increase of motor speed.
- ③: Motor speed (N) < -21-04 → speed limit will output a forward torque to prevent the increase of speed.

(b) Roll-out operation

. The line speed (N) and motor torque (T) are in the opposite direction

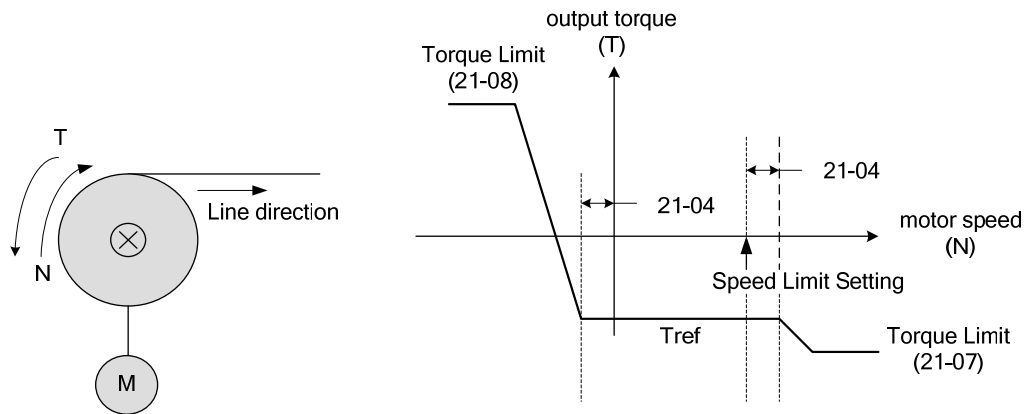

Figure 4.3.125 Roll-out operation

The relationship among Tref (torque reference), NLmt (speed limit) and N (motor speed) is shown as below when used in winding operation and roll-out operation.

Operations	Winding operation		Roll-out operation	
T-N curve				
Operation direction	Forward	Forward	Forward	Forward
Tref (Torque reference)	+	-	-	+
N <sub>Lmt</sub> (Speed limit)	+	-	+	-
Architecture				

Figure 4.3.126 Winding and roll-out operations

(6) Torque compensation setting (AI2 :04-07 and 04-08)

- . Torque compensation is added to the torque for torque loss, mechanical damage or other losses.
- . Set the multi-function analog input AI2 as the input compensation of torque (04-05 = 16).
- . Set appropriate signal level for the torque compensation. The torque compensation is determined by the signal polarity, not by the direction of the operation command. Tcomp is fixed as + voltage (or current), therefore it is the positive torque compensation (the rotation of motor shaft is counterclockwise).



<b>21- 05</b>	Positive torque limit
<b>Range</b>	<b>【0~300】 %</b>
<b>21- 06</b>	Negative torque limit
<b>Range</b>	<b>【0~300】 %</b>
<b>21- 07</b>	Forward regenerating torque limit
<b>Range</b>	<b>【0~300】 %</b>
<b>21- 08</b>	Reversal regenerating torque limit
<b>Range</b>	<b>【0~300】 %</b>

Set the torque limit function to limit the torque applied to the load, or limit the regenerating value.

. When the torque limit function is used, the priority of the torque control is higher than the motor speed control and the compensation. Therefore, the acceleration / deceleration time may be extended, and the motor speed may be reduced.

. There are two ways applied for torque limit:

Set the parameters used of the torque limit (21-05 to 21-08).

Set the torque limit by using the multi-function analog input (AI2).

(1) Set the parameters used of the torque limit (21-05 to 21-08).

. There are four torque limits can be set separately:

(I) Positive torque limit of forward side (21-05 positive torque limit)

(II) Positive torque limit of reversal side (21-06 negative torque limit)

(III) Negative torque limit of reversal side (21-07 forward regenerating torque limit)

(IV) Negative torque limit of forward side (21-08 reversal regenerating torque limit)

Refer to Figure 4.3.127.

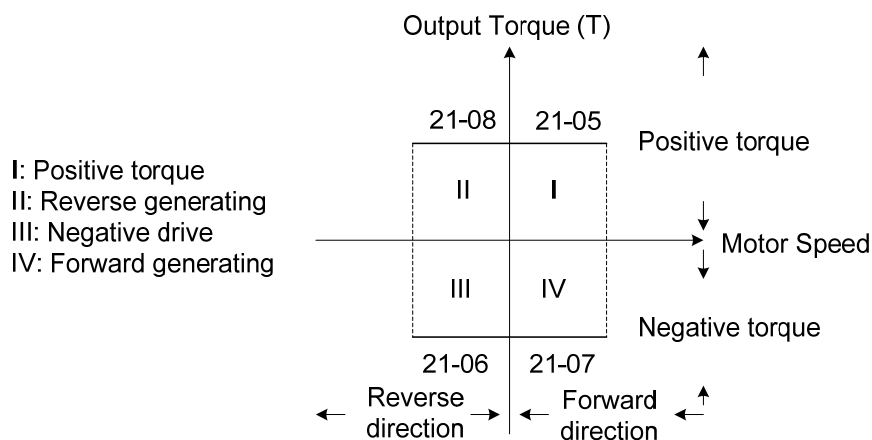

**Figure 4.3.127 Torque limit setting**

(2) Set the torque limit by using multi-function analog input (04-05)

. Multi-function analog input (AI2) can be used to limit the torque. Use any one of or both of setting parameters 04-07(AI2 function selection) for the input requirement. Refer to the table 4.3.18 below for setting the rated torque limit function.

**Table 4.3.18 Torque limit analog input**

04-05(AI2) setting	Function
11	Forward torque limit
12	Reversal torque limit
13	Regenerating torque limit (for both forward and reversal directions).
14	Positive/negative torque limit (positive and negative detection torque limit)

The set analog input terminal (AI2) signal level (04-00), gain (04-07) and bias (04-08) meet the actual input signal. The default setting of the analog input terminal signal level is shown as the following:

AI2 = 0 to 10V (10V input torque limit to 100% of the motor rated torque)

The figure 4.3.128 below is the relationship of the output torque and the torque limit

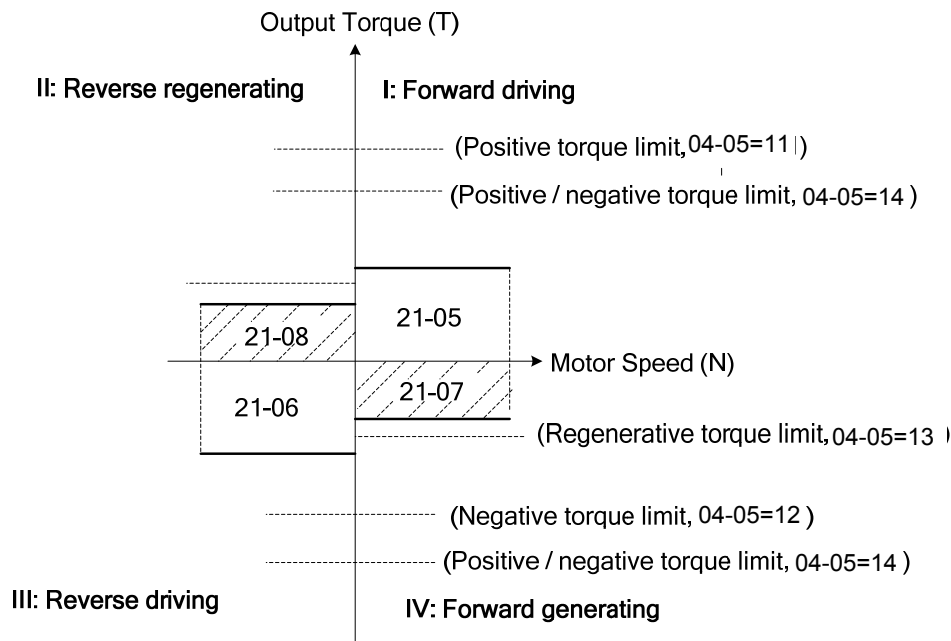

**Figure 4.3.128 Analog input torque limit (AI2)**

- When the forward torque limit has been set (set value = 11), the analog input signal is the forward torque limit value. When the torque is based on the rated forward direction, the forward torque limit input is valid even if the motor is operating in the reversal direction, (namely the regenerating torque is in the second quadrant).
- When the reversal torque limit has been set (set value = 12), the analog input signal is the reversal torque limit value. When the torque is based on the rated reversal direction, the reversal torque limit input is valid even if the motor is operating in the forward direction, (namely the regenerating torque is in the fourth quadrant).
- When the regenerating torque limit has been set (set value = 13), the analog input signal is forward (the fourth quadrant) or reversal (the second quadrant) regenerating area.
- When the forward / reversal torque limit has been set (set value = 14), the analog input signal is forward or reversal limit value.
- When the analog input is the maximum (10V or 20mA), the torque limit is 100% of the motor rated torque. In order to increase the torque limit above 100%, set the input terminal gain (04-07) above 100%. For example: 200.0% of the gain will

result in the torque limit of 200% of motor rated torque or a function analog input using 10V (20mA).

<b>21- 09</b>	Maximum frequency of position control
<b>Range</b>	<b>【0.1~100】 Hz</b>
<b>21- 10</b>	The command of rotation cycle number of section 0
<b>Range</b>	<b>【-9999~9999】</b>
<b>21- 11</b>	The command of the pulse number of section 0
<b>Range</b>	<b>【-9999~9999】</b>
<b>21- 12</b>	The command of rotation cycle number of section 1
<b>Range</b>	<b>【-9999~9999】</b>
<b>21- 13</b>	The command of the pulse number of section 1
<b>Range</b>	<b>【-9999~9999】</b>
<b>21- 14</b>	The command of rotation cycle number of section 2
<b>Range</b>	<b>【-9999~9999】</b>
<b>21- 15</b>	The command of the pulse number of section 2
<b>Range</b>	<b>【-9999~9999】</b>
<b>21- 16</b>	The command of rotation cycle number of section 3
<b>Range</b>	<b>【-9999~9999】</b>
<b>21- 17</b>	The command of the pulse number of section 3
<b>Range</b>	<b>【-9999~9999】</b>
<b>21- 18</b>	The command of rotation cycle number of section 4
<b>Range</b>	<b>【-9999~9999】</b>
<b>21- 19</b>	The command of the pulse number of section 4
<b>Range</b>	<b>【-9999~9999】</b>
<b>21- 20</b>	The command of rotation cycle number of section 5
<b>Range</b>	<b>【-9999~9999】</b>
<b>21- 21</b>	The command of the pulse number of section 5
<b>Range</b>	<b>【-9999~9999】</b>
<b>21- 22</b>	The command of rotation cycle number of section 6
<b>Range</b>	<b>【-9999~9999】</b>
<b>21- 23</b>	The command of the pulse number of section 6
<b>Range</b>	<b>【-9999~9999】</b>
<b>21- 24</b>	The command of rotation cycle number of section 7
<b>Range</b>	<b>【-9999~9999】</b>
<b>21- 25</b>	The command of the pulse number of section 7
<b>Range</b>	<b>【-9999~9999】</b>
<b>21- 26</b>	The command of rotation cycle number of section 8
<b>Range</b>	<b>【-9999~9999】</b>
<b>21- 27</b>	The command of the pulse number of section 8
<b>Range</b>	<b>【-9999~9999】</b>
<b>21-28</b>	The command of rotation cycle number of section 9
<b>Range</b>	<b>【-9999~9999】</b>
<b>21- 29</b>	The command of the pulse number of section 9
<b>Range</b>	<b>【-9999~9999】</b>
<b>21- 30</b>	The command of rotation cycle number of section 10
<b>Range</b>	<b>【-9999~9999】</b>
<b>21- 31</b>	The command of the pulse number of section 10
<b>Range</b>	<b>【-9999~9999】</b>
<b>21- 32</b>	The command of rotation cycle number of section 11
<b>Range</b>	<b>【-9999~9999】</b>

<b>21- 33</b>	The command of the pulse number of section 11
<b>Range</b>	<b>【-9999~9999】</b>
<b>21- 34</b>	The command of rotation cycle number of section 12
<b>Range</b>	<b>【-9999~9999】</b>
<b>21- 35</b>	The command of the pulse number of section 12
<b>Range</b>	<b>【-9999~9999】</b>
<b>21- 36</b>	The command of rotation cycle number of section 13
<b>Range</b>	<b>【-9999~9999】</b>
<b>21- 37</b>	The command of the pulse number of section 13
<b>Range</b>	<b>【-9999~9999】</b>
<b>21- 38</b>	The command of rotation cycle number of section 14
<b>Range</b>	<b>【-9999~9999】</b>
<b>21-39</b>	The command of the pulse number of section 14
<b>Range</b>	<b>【-9999~9999】</b>
<b>21- 40</b>	The command of rotation cycle number of section 15
<b>Range</b>	<b>【-9999~9999】</b>
<b>21- 41</b>	The command of the pulse number of section 15
<b>Range</b>	<b>【-9999~9999】</b>

Function description:

Maximum frequency for position control(21-09):search the maximum frequency for the next positioning point in the Multi-position positioning function.

Multi-position positioning function deceleration time is set to 00-15 deceleration time 1.

In the SV control mode, use multi-function digital input terminals from 03-00 to 03-07.

The selection of function setting is shown as the following table 4.3.19.

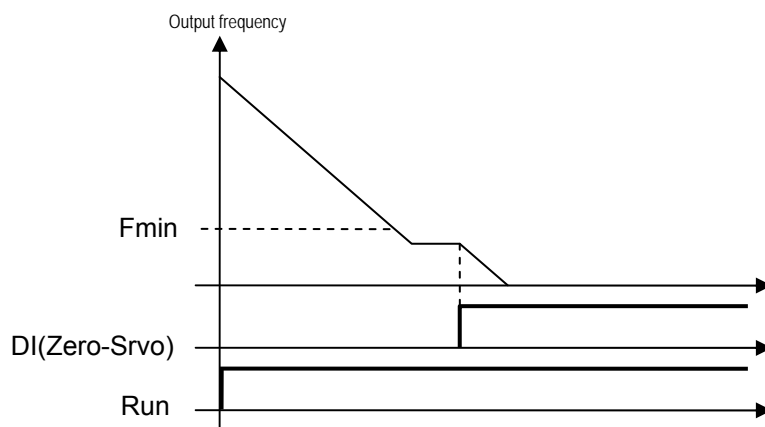

Figure 4.3.129 Sketch diagram of zero-servo positioning

Table 4.3.19 Multi-position positioning function setting

<b>03-00~03-07 (DI fun) setting</b>	<b>Function</b>
02	Multi-speed/position setting command 1
03	Multi-speed/position setting command 2
04	Multi-speed/position setting command 3
05	Multi-speed/position setting command 4
46	Zero-Servo command
51	Mode switching between speed and position

The description of Multi-position positioning function (MultiPosRef):

1. Zero-servo positioning function (Zero-Srvo):

Arbitrary origin positioning function: when the frequency is lower than Fmin and it is Zero-Servo input in operation, the current position of motor is the origin and it enters the zero-servo positioning mode (Zero-Srvo). Positioning command

PosRef is origin, as shown in figure 4.3.129.  
 For the setting of motor position loop, please refer to 11-49.  
 For the setting of motor speed loop, please refer to 20-00 and 20-01.

## 2. Multi-position positioning function (MultiPosRef)

After inputting external positioning command trigger (MultiPosRefEn) in the zero-servo positioning mode (Zero-Srvo), multi-speed command 1~4 will be changed into multi-position positioning command 1~4.

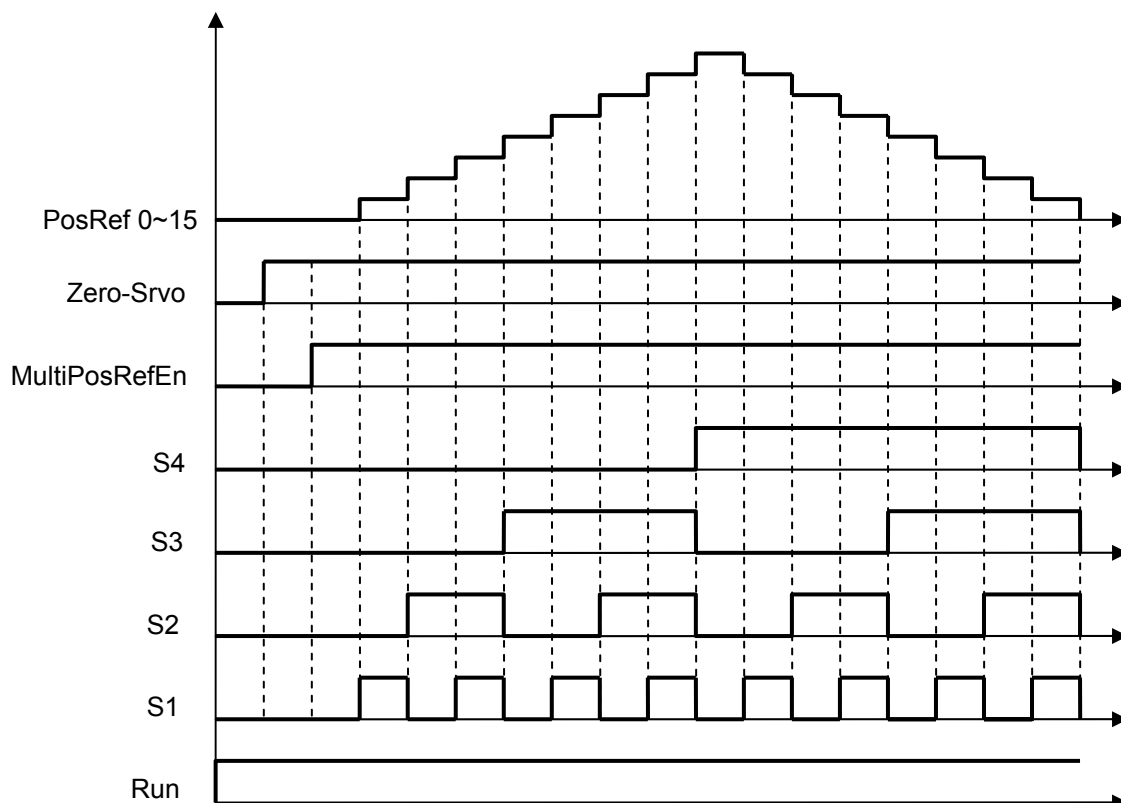

**Figure 4.3.130 Sketch diagram of Multi-position positioning function**

Position setting description of positioning:

For the direction of motor rotation, please refer to 20-28

Command of rotating a circle = command of pulse number

Position = Command of cycles + Command of pulse number

For example, the motor encoder is 1024 PPR

Make the motor rotate forwardly for a semi-circle, the command of rotation cycle is set to 0, and the command of the pulse number is set to 512 ( $1/2 * 1024$ ).

Mke the motor rotate reversally one and three fourth cycles, the command of rotation cycle is set to -1, the pulse number is set to -768 ( $-3/4 * 1024$ ).

## 22- IPM Motor Parameter Group

<b>22- 00</b>	PM motor rated power
<b>Range</b>	<b>【0.00~600.00】 Kw</b>
<b>22- 01</b>	PM motor rated voltage
<b>Range</b>	<b>【50~240】 V:220V</b> <b>【100~480】 V:440V</b>
<b>22- 02</b>	PM motor rated current
<b>Range</b>	25%~200% inverter's rated current
<b>22- 03</b>	PM motor's pole numver
<b>Range</b>	<b>【2~96】 Poles</b>
<b>22- 04</b>	PM Motor's rated rotation speed
<b>Range</b>	<b>【0~60000】 rpm</b>
<b>22- 05</b>	PM motor's maximum rotation speed
<b>Range</b>	<b>【0~60000】 rpm</b>
<b>22- 06</b>	PM motor rated frequency
<b>Range</b>	<b>【0.0~400.0】 Hz</b>

PM motor's parameter setting is shown as below. This parameter group can restore the default value by the set parameter (13-08). Before initialization, please firstly confirm the models of parameter (13-00) and ensure there is not mistake.

- (01) PM motor rated power (22-00)  
Set the power value on the motor nameplate.
- (02) PM motor rated voltage (22-01)  
Set the voltage of full load on the motor nameplate.
- (03) PM motor rated current (22-02)  
Set the current of full load on the motor nameplate.
- (04) PM motor pole numver (22-03).  
Set the motor pole number to the one on motor nameplate.
- (05) PM motor rated speed (22-04)  
It is need to set one of 22-04 or 22-06 only, the program will automatically calculate the other one. The calculation formula is shown as below:  
 $n(22-04) = 120 * f(22-06) / P(22-03)$
- (06) PM motor maximum rotation speed (22-05)  
Set the motor rotation speed on the nameplate.
- (07) PM motor rated frequency (22-06)  
Set the motor frequency on the nameplate.

<b>22- 16</b>	Offset angle of the magnetic pole and PG origin
<b>Range</b>	<b>【0~360】 deg</b>
<b>22- 17</b>	PM motor tuning
<b>Range</b>	<b>【0】 : None</b> <b>【1】 : Magnetic pole alignment and loop adjustment</b> <b>【2】 : Magnetic pole alignment</b>
<b>22- 18</b>	Fault history of PM motor tuning

<b>Range</b>	<b>【0】</b> : No error <b>【1】</b> : Static magnetic alignment fault. <b>【2】</b> : Without PG option card <b>【3】</b> : Rotation pole alignment is forced to stop <b>【4】</b> : Rotation pole alignment is time-out. <b>【5】</b> : Loop adjustment is time out <b>【6】</b> : Encoder error <b>【7】</b> : Other error of motor tuning <b>【8】</b> : Current abnormality occurs when aligning rotation magnetic pole <b>【9】</b> : Current abnormality occurs while loop adjustment <b>【10】</b> : Restart magnetic pole alignment and loop adjustment
--------------	--

(8) Offset angle of magnetic pole and PG origin (22-16)

After the completion of magnetic pole realignment, the compensation amount for the origin will be stored to this parameter.

Note: it is not recommended users to modify this parameter

(9) PM motor tuning (22-17)

Warning! It may cause personal accident due to sudden start of the motor when performing motor tuning. Therefore, before performing the magnetic pole realignment, please firstly confirm the motor's mechanical load and the surrounding situation.

Warning! For PM motor tuning, it should be in power-on state. Touching the motor might result in electric shock. Therefore, before performing the magnetic pole realignment, please don't touch the motor.

Warning! In the state of the motor connecting or the brake device braking, do not tune the PM motor. Otherwise, it will result in bad action of the inverter. When performing magnetic pole realignment on the motor with load, the motor parameter improperly calculated might occur. Please disconnect the motor and the load and confirm that the motor can operate smoothly.

1. Before selecting PM motor tuning, please input motor information (22-00) - (22-06) and the number of encoder pulse (20-27) according to the motor nameplate.
2. Select 1, 2, or 3 for 22-17, and press ENTER, and then you can enter the PM motor tuning screen. The operator will display the message of "IPrdy". Press RUN to start the PM motor tuning, and the operator will display the message of "IPtun ". If the motor is successfully tuned, the message of "IPEnd " will be display. If the process of the PM motor tuning is interrupted by pressing STOP, the operator will display the message of " IPbrd "(PM motor tuning interrupted).

Note: 1. The inverter should be firstly performed with the magnetic pole alignment before the loop adjustment.

2. If the inverter has been performed with the magnetic pole alignment, you do not need to do magnetic pole alignment again when the power is resupplied.

(10) Fault history of PM motor tuning (22-18)





If the PM motor tuning is failed, the message of "IPErr" (PM motor tuning failure) will be displayed; the error reasons and the troubleshooting can be referred to section five.

Note: PM motor tuning failure history (22-18) only records the automatic tuning result of the last time. If the tuning is given up or successful, no error will be displayed.

## 4.4 Description Of Built-in PLC Function



For A510, the ladder program can be downloaded through TECO's drive link, a simple built-in PLC function can be established.

### 4.4.1 Basic command

				P			NO / NC
Input command					I	i	I1~I8 / i1~i8
Output command	Q	Q	Q	Q	Q	q	Q1~Q2 / q1~q2
Auxiliary command	M	M	M	M	M	m	M1~MF / m1~mF
Special buffer							V1~V7
Counter command	C				C	c	C1~C8 / c1~c8
Timer command	T				T	t	T1~T8 / t1~t8
Analog comparison command	G				G	g	G1~G8 / g1~g8
Operation control command	F				F	f	F1~F8 / f1~f8
Addition and subtraction command	AS						AS1~4
Multiplication and division command	MD						MD1~4

#### Description of special buffer

V1: Set frequency	Range : 0.1~1200.0Hz
V2: Operation frequency	Range : 0.1~1200.0Hz
V3: AI1 input value	Range : 0~1000
V4: AI2 input value	Range : 0~1000
V5: Keypad input value	Range : 0~1000
V6: Operation current	Range : 0.1~999.9A
V7: Torque value	Range : 0.1~200.0%

	Upper Differential	Lower Differential	Other command symbol
Differential command	D	d	
SET command			
RESET command			
P command			P

Open circuit	“ ”	
Short circuit	“--”	

Connection symbol	Definition
—	To connect coponents on the left and right sides
⊥	To connect coponents on the left and right as well as upper sides
⊕	To connect coponents on the left and right as well as upper and lower sides
⊔	To connect coponents on the left and right as well as lower sides



## 4.4.2 Basic command function

### ◎ D (d) command function

Example 1: I1-D — [ Q1

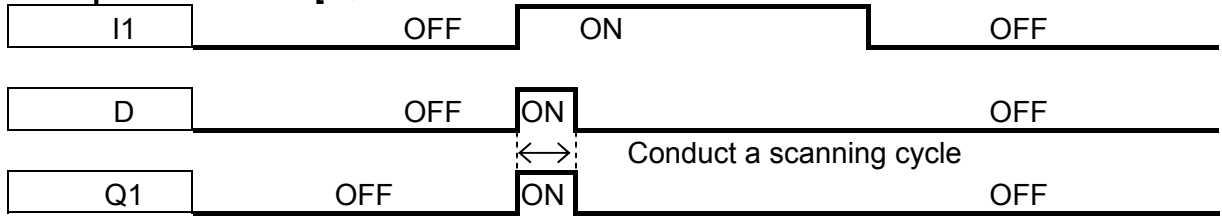

Example 2: i1-d — [ Q1

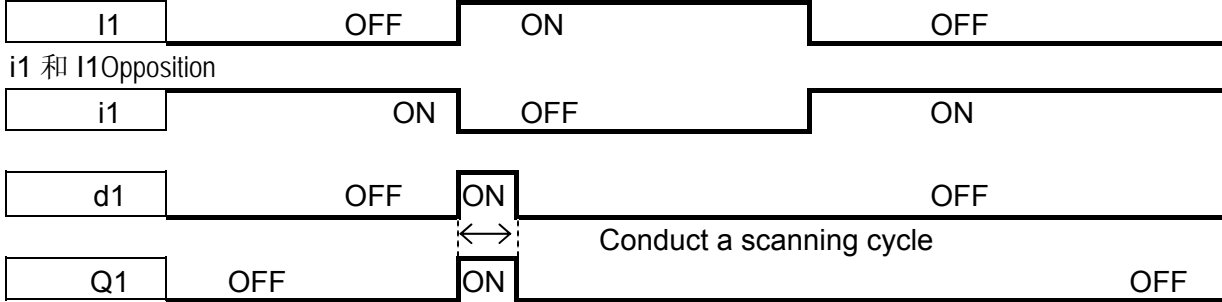

### ◎ NORMAL( -[ ) output

I1 — [ Q1

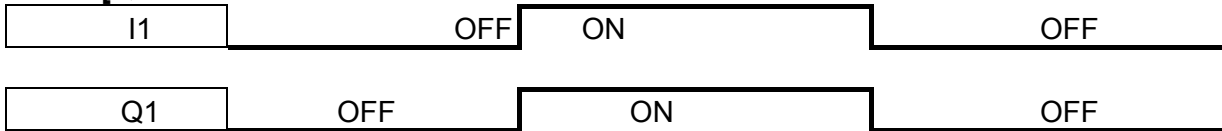

### ◎ SET ( ^ ) output

I1 — ^ Q1

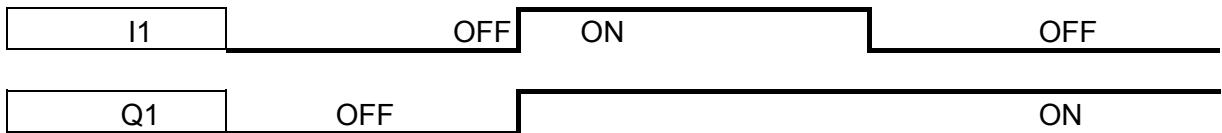

### ◎ RESET ( v ) output

I1 — v Q1

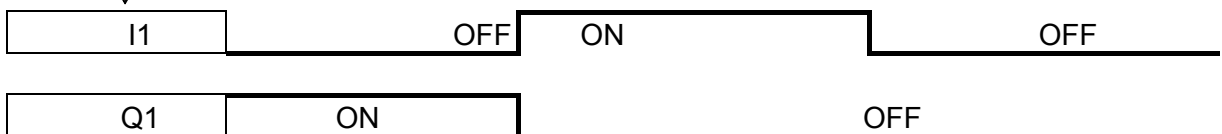

### ◎ P output

i1 — PQ1

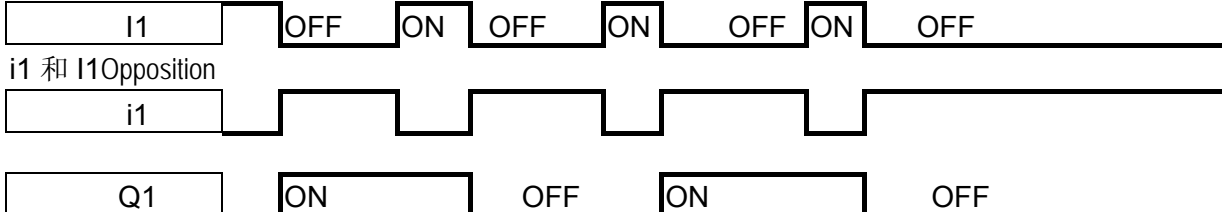

### 4.4.3 Application command

#### 1. Counter

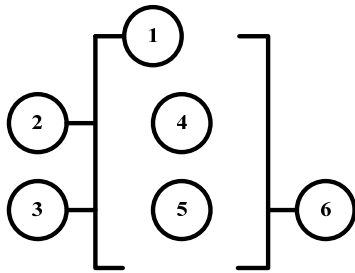

①	Counting mode (1-4)
②	UP/Down counting modes can be set by (l1 ~ f8).
	OFF:Up counting (0,1,2,3...)
	ON: Down counting(...3,2,1,0)
③	Use (l1~f8) to reset counting value
	ON : Count value resets and ⑥ is OFF
	OFF : Count value keeps on counting
④	Present counting value of the counter
⑤	Counter setting action values (AS1~AS4,MD1~MD4,T1~T8,C1~C8,V1~V7,constant)
⑥	Counter number (from C1 to C8, there are 8 groups in total)

The description of counting mode:

mode 1:

Count value is locked to the set value. The value will not be retained when the power is cut off.

mode 2:

Count value is not locked. The value will not be retained when the power is cut off.

mode 3:

Count value is locked. The value will be retained when the power is cut off.

mode 4:

Count value is not locked. The value will be retained when the power is cut off.

#### (1) Counter mode 1

**Example :**

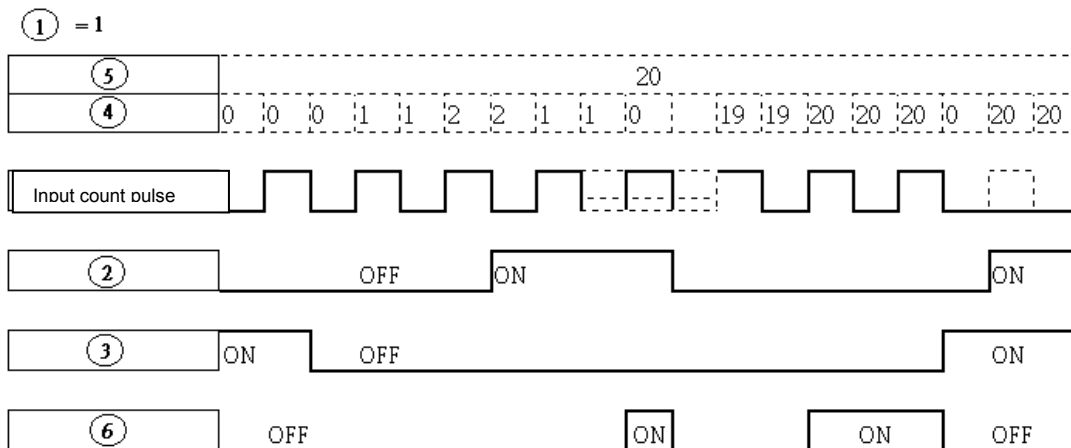

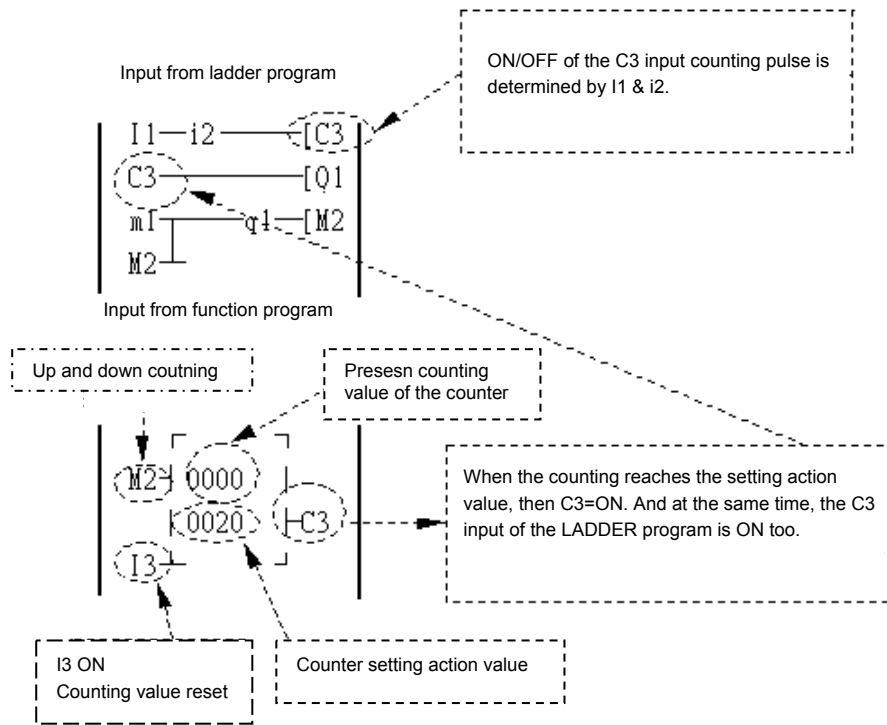

## (2) Counter mode 2

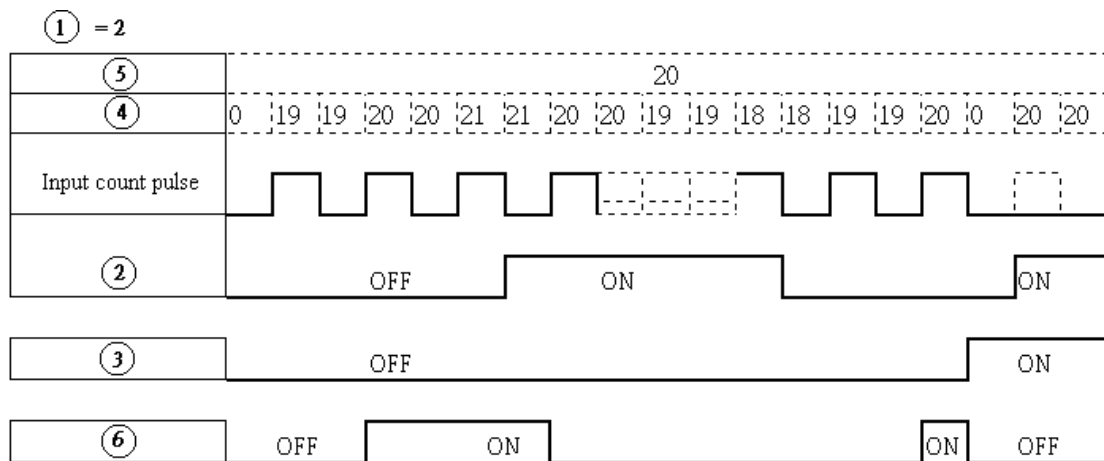

※**Note:** In this mode, the count value will be greater than 20, which is not similar to the mode 1 that the count value of mode 1 will be locked to 20.

- (1) Counter mode 3 is similar to the mode 1. But the present counting value of mode 3 will be retained when the power is cut off. When the power is resupplied, it counts from the present value.
- (2) Counter mode 4 is similar to the mode 2. But the present counting value of mode 4 will be retained when the power is cut off. When the power is resupplied, it counts from the present value.

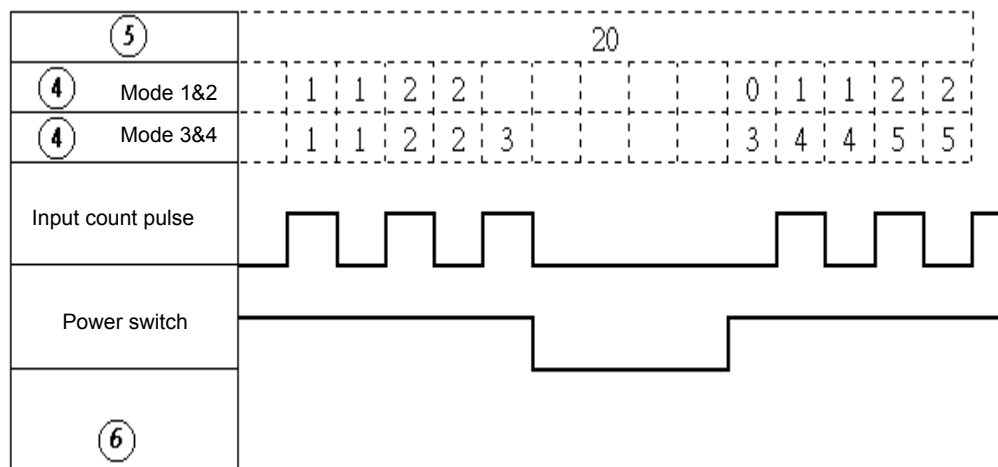

## 2.Timer

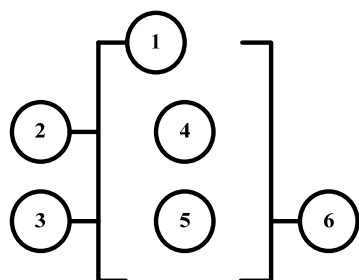

Symbol	Description
①	Timing mode (1-7)
②	Timing unit: 1: 0.0~999.9 second 2: 0~9999 second 3: 0~9999 minute
③	Use (I1~f8) to reset timing value ON : Timing value resets and ⑥ is OFF. OFF: Timing value keeps on timing.
④	Current timing value of the timer.
⑤	Timer setting action value (AS1~AS4,MD1~MD4,T1~T8,C1~C8,V1~V7,constant)
⑥	Timer number (from T1 to T8, there are 8 groups in total)

## Description of the timer mode:

### (1) Timer mode 1(ON-delay Timer mode 1)

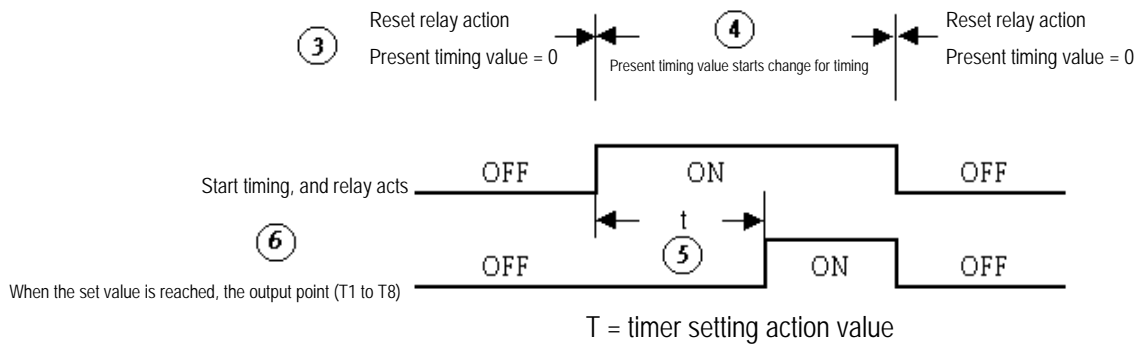

### Example:

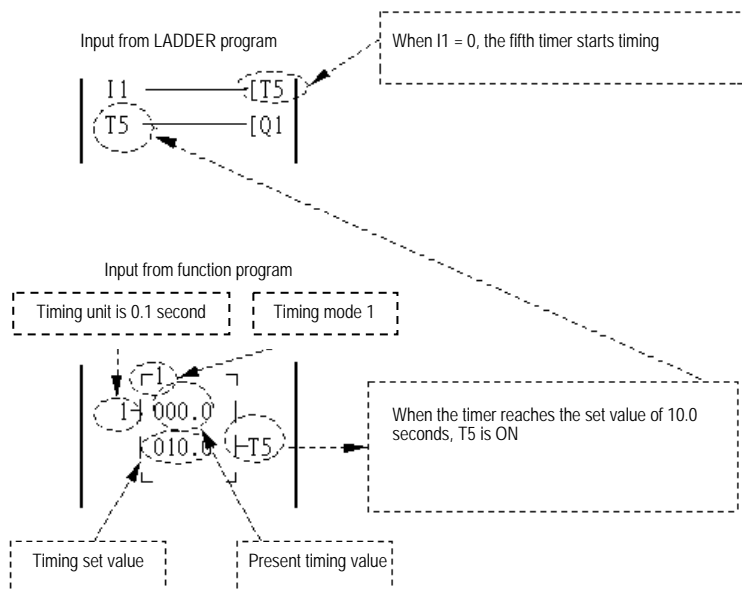

### (2) Timer mode 2(ON-dealy Timer mode 2)

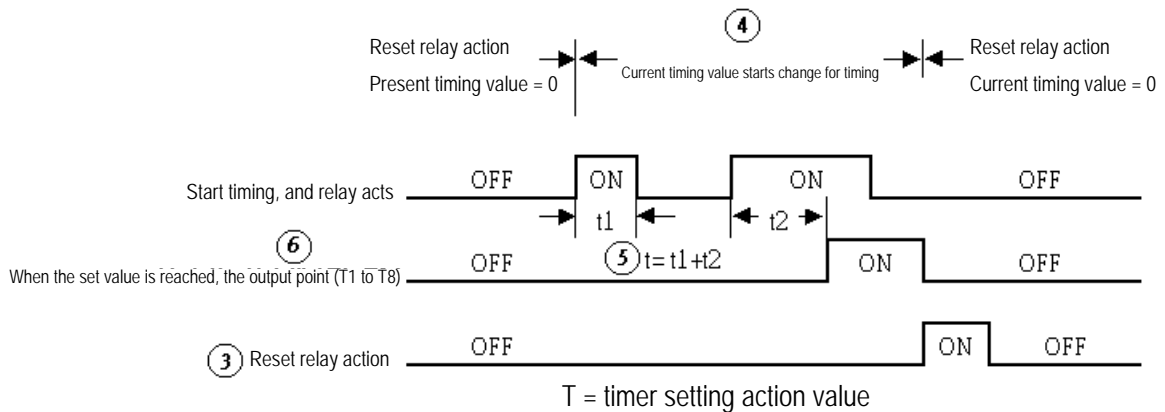

### (3) Timer mode 3 (OFF-delay Timer mode 1)

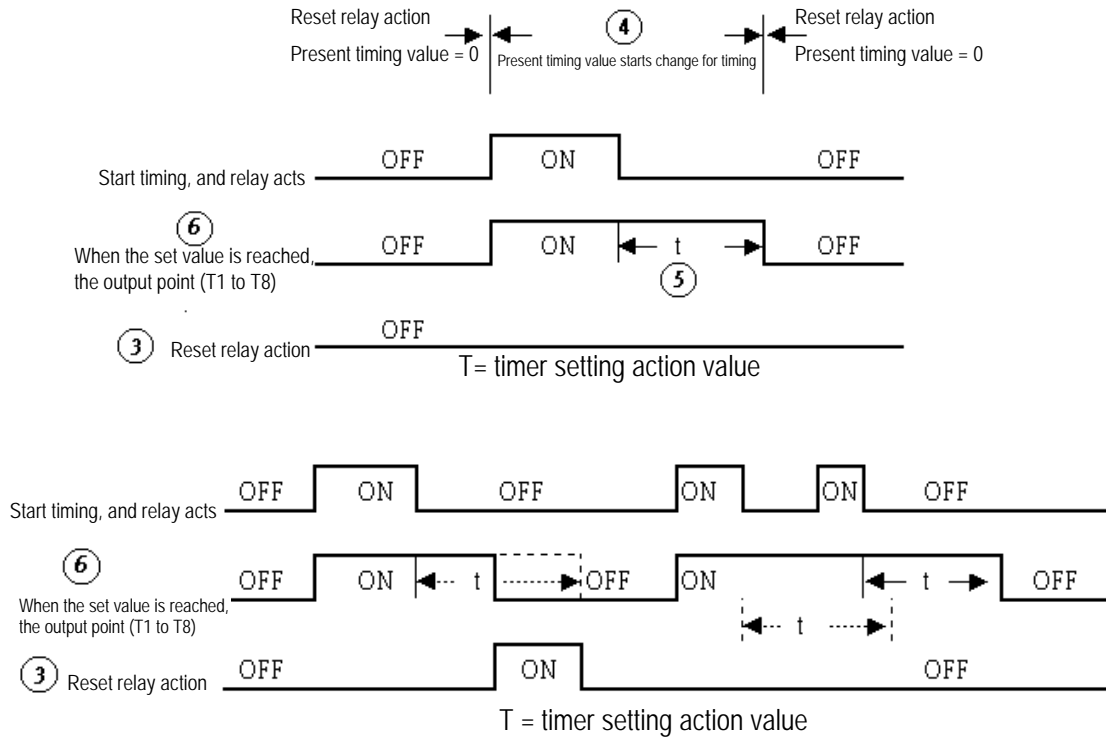

### (4) Timer mode 4 (OFF-delay Timer mode 2)

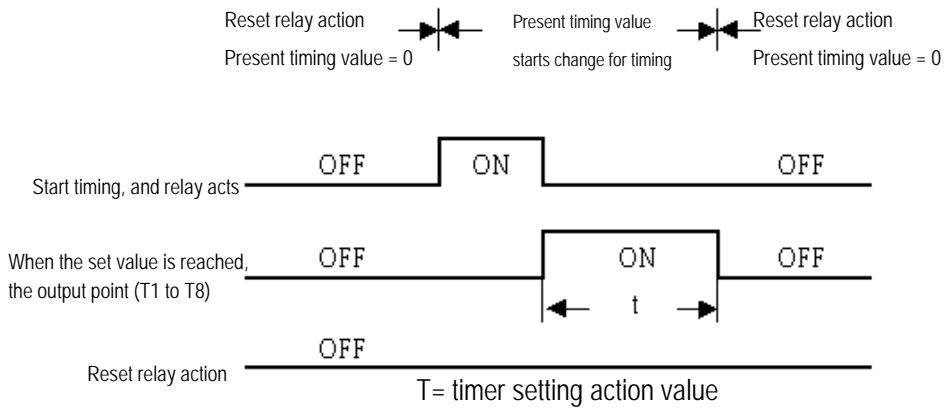

### (5) Timer mode 5 (FLASH Timer mode 1)

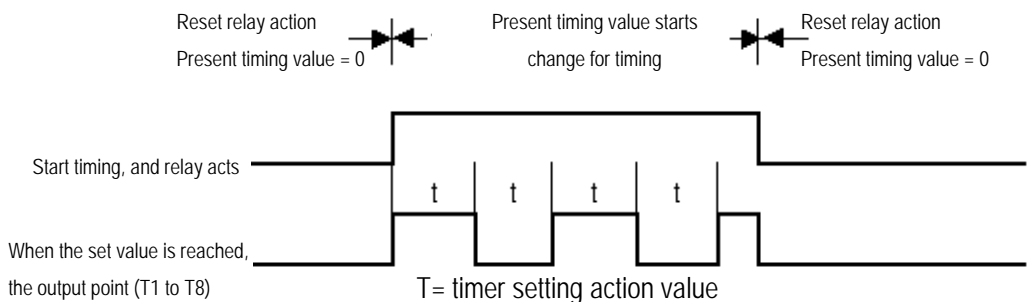

**(6) Timer mode 6 (FLASH Timer mode 2)**

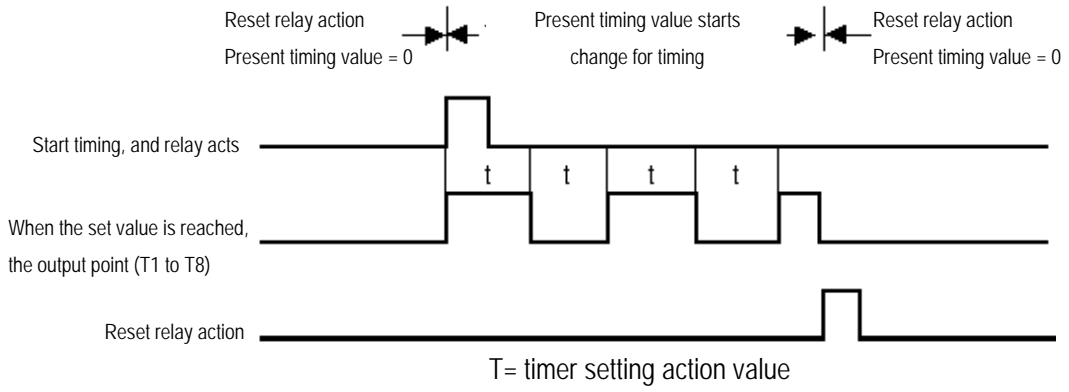

**(7) Timer mode 7 (FLASH Timer mode 3)**

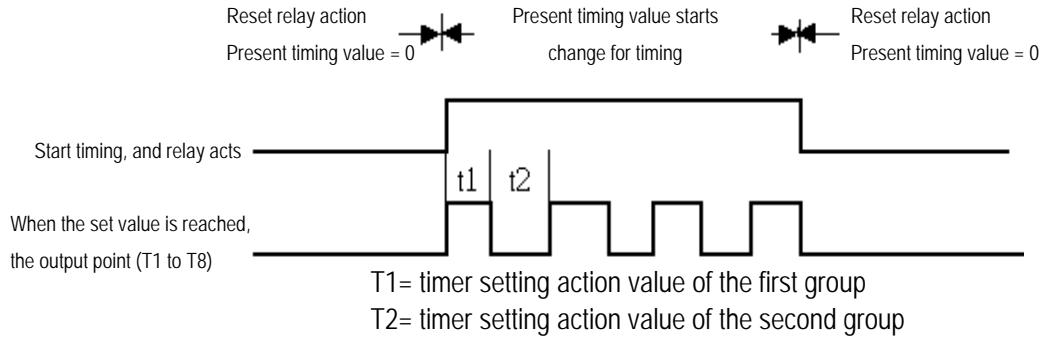

### 3. Analog comparator

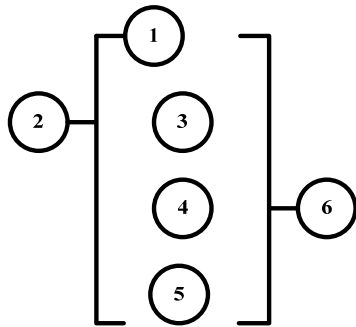

Symbol	Description
①	Analog comparison mode (1~3)
②	Input comparison value selection (AS1~AS4,MD1~MD4,T1~T8,C1~C8,V1~V7)
③	Present analog input value
④	Set the reference comparison value (Upper limit) (AS1~AS4,MD1~MD4,T1~T8,C1~C8,V1~V7, constant )
⑤	Set the reference comparison value (lower limit) (AS1~AS4,MD1~MD4,T1~T8,C1~C8,V1~V7, constant )
⑥	Output point of the analog comparator (G1~G8)

#### The description of analog comparison mode:

- (1) Analog comparison mode 1 (③ ≤ ⑤, ⑥ ON)
- (2) Analog comparison mode 2 (③ ≥ ④, ⑥ ON)
- (3) Analog comparison mode 3 (⑤ ≤ ③ ≤ ④, ⑥ ON)

#### Input comparison value selection (V1~V7)

- (1) Input comparison value selection = V1: Set frequency
- (2) Input comparison value selection = V2: Operation frequency
- (3) Input comparison value selection = V3: AI1 input value
- (4) Input comparison value selection = V4: AI2 input value
- (5) Input comparison value selection = V5: keypad input value
- (6) Input comparison value selection = V6: Operation current
- (7) Input comparison value selection = V7: Torque value



## 4. Operation control command

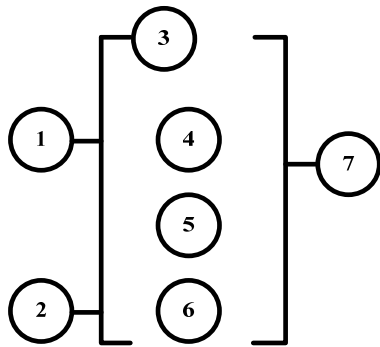

Symbol	Description
①	Forward /Reversal control can be set by ( I1~f8 ) OFF: Forward(FWD) ON: Reversal(REV)
②	Speed terminal control can be set by ( I1~f8 ) OFF: Operation based on ③ set frequency ON: Operation based on frequency of speed ④
③	Set frequency (can be constant or V3、 V4, V5 )
④	Speed frequency (can be constant or V3、 V4, V5)
⑤	Acceleration time (ACC Time)
⑥	Deceleration time (DEC Time)
⑦	Operation control command number (FROM F1 TO F8, THERE ARE 8 GROUPS IN TOTAL.)

### Example:

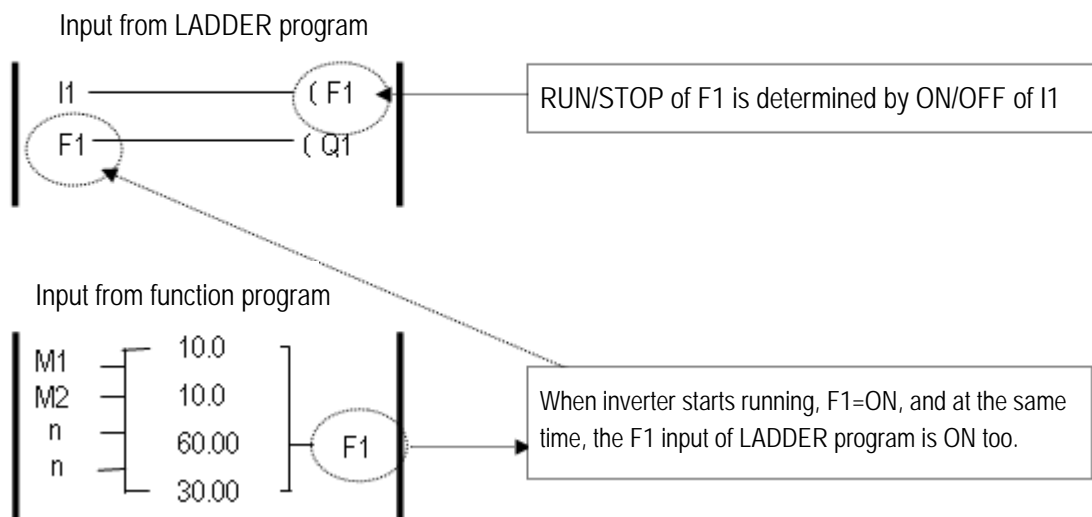

## 5. Addition and subtraction modes

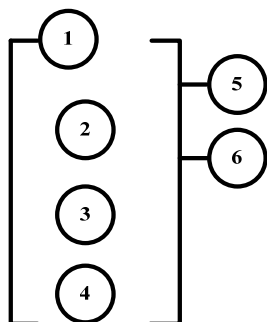

RESULT ( calculation result ) = V1+ V2- V3

Symbol	Description
①	calculation result : RESULT
②	Addend V1(AS1~AS4,MD1~MD4,T1~T8,C1~C8,V1~V7, constant )
③	Addend V2(AS1~AS4,MD1~MD4,T1~T8,C1~C8,V1~V7, constant )
④	Subtrahend V3(AS1~AS4,MD1~MD4,T1~T8,C1~C8,V1~V7, constant )
⑤	Coil output of error signal (M1~MF)
⑥	Addition and subtraction modes number (AS1~AS4)

## 6. Multiplication and division modes

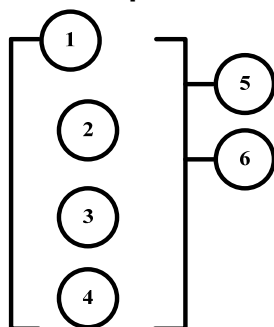

RESULT ( calculation result ) =V1\*V2/V3

Symbol	Description
①	calculation result : RESULT
②	Multiplier V1(AS1~AS4,MD1~MD4,T1~T8,C1~C8,V1~V7, constant )
③	Multiplier V2(AS1~AS4,MD1~MD4,T1~T8,C1~C8,V1~V7, constant )
④	Divisor V3(AS1~AS4,MD1~MD4,T1~T8,C1~C8,V1~V7, constant )
⑤	Coil output of error signal (M1~MF)
⑥	Multiplication and division modes number (MD1~ MD4)

# Chapter 5 Trouble Diagnosis and shooting

## 5.1 General

Inverter fault detection and early warning / self-diagnosis function. When the inverter detects a fault code displayed on the digital operator, the fault contact output will start acting to cut off the inverter output, so that the motor is coast to stop (The stop way can be selected for some faults).

When the inverter detects a warning / self-diagnosis, the digital operator will display a warning / self-diagnostic code, but the fault output of the contact does not act. Once the warning is removed, the system will automatically return to its original state.

## 5.2 Fault detection function





When the fault occurs, please refer to Table 5.1 for the possible causes and take appropriate measures.

Use one of the following methods to restart:

1. Set one of multi-function digital input terminals (03-00, 03-07) to 17 (Fault reset), so that the fault reset signal is ON.
2. Press the Reset on digital keypad.
3. Cut off the main circuit power and then open it again.

When a fault occurs, the fault message will be stored in the fault information (group 12 parameters).

**Table 5.1 Fault information and corrective action**

LED display	Description	Possible causes	Corrective action
OC over current	over current : The inverter output current exceeds the OC detection value (about 200% of the rated current)	<ul style="list-style-type: none"> <li>. Acceleration / Deceleration time is too short.</li> <li>. The magnetic switch operation at the inverter output side.</li> <li>. A special motor or applicable capacity is greater than the inverter rated value.</li> <li>. Short circuit or ground fault.</li> </ul>	<ul style="list-style-type: none"> <li>. Prolong acceleration / deceleration time</li> <li>. Check the load wiring</li> <li>. Remove the motor and try to run the inverter</li> </ul>
			
SC short circuit	short circuit : Inverter output or the load is short circuit	<ul style="list-style-type: none"> <li>. Short circuit or ground fault occurs (08-23 = 1).</li> <li>. The faults such as contact and ground short circuit caused by motor damage, insulation deterioration and wire damage.</li> </ul>	<ul style="list-style-type: none"> <li>. Confirm the load wiring</li> </ul>
			
GF ground fault	Ground fault: The current of the ground short circuit at output side exceeds 50% of inverter rated output current and 08-23 = 1 (GF function is enabled).	<ul style="list-style-type: none"> <li>. The defects of motor ground fault or DCCT current sensors.</li> <li>. This is equipment protection, not personal protection.</li> </ul>	<ul style="list-style-type: none"> <li>. Check motor wiring and wiring impedance.</li> </ul>
			
OV over voltage	Over voltage of main circuit: DC voltage exceeds the OV detection value – 410Vdc: 220V class 820Vdc: 440V class (for 440V class, input voltage 01-14 is set to lower than 400V, the OV detection value will be decreased to 700Vdc)	<ul style="list-style-type: none"> <li>. Deceleration time is too short, resulting in recovery energy is too high.</li> <li>. The input voltage is too high.</li> <li>. The use of power factor correction capacitor</li> </ul>	<ul style="list-style-type: none"> <li>. Prolong deceleration time</li> <li>. Check the input circuit and reduce the input voltage to comply the specification requirements.</li> <li>. Remove the power factor correction capacitor.</li> </ul>
			

LED display	Description	Possible causes	Corrective action
UV under voltage	Under voltage of main circuit: DC bus voltage is lower than the UV detection value or the electromagnetic contactor of DC bus is not used, and at the same time, the inverter is operating. About 190Vdc: 220V class; 380Vdc: 440V class (the detection value can be adjusted by 07-13)	<ul style="list-style-type: none"> <li>. The input voltage is too low.</li> <li>. Phase loss of input power</li> <li>. Acceleration time is too short.</li> <li>. The input Voltage is large fluctuation.</li> <li>. Electromagnetic contactor of DC bus is not used or the feedback signal is not unusual.</li> </ul>	<ul style="list-style-type: none"> <li>. Check the input circuit and the power voltage.</li> <li>. Prolong acceleration time.</li> </ul>
UJ			
IPL input phase loss	Input phase loss: Phase loss at the input side of the inverter or there is an imbalance great voltage. When 08-09 = 1 (enabed), this fault will be detected.	<ul style="list-style-type: none"> <li>. IPL occurs.</li> <li>. Terminal screws of R/L1, S/L2 or T/L3 are loose or lost.</li> <li>. Instantaneous power loss occurs.</li> <li>. Input voltage fluctuation is too big.</li> </ul>	<ul style="list-style-type: none"> <li>. Check the input voltage.</li> <li>. Fasten terminal screws.</li> </ul>
IPL			
OPL output phase loss	Output phase loss: Phase loss at the output side of the inverter. When 08-10=1, this fault detection function is enabled.	<ul style="list-style-type: none"> <li>. The output cable or the internal of motor is damaged.</li> <li>. Terminal screws of R/ L1、 S/L2 or T/ L3 are loose or lost.</li> <li>. Motor rated capacity is less than 10% of the inverter rated value.</li> </ul>	<ul style="list-style-type: none"> <li>. Check motor wiring.</li> <li>. Check the motor and the inverter capacity.</li> </ul>
OPL			
OH1 Heat sink is overheating	Heat sink is overheating : The temperature of the heat sink is too high. If heat sink overheating fault has occurred with three times in five minutes, it is required to wait 10 minutes before resetting the fault.	<ul style="list-style-type: none"> <li>. Ambient temperature is too high.</li> <li>. The cooling fan has stopped.</li> <li>. Carrier frequency setting is too high.</li> </ul>	<ul style="list-style-type: none"> <li>. Check the ambient temperature of the inverter.</li> <li>. Check the fan or dust and dirt in the heat sink.</li> <li>. Check the carrier frequency setting.</li> </ul>
OH1			
OL1 Motor overload	Motor overload: Motor overload protection function is enabled according to the overload protection curve 08-05 = xxx1 of the motor internal (motor overload protection enabling).	<ul style="list-style-type: none"> <li>. Voltage setting of V / F mode is too high, resulting in motor over-excitation.</li> <li>. Motor rated current seting(02-01) is incorrect.</li> <li>. Motor load is too big.</li> </ul>	<ul style="list-style-type: none"> <li>. Check the V / F mode.</li> <li>. Check the motor rated current.</li> <li>. Check the load and the operation cycle time.</li> </ul>
OL1			
OL2 Over load of the inverter	over load of the inverter: The overload protection function of the inverter depends on the overload protection curve of inverter internal. When the over load of the inverter is removed, the warning of over load of the inverter will appear. However, if the warning of over load of the inverter has occurred by 4 times in five minutes, it is required to wait 4 minutes to reset the fault.	<ul style="list-style-type: none"> <li>. Voltage setting of V / F mode is too high.</li> <li>. The inverter capacity is too small.</li> <li>. Motor load is too big.</li> </ul>	<ul style="list-style-type: none"> <li>. Check the V / F mode.</li> <li>. Replaced by a higher-capacity inverter</li> <li>. Check the load and the operation cycle time.</li> </ul>
OL2			
OT over torque detection	Over torque detection : Inverter output torque is higher than 08-15 (over torque detection level) and exceeds set time of 08-16, then the inverter enables the base block (08-14 = 0).	Mechanical load is too big.	<ul style="list-style-type: none"> <li>. Check the application or operating status</li> <li>. Check whether 08-15 and 08-16 are appropriate values</li> </ul>
OT			
UT under torque detection	Under torque detection: When inverter output torque is lower than 08-19 (under torque detection level) and exceeds set time of 08-20,	Reduce the mechanical load suddenly. (for example, the belt is broken)	<ul style="list-style-type: none"> <li>. Check the application or operating status</li> <li>. Check whether 08-19 and 08-20 are appropriate values</li> </ul>
UT			

LED display	Description	Possible causes	Corrective action
	then the inverter enables the base block (08-18 = 0).		
CLB Current Protection Level B	Warning of inverter over current: Inverter current reaches the current protection level B	Inverter current is too big. Motor load is too big.	Check the load and the operation cycle time.
CLB			
OS over speed	Motor over speed : . Motor speed is over than 20-20 (PG Over speed Level) and exceeds set time of 20-21 (PG over speed time). . Subject to 20-19 (= 0 or 1), the inverter will be stopped. . This fault detection is valid only in in V / F + PG and SV control mode (00-00 = 1 or 3 or 4). . Motor speed can be monitored by 12-22	. Speed reference is too high. . Excessive occurrence reflects insufficiency in the speed or the degree,	. Check the speed reference gain and the settings of 20-20, 20-21 are appreciate or not. . Adjust the parameters of the set ASR in group 21.
OS			
PGO PG open circuit	PG open circuit detection: . When the inverter is operating, the PG pulse is not detected within the PG open circuit detection time(20-26). . Subject to 20-25(= 0 or 1), the inverter will be stopped. . This fault detection is valid only in V / F + PG and SV control mode (00-00 = 1 or 3 or 4).	. PG connection is incorrect. . PG has no power. . PG wire is broken. . Braking mechanism is enabled.	. Check PG wiring. . Check PG power . Check PG wiring . Check the motor action mechanism
PGO			
DEV speed deviation	speed deviation : . Motor speed deviation is over than the setting of 20-23 (PG speed deviation level) and exceeds 20-24 (PG deviation time). . Subject to 20-22(=0 or 1), the inverter will be stopped. . This fault detection function is valid only in V / F +PG and SV control mode (00-00 = 1 or 3 or 4) .	. The load is too big. . The load has been locked. (for example, the braking mechanism is enabled.) . PG wiring error. . PG the parameter setting (group 20) is incorrect. Acceleration/deceleration time is too short.	. Check mechanical load . . Check the braking mechanism is enabled or not, or reduce the load. . Check PG connection. . Verify the the parameter settings of 20-23 and 20-24 are correct or not. . Prolong acceleration/deceleration time.
DEV			
CE communication error	Modbus communication error : No communication is received in time of 09-06 (communication error detection time) . Subject to 09-07(= 0 to 2), this fault protection is enabled..	. Connection is broken off or the host has stopped communication.	Check all connections and verify all software architecture at the client side.
CE			
FB PID feedback loss	PID feedback loss: In PID feedback loss detection (10-11 = 2, Motor is coast to stop), PID feedback inputs <PID feedback loss detection level (10-12) and the PID feedback loss detection time is exceeded (10-13) .	PID feedback sensor can not act properly or it is not install correctly.	. Check PID feedback method setting is correct or not. . Ensure the correct installation and the proper operation of PID feedback signal.
FB			
STO Safety switch	Safety switch of the inverter	F1 and F2 on the inverter control circuit board are open circuit.	. Check F1 and F2 on the inverter control circuit board are open circuit or not.
STO			

LED display	Description	Possible causes	Corrective action				
EF1 External fault (S1)	External fault ( Terminal S1)	External fault input is received by multifunction digital input terminals. Subject to 03-00 to 03-07(= 25), Inverter external fault selection 08-24= 0 or 1, Significant fault.	<ul style="list-style-type: none"> <li>. Check the faults of external causes.</li> <li>. Reset the external fault of multi function digital input.</li> </ul>				
EF1							
EF2 External fault (S2)	External fault ( Terminal S2)						
EF2							
EF3 External fault (S3)	External fault ( Terminal S3)						
EF3							
EF4 External fault (S4)	External fault ( Terminal S4)						
EF4							
EF5 External fault (S5)	External fault ( Terminal S5)						
EF5							
EF6 External fault (S6)	External fault ( Terminal S6)						
EF6							
EF7 External fault (S7)	External fault ( Terminal S7)						
EF7							
EF8 External fault (S8)	External fault ( Terminal S8)						
EF8							
CF07 Motor control fault	Motor control fault			In SLV mode, running fault.	<ul style="list-style-type: none"> <li>. Perform rotational auto-tuning</li> <li>. If rotational auto-tuning can't be performed, please perform the static auto-tuning, or increase the set value of 01-08.</li> </ul>		
CF07							
FU fuse open	DC fuse : open circuit DC fuse (Models 230V 50HP or above, 460V 75HP or above) open circuit .			<ul style="list-style-type: none"> <li>.The power transistor is damaged due to the short circuit at the inverter output side.</li> <li>.Check there are short circuit or not between the terminal ⊖ and U/T1, V/T2, W/T3.</li> </ul>	<ul style="list-style-type: none"> <li>.Check there is short circuit or not between the motor and the wire or the insulation is damaged.</li> <li>. Repair / replace the inverter.</li> </ul>		
FU							

## 5.3 Warning / self-diagnosis detection function







When the inverter detects a warning, the digital operator will display the warning code (flash), and the fault output contact will not act. Once the warning is removed, the system will automatically restore the original state.









When the inverter detects a self-diagnosis function (for example, there is an invalid setting or two parameters are contradictory), the digital operator will display the self-diagnosis code, and the fault output contact will not act. Before the parameter has been correctly set, the inverter can not execute the operation command.

When a warning or a self-diagnostic error occurs, refer to Table 5.2 to confirm and correct the error.







When the RESET key is pressed at this time, the warning message (flash) disappears. If the warning or self-diagnostic error still exists, the warnings will be displayed again in 5 seconds.









**Table 5.2 warning / self-diagnosis and corrective actions**









LED display	Description	Possible causes	Corrective action
OV ( flash ) over voltage	Voltage of main circuit: The DC bus voltage exceeds the OV detection level, and the inverter has stopped. 410Vdc: 230 V class 820Vdc: 460 V class	The input power voltage is too high.	Check the input power voltage
			
UV ( flash ) under voltage	Voltage of main circuit: The DC bus voltage is lower than the UV detection level, and the inverter has stopped. 190Vdc: 230V class 380Vdc: 460V class (07-13 can set the detection level)	. The input power voltage is too low. . Momentary power loss occurs.	. Check the input power voltage. . Check the input circuit. . Check the main circuit MC.
			
OH2 ( flash ) Inverter over heating warning	Inverter over heating warning: Use multi function digital input terminals to input the inverter over heating warning. (03-00 ~03-07=31)	Multi function digital input terminal receives the occurrence signal of external over heating warning.	Check the external condition
			
OT ( flash ) over torque detection	over torque detection : The inverter output current is higher than 08-15 (OT detection level ) and exceeds set time of 08-16. Subject to 08-14=1, the inverter continues operation.	Mechanical load is too big.	.Check the application or the machine's operation status. .Check the set values of 08-15 and 08-16.
			
UT ( flash ) under torque detection	Under torque detection : The inverter output current is lower than 08-19 (under torque detection level ) and exceeds set time of 08-20. Subject to 08-18=1, the inverter continues operation.	Mechanical load is removed momentarily. ( for example, the belt is broken off )	.Check the application or the machine's operation status. .Check the settings of 08-19 and 08-20.
			
bb1 ( flash ) External block	External block ( Terminal S1)	External block input is received by multifunction digital input terminals.	.Remove the causes of external block.
			
bb2 ( flash ) External block	External block ( Terminal S2)		
			
bb3 ( flash )	External block ( Terminal S3)		



LED display	Description	Possible causes	Corrective action
External block			
			
bb4 ( flash ) External block	External block ( Terminal S4)		
			
bb5 ( flash ) External block	External block ( Terminal S5)		
			
bb6 ( flash ) External block	External block ( Terminal S6)		
			
bb7 ( flash ) External block	External block ( Terminal S7)		
			
bb8 ( flash ) External block	External block ( Terminal S8)		
			
OS ( flash ) Motor over speed	Motor over speed : . Motor speed deviation is higher than 20-20 (PG over speed level) and exceeds set time of 20-21 (PG over speed time). . This fault is valid only in V / F +PG and SV control mode (00-00 = 1 or 3 or 4) .	.Speed reference is too high. .Speed response overshoot or deficient response occurs.	.Check the speed reference gain and check 20-20, 20-21 settings. .Adjust ASR setting (group 20 parameter).
			
PGO ( flash ) PG open circuit	PG open circuit detection: .When the inverter is operating, PG pulse is not detected within the PG open circuit time (20-26). .Subject to 20-25(= 0 or 1), the inverter will be stopped. . This fault is valid only in V / F +PG and SV control mode (00-00 = 1 or 3 or 4) .	.PG wiring error . .PG power is removed. .PG is broken off. .Braking mechanism is enabled.	.Check the PG wiring. .Check the PG input power.
			
DEV ( flash ) speed deviation	Motor speed deviation: .Motor speed deviation is higher than 20-23 (PG speed deviation level) and exceeds set time of 20-24 (PG deviation time). .Subject to 20-22(=0 or 1), the inverter will be stopped. . This fault detection function is valid only in V / F +PG and SV control mode (00-00 = 1 or 3 or 4) .	. The load is too big. . The load has been locked. (For example, the braking mechanism is enabled.). . PG wiring error. . PG the parameter setting (group 20) is incorrect. . Acceleration/deceleration time is too short.	. Check mechanical load. . Check the braking mechanism is enabled or not, or reduce the load. .Check PG connection. .Verify the the parameter settings of 20-23 , 20-24 and 20-28are correct or not. . Prolong acceleration/deceleration
			

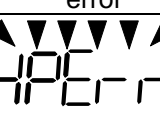

LED display	Description	Possible causes	Corrective action
			time.
OL1 Motor over load 	Motor over load: Motor over load protection function is enabled according to the over load curve of motor internal 08-05 =xxx1 (Motor over protection is enabled.).	<ul style="list-style-type: none"> <li>.The voltage setting of V/F mode is too high, resulting in motor over excitation.</li> <li>. Motor rated current setting (02-01) is incorrect.</li> <li>. Motor load is too big.</li> </ul>	<ul style="list-style-type: none"> <li>.Check V/F mode .</li> <li>.Check Motor rated current .</li> <li>.Check the load and operation cycle.</li> <li>.Check V/Fmode .</li> </ul>
OL2 over load of the inverter 	over load of the inverter: Over load fault of the inverter has occurred , but time is less than 4 minutes (if time is over 4 minutes, this warning will be cleared automatically.)	<ul style="list-style-type: none"> <li>. The voltage setting of V/F mode is too high, and the inverter capacity is too small.</li> <li>.Motor load is too big.</li> </ul>	<ul style="list-style-type: none"> <li>. Replaced by higher capacity inverter</li> <li>.Check the load and the operation cycle</li> </ul>
CE ( flash ) communication error 	Modbus communication error : .when 09-07= 3, no communication data is received over 2 seconds.	<ul style="list-style-type: none"> <li>. Connection is broken off.</li> <li>. The host has stopped the data transmission.</li> </ul>	Check all connections and verify all software architecture at the client side.
CLA over current protection level A 	Warning of inverter over current: Inverter current reaches current protection level A	<ul style="list-style-type: none"> <li>Inverter current is too big.</li> <li>.Motor load is too big.</li> </ul>	Check the load and operation cycle.
CLB over current protection level B 	Warning of inverter over current: inverter current reaches current protection level B	<ul style="list-style-type: none"> <li>Inverter current is too big.</li> <li>.Motor load is too big.</li> </ul>	Check the load and operation cycle.
ADL current feedback protection level 	Warning of inverter over current: inverter current reaches current feedback protection level	<ul style="list-style-type: none"> <li>Inverter current is too big.</li> <li>.Motor load is too big.</li> </ul>	Check the load and operation cycle.

LED display	Description	Possible causes	Corrective action
EF1 ( flash ) External fault (S1)	External fault ( Terminal S1)	.External fault input is received by multifunction digital input terminals. .Subject to 08-24=2, the inverter continues operation.	.Remove external fault causes. .Reset the external fault of multifunction digital input
			
EF2 ( flash ) External fault (S2)	External fault ( Terminal S2)		
			
EF3 ( flash ) External fault (S3)	External fault ( Terminal S3)		
			
EF4 ( flash ) External fault (S4)	External fault ( Terminal S4)		
			
EF5 ( flash ) External fault (S5)	External fault ( Terminal S5)		
			
EF6 ( flash ) External fault (S6)	External fault ( Terminal S6)		
			
EF7 ( flash ) External fault (S7)	External fault ( Terminal S7)		
			
EF8 ( flash ) External fault (S8)	External fault ( Terminal S8)		
			
EF9 ( flash ) error of forward/rever sal rotation	.Forward and reversal rotation command ( 2 –wire type operation ) are input at the same time within 0.5 second or above. .Subject to 07-09 to set the motor stop method. . After the fault is removed, the inverter returns normal status.	Forward and reversal rotation command are input at the same time. ( refer to 2–wire type operation )	Check external procedure logic
			
SE01 Rang setting error	The parameter setting exceeds the range: When the parameter setting	.The parameter setting exceeds the allowed range . In some situation, the	Check the parameter setting.

LED display	Description	Possible causes	Corrective action
	exceeds the allowed range.	parameter setting will be based on the other parameter setting( for example 02-00>02-01, 02-20>02-21 or 00-12>00-13 and so on).	
SE02 Digital input terminal error	Errors of multifunction digital input terminal	Errors of multifunction digital input terminals (03-00 to 03-07), as described in the following:  ① UP/DOWN commands are not set at the same time( they must be used together). ② UP/DOWN commands (08 and 09) and ACC/DEC commands (11) are set at the same time. ③ Speed search 1 (19, maximum frequency) and Speed search 2 (34, from the set frequency) are set at the same time.	Check the parameter setting
			
SE03 V/f curve error	V/f curve setting error:	V/F curve setting is not based on the following architecture: ① 01-02 > 01-12 >01-06 > (Fmax) (Fbase) (Fmid1) 01-08; (Fmin) ②01-16 > 01-24 > 01-20 > 01-22; (Fmax(2)) (Fbase(2)) (Fmid(1)) (Fmin(2))	Confirm V/F parameter setting.
			
SE05 PID selection error	PID selection error:	10-00 and 10-01 are all set to 1(AI1) or 2 (AI2) at the same time.	Check the set values of parameters 10-00, 10-01
			
HPErr Model selection error	Inverter capacity setting error: Inverter capacity setting 13-00 does not match the rated voltage.	The inverter capacity setting (13-00) does not match the voltage class of the hardware.	Check the inverter capacity setting (13-00) matches the voltage class of the hardware or not.
			
SE07 PG card error	Inverter PG card setting error	This inverter PG card has not been installed.	Check the inverter PG device. Check the control mode
			
SE08 PM Motor mode error	A510 inverter of this horse power does not support the PM Motor mode	Inverter does not support PM Motor mode	Check the control mode
			
SE09 PI setting error	Inverter PI setting error	Inverter PI option (03-30) selection conflicts with PID source (10-00 and 10-01).	Check inverter PI option (03-30) selection and PID source (10-00 and 10-01)
			

LED display	Description	Possible causes	Corrective action
FB ( flash ) PID feedback breaking	PID feedback breaking: PID feedback breaking detection is enabled (when 10-11=1), keep on operation, and PID feedback inputs the PID feedback breaking detection time (10-13)of PID feedback breaking level.	PID feedback signal (such as the transformer) does not act or is incorrectly installed.	.Check the set PID feedback method is correct or not. .Ensure correct installation and the proper operation of PID feedback signals.
	Unattended Start Protection ( USP )is enabled (enabled in booting)	<ul style="list-style-type: none"> <li>. USP in booting (set by              multi-function digital input) is              enabled, the inverter will not              accept any operation              command.</li> <li>. Before the warning              information is removed, the              inverter can't enter the              operating mode. (Please              refer to related instructions in              the full manual 03-00 - 03-08              = 50)..</li> </ul>	<ul style="list-style-type: none"> <li>.Operation command is              turned off, or terminal reset              operation is performed              (03-00 to 03-07 are 3), or              use the RESET key on the              digital operator to reset..</li> <li>.Close the USP signal and              restart the power.</li> </ul>
USP ( flash ) Unattended Start Protection			

## 5.4 Auto-tuning error

When the auto-tuning fault occurs, the fault of "AtErr" will be displayed on the digital operator and the motor stops. The fault information is displayed on the 17-11. The fault digital output contact does not act. Refer to Table 5.3, to identify and correct the faults.

**Table 5.3 Auto-tuning fault and corrective actions**

Error	Description	Cause	Corrective action
01	Motor data input error	<ul style="list-style-type: none"> <li>· Input data error of auto-tuning</li> <li>· Error relationship between the motor output current and motor rated current</li> </ul>	<ul style="list-style-type: none"> <li>· Check the input data for auto-tuning (17-00 to 17-09).</li> <li>· Check the inverter capacity</li> </ul>
02	Tuning error of the resistor R1 of motor wire to wire.	<ul style="list-style-type: none"> <li>· Auto-tuning is not completed within a certain time</li> <li>· Auto-tuning result is beyond the parameter setting.</li> <li>· Exceed the motor rated current.</li> <li>· Three phase output of the inverter is broken off.</li> </ul>	<ul style="list-style-type: none"> <li>· Check the input data of auto-tuning (17-00 to 17-09)</li> <li>· Check motor connection.</li> <li>· Disconnect all loads connected to the motor.</li> <li>· Check the inverter current detection circuit, including the current sensor.</li> <li>· Check motor connection.</li> <li>· Check motor installation.</li> </ul>
03	Tuning error of motor leakage inductance		
04	Tuning error of motor rotor resistance R2.		
05	Tuning error of motor mutual inductance Lm		
07	Deadtime compensation detection error		
06	Motor encoder error	Motor encoder noise is too large	Confirm the motor rated current (02-01, 02-21).
08	Motor acceleration error (only suitable for the rotary type auto-tuning).	Motor fails to accelerate in specified time (00-14=20sec).	<ul style="list-style-type: none"> <li>· Increase the acceleration time (00-14) .</li> <li>· Disconnect all loads connected to the motor.</li> </ul>
09	Other errors of auto-tuning	Other errors of auto-tuning (except the ATE-01~ATE-08 error, such as the no load current is higher than 70%, rated current or torque exceeds 100% of the reference).	<ul style="list-style-type: none"> <li>· Check motor connection.</li> <li>· Check the input data of auto-tuning</li> </ul>

## 5.5 PM motor auto-tuning error

When the PM motor auto-tuning fault occurs, the fault information of “IPErr” (PM motor tuning failure) will be displayed on the digital operator and the motor stops. The fault information is displayed on 22-18. The fault digital output contact does not act. Refer to Table 5.4, to identify and correct the faults.

**Table 5.4 Auto-tuning fault and corrective actions for PM motor**

Error	Description	Cause	Corrective action
01	Static magnetic pole alignment failure	·Error relationship between motor output current and motor rated current.	·Check input data of auto-tuning (22-02). ·Check the inverter capacity ·Check Motor connection
02	Without PG option card	· magnetic pole can not be aligned without PG option card	·Check PM's PG card has been installed properly or not.
03	Rotary magnetic pole alignment is forced to stop.	·system abnormality	·Check it enters other protection programs or not.
04	Rotary magnetic pole alignment is time out	·Motor can not operate properly.	·Check Motor connection
05	Circuit tuning is time out	·System abnormality occurs in circuit tuning process.	· Check it enters other protection programs or not.
06	Encoder error	·Motor encoder noise is too large.	·Check PG card has been grounded or not.
07	Other motor tuning error	·Other errors of auto-tuning	·Check motor connection. ·Check input data of auto-tuning
08	Current abnormality occurs in rotary magnetic pole alignment.	·Motor can not operate at low speed.	·it is possible that the connections of PG card A, B are reversal. It can be redone. The system will automatically adjust the wiring definition. ·Check motor connection
09	Current abnormality in circuit tuning.	· Error relationship between motor output current and motor rated current.	·Check input data of auto-tuning (22-02). ·Check the inverter capacity
10	Retry magnetic pole alignment and circuit tuning.	Auto-tuning is not completion.	Retry magnetic pole alignment and circuit tuning.

# Chapter 6 Peripheral devices and option

## 6.1 List of braking resistor and braking detection module

A510 220V 1 ~ 25HP/440V 1 ~ 30HP models have built in braking resistor. When the braking capacity is insufficient, an external braking resistor can be connected between B1 / P and B2 directly; for models above 220V 30HP/440V 40HP, an external braking detection module (connected to two ends  $\oplus$  -  $\ominus$  of the inverter) and a braking resistor (connected to two ends of the detection module B-P0) will be required at the same time.

Table 6.1 List of braking resistor and braking detection module

Inverter			Braking detection module		Braking resistor				Rough of braking torque
V	HP	Rated Current (A) HD/ND	Model	Parallel Number	Part Number	Resistor specification	Used Number	Resistor size (L*W*H)mm	
220V 1 $\phi$ /3 $\phi$	1	5/6	-	-	JNBR-150W200	150W/200 $\Omega$	1	251*27*60	119%, 10%ED
	2	8/9.6	-	-	JNBR-150W100	150W/100 $\Omega$	1	251*27*60	119%, 10%ED
	3	11/12	-	-	JNBR-260W70	260W/70 $\Omega$	1	274*34*78	115%, 10%ED
220V 3 $\phi$	5	17.5/21	-	-	JNBR-390W40	390W/40 $\Omega$	1	395*34*78	119%, 10%ED
	7.5	25/30	-	-	JNBR-520W30	520W/30 $\Omega$	1	400*40*100	108%, 10%ED
	10	33/40	-	-	JNBR-780W20	780W/20 $\Omega$	1	400*40*100	119%, 10%ED
	15	47/56	-	-	JNBR-2R4KW13R6	2400W/13.6 $\Omega$	1	535*50*110 (*2 pcs)	117%, 10%ED
	20	60/69	-	-	JNBR-3KW10	3000W/10 $\Omega$	1	615*50*110 (*2 pcs)	119%, 10%ED
	25	73/79	-	-	JNBR-4R8KW8	4800W/8 $\Omega$	1	535*50*110 (*4 pcs)	119%, 10%ED
	30	85/110	JNTBU-230	1	JNBR-4R8KW6R8	4800W/6.8 $\Omega$	1	535*50*110 (*4 pcs)	117%, 10%ED
	40	115/138	JNTBU-230	2	JNBR-3KW10	3000W/10 $\Omega$	2	615*50*110 (*4 pcs)	119%, 10%ED
	50	145/169	JNTBU-230	2	JNBR-3KW10	3000W/10 $\Omega$	2	615*50*110 (*4 pcs)	99%, 10%ED
	60	180/200	JNTBU-230	2	JNBR-4R8KW6R8	4800W/6.8 $\Omega$	2	535*50*110 (*8 pcs)	117%, 10%ED
	75	215/250	JNTBU-230	2	JNBR-4R8KW6R8	4800W/6.8 $\Omega$	2	535*50*110 (*12 pcs)	98%, 10%ED
	100	283/312	JNTBU-230	3	JNBR-4R8KW6R8	4800W/6.8 $\Omega$	3	535*50*110 (*12 pcs)	108%, 10%ED
	125	346/360							
	150	415/450							
440V 3 $\phi$	1	3.4/4.1	-	-	JNBR-150W750	150W/750 $\Omega$	1	251*27*60	126%, 10%ED
	2	4.2/5.4	-	-	JNBR-150W400	150W/400 $\Omega$	1	251*27*60	119%, 10%ED
	3	5.5/6.9	-	-	JNBR-260W250	260W/250 $\Omega$	1	274*34*78	126%, 10%ED
	5	9.2/11.1	-	-	JNBR-400W150	400W/150 $\Omega$	1	395*34*78	126%, 10%ED
	7.5	14.8/17.5	-	-	JNBR-600W130	600W/130 $\Omega$	1	470*40*100	102%, 10%ED
	10	18/23	-	-	JNBR-800W100	800W/100 $\Omega$	1	535*50*110	99%, 10%ED
	15	24/31	-	-	JNBR-1R6KW50	1600W/50 $\Omega$	1	615*50*110	126%, 10%ED

Inverter			Braking detection module		Braking resistor				Rough of braking torque
V	HP	Rated Current (A) HD/ND	Model	Parallel Number	Part Number	Resistor specification	Used Number	Resistor size (L*W*H)mm	
	20	31/38	-	-	JNBR-1R5KW40	1500W/40Ω	1	615*50*110	119%, 10%ED
	25	39/44	-	-	JNBR-4R8KW32	4800W/32Ω	1	535*50*110 (*4 pcs)	119%, 10%ED
	30	45/58	-	-	JNBR-4R8KW27R2	4800W/27.2Ω	1	535*50*110 (*4 pcs)	117%, 10%ED
	40	60/72	JNTBU-430	1	JNBR-6KW20	6000W/20Ω	1	615*50*110 (*4 pcs)	119%, 10%ED
	50	75/88	JNTBU-430	2	JNBR-4R8KW32	4800W/32Ω	2	535*50*110 (*8 pcs)	119%, 10%ED
	60	91/103	JNTBU-430	2	JNBR-4R8KW27R2	4800W/27.2Ω	2	535*50*110 (*8 pcs)	117%, 10%ED
	75	118/145	JNTBU-430	2	JNBR-6KW20	6000W/20Ω	2	615*50*110 (*8 pcs)	126%, 10%ED
	100	150/165	JNTBU-430	3	JNBR-6KW20	6000W/20Ω	3	615*50*110 (*12 pcs)	139%, 10%ED
	125	180/208	JNTBU-430	3	JNBR-6KW20	6000W/20Ω	3	615*50*110 (*12 pcs)	115%, 10%ED
	150	216/250	JNTBU-430	3	JNBR-6KW20	6000W/20Ω	3	615*50*110 (*12 pcs)	99%, 10%ED
	175	260/296	JNTBU-430	5	JNBR-6KW20	6000W/20Ω	5	615*50*110 (*20 pcs)	134%, 10%ED
	215	295/328	JNTBU-430	6	JNBR-6KW20	6000W/20Ω	6	615*50*110 (*24 pcs)	131%, 10%ED
	250	370/414							
	300	450/515							
	375	523/600							

※ Note 1: Options: 440V 50HP: (JUVPHV-0060+JNBR-9R6KW16) x 1

440V 60HP: (JUVPHV-0060+JNBR-9R6KW13R6) x 1

※ Note 2: JUVPHV-0060 without UL certificate

※ Note 3: In the installation of braking module and braking resistor, you needs to keep an appropriate distance from the inverter, and maintain a good ventilation of the installation environment.



## 6.2 AC reactor

- When the capacity of power system is much larger than the inverter capacity or the inverter is very close to the power system wiring (in 10 meters), or the factor of the power supply needs to be increased, an external AC reactor may be added in.
- Please select an AC reactor according to the following table.



Table 6.2 List of

Model			AC reactor	
V	HP	Rated Current(A) HD/ND	Part Number	Specification(mH/A)
220V 1 $\phi$ /3 $\phi$	1	5/6	3M200D1610021	2.1mH/5A
	2	8/9.6	3M200D1610030	1.1mH/10A
	3	11/12	3M200D1610048	0.71mH/15A
220V 3 $\phi$	5.4	17.5/21	3M200D1610056	0.53mH/20A
	7.5	25/30	3M200D1610064	0.35mH/30A
	10	33/40	3M200D1610072	0.265mH/40A
	15	47/56	3M200D1610081	0.18mH/60A
	20	60/69	3M200D1610099	0.13mH/80A
	25	73/79	3M200D1610102	0.12mH/90A
	30	85/110	3M200D1610111	0.09mH/120A
	40	115/138	3M200D1610269	0.07mH/160A
	50	145/169	3M200D1610277	0.05mH/200A
	60	180/200	3M200D1610285	0.044mH/240A
	75	215/250	3M200D1610293	0.038mH/280A
	100	283/312	3M200D1610307	0.026mH/360A
440V 3 $\phi$	1	3.4/4.1	3M200D1610137	8.4mH/3A
	2	4.2/5.4	3M200D1610145	4.2mH/5A
	3	5.5/6.9	3M200D1610153	3.6mH/7.5A
	5.4	9.2/11.1	3M200D1610161	2.2mH/10A
	7.5	14.8/17.5	3M200D1610170	1.42mH/15A
	10	18/23	3M200D1610188	1.06mH/20A
	15	24/31	3M200D1610196	0.7mH/30A
	20	31/38	3M200D1610200	0.53mH/40A
	25	39/44	3M200D1610218	0.42mH/50A
	30	45/58	3M200D1610226	0.36mH/60A
	40	60/72	3M200D1610234	0.26mH/80A
	50	75/88	3M200D1610242	0.24mH/90A
	60	91/103	3M200D1610251	0.18mH/120A
	75	118/145	3M200D1610315	0.15mH/150A
	100	150/165	3M200D1610323	0.11mH/200A
	125	180/208	3M200D1610331	0.09mH/250A
	150	216/250	3M200D1610340	0.06mH/330A
	175	260/296	3M200D1610340	0.06mH/330A
	215	295/328	4M200D0010008	0.05mH/400A
	250	370/414		
300	450/515			
375	523/600			



(Note) AC reactors listed in this table are only applicable to the converter input side. Please don't connect to the output side.

Both 220V class 50HP ~ 100HP and 440V class 75HP ~ 215HP have built in DC reactors. If it is necessary in application, AC reactor can be added in.

## 6.3 Harmonic Filter

Filter selection table	Rated load power	Rated load power	Filter efficiency	Input/Output connections		Capacitance disconnections	Weight	NEMA 1 covers**
Filter	@400VAC/50Hz [kW]	@500VAC/50Hz [kW]	@25°C/50Hz [%]				[Kg]	Order code
FN 341x-10-44	4	5.5	98.5	-44		-44	13	1151-081
FN 341x-13-44	5.5	7.5	98.5	-44		-44	14	1151-081
FN 341x-16-44	7.5	11	98.5	-44		-44	21	1151-082
FN 341x-24-33	11	15	98.5	-33		-44	27	1151-083
FN 341x-32-33	15	18.5	98.5	-33		-44	31	1151-083
FN 341x-38-33	18.5	22	98.6	-33		-44	35	1151-083
FN 341x-45-34	22	30	98.7	-34		-33	45	1151-084
FN 341x-60-34	30	37	98.8	-34		-33	54	1151-084
FN 341x-75-35	37	45	98.9	-35		-34	65	1151-085
FN 341x-90-35	45	55	99	-35		-34	77	1151-085
FN 341x-110-35	55	75	99.1	-35		-34	86	1151-085

FN 341x-150-40	75	90	99.2	-40		-35	118	1151-086
FN 341x-180-40	90	110	99.3	-40		-35	136	1151-086
FN 341x-210-40	110	132	99.3	-40		-35	154	1151-086
FN 341x-260-99	132	160	99.4		-99	-35	201	1151-086
FN 341x-320-99	160	200	99.5		-99	-35	201	1151-086

Filter selection table	Rated load power	Filter efficiency	Input/Output connections		Capacitance disconnections	Weight	NEMA 1 covers**
Filter	@460VAC/60Hz [kW]	@25°C/50Hz [%]				[Kg]	Order code
FN 341x-8-44	5	98.5	-44		-44	12	1151-081
FN 341x-11-44	7.5	98.5	-44		-44	13	1151-081
FN 341x-15-44	10	98.5	-44		-44	17	1151-082
FN 341x-21-33	15	98.5	-44		-44	21	1151-082
FN 341x-28-33	20	98.6	-33		-44	28	1151-083
FN 341x-35-33	25	98.6	-33		-44	32	1151-083
FN 341x-41-34	30	98.7	-33		-44	35	1151-083
FN 341x-53-34	40	98.9	-34		-33	48	1151-084
FN 341x-65-35	50	99	-34		-33	52	1151-084
FN 341x-80-35	60	99.1	-35		-34	69	1151-085
FN 341x-105-35	75	99.2	-35		-34	77	1151-085
FN 341x-130-35	100	99.3	-35		-34	87	1151-085
FN 341x-160-40	125	99.4	-40		-35	124	1151-086
FN 341x-190-40	150	99.4	-40		-35	132	1151-086
FN 341x-240-99	200	99.5		-99	-35	185	1151-086
FN 341x-310-99	250	99.5		-99	-35	202	1151-086

FN 3410/FN 3411-...	10	13	16		24	32	38	45	60	75	90	110	150	180	210	260	320
FN 3412/FN 3413-...	8	11	15	21	28	35	41	53	65	80	105	130	160	190		240	310
A	400	700	430	430	520	520	520	590	590	750	750	750	1000	1000	1000	1000	1000
B	170	170	210	210	250	250	250	300	300	320	320	320	500	500	500	500	500
C	190	190	210	210	280	280	280	300	300	300	300	300	450	450	450	450	450
E	380	380	410	410	495	495	495	565	565	725	725	725	240	240	240	240	240
F	130	130	170	170	200	200	200	250	250	270	270	270	338	338	338	338	338
G	7	7	9	9	11	11	11	11	11	11	11	11	14X30	14X30	14X30	14X30	14X30
J	M6	M6	M6	M6	M8	M8	M8	M8	M8	M10	M10	M10	M10	M10	M10	M10	M10
V																25	25
W																6	6
X																12.5	12.5
Y																40	40
Z																11	11

ALL dimensions in mm

**Mechanical data**

FN 3410/FN 3411-10 to -110

FN 3412/FN 3413-8 to -130

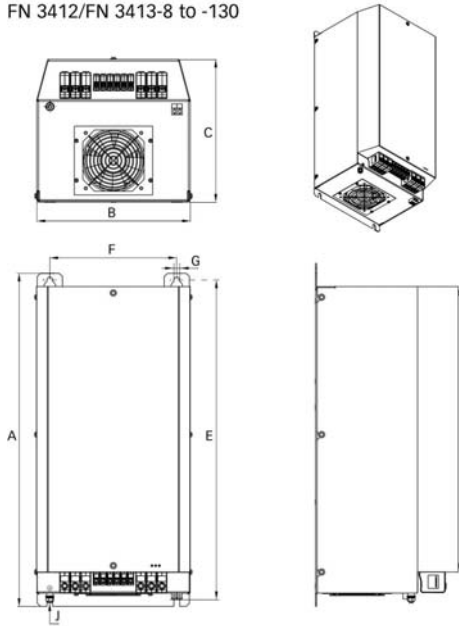

FN 3410/FN 3411-150 to -210

FN 3412/FN 3413-160 and -190

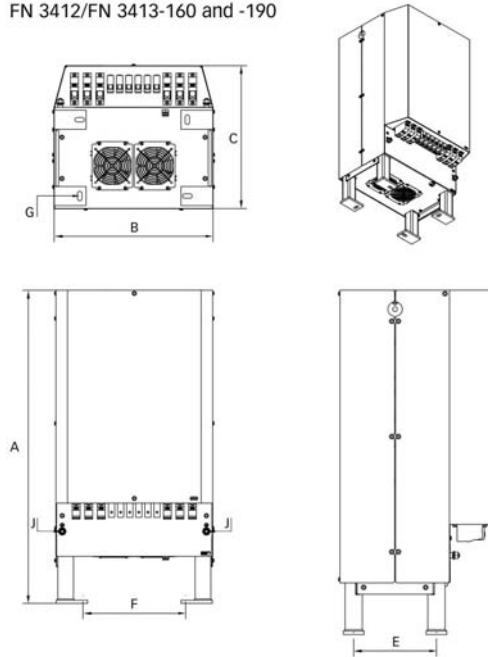

FN 3410/FN 3411-260 and -320

FN 3412/FN 3413-240 and -310

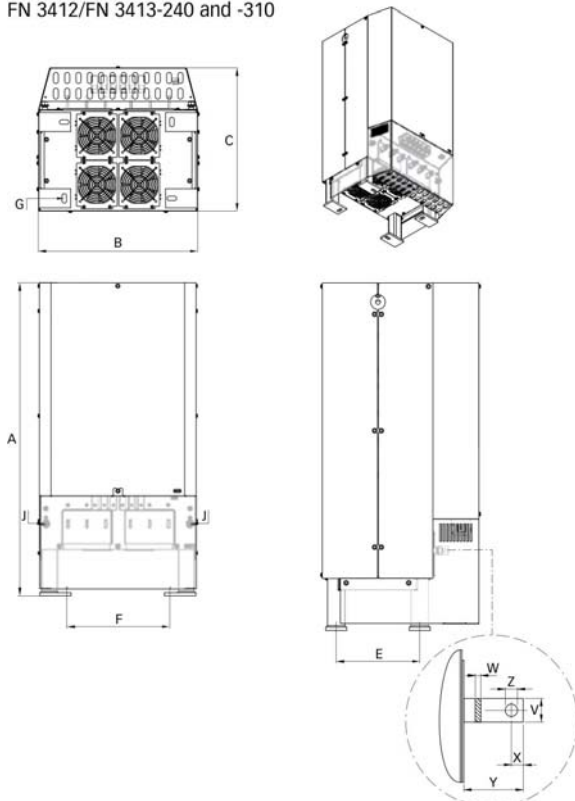

**Installation.** All filters from FN 341x-8 to -150 are wall mountable and have to be operated vertically. The filters FN 341x-150 and higher are designed for floor mounting. In order to allow for sufficient air flow all filters must be clear on top and bottom min. 150mm.

**Optional NEMA1 cover.** All filters can be optionally fitted with a NEMA1 cover. Please find order codes on previous pages.



Filter connector cross sections	-33	-34	-34	-40	-44
Solid wire	16m m <sup>2</sup>	35m m <sup>2</sup>	50m m <sup>2</sup>	95m m <sup>2</sup>	10m m <sup>2</sup>
Flex wire	10m m <sup>2</sup>	25m m <sup>2</sup>	50m m <sup>2</sup>	95m m <sup>2</sup>	6m m <sup>2</sup>
AWG type wire	AWG 6	AWG 2	AWG 1/0	AWG 4/0	AWG 8
Recommended torque	1.5-1.8Nm	4.0-4.5Nm	7.0-8.0Nm	17-20Nm	1.0-1.2Nm

## 6.4 Noise filter

### A. Noise filter is used at the input side

- . If you need to comply with EN 61800-3, A510 220V model requires being supported by a special filter in application and built-in filter models can be selected for 440V.

Table 6.3 Noise filter for the input side

Inverter model		Noise filter			
Supply voltage	HP	Model	Rated current	Dimension	Part Number
1 $\phi$ 220V	1HP/2HP	FS32121-18-99	18	300*100*55	4KA53X077T01
	3HP	FS32120-21-99	23	300*100*55	4KA53X078T01
3 $\phi$ 220V	1HP/2HP	FS32125-10-99	11	250*45*70	4KA53X079T01
	3HP/5HP	FS32124-21-99	23	270*50*85	4KA53X080T01
	7.5HP/10HP	FS32123-40-99	42	250*85*90	4KA53X081T01
	15HP	FS32125-56-99	61	250*85*90	4KA53X082T01
	20HP/25HP	FS32125-79-99	86	290*95*90	4KA53X083T01
	30HP/40HP	FS32125-138-99	150	380*237.5*93	4KA53X084T01
	50HP/60HP	FS32125-211-99	232	380*237.5*93	-
	75HP/100HP	FS32125-312-99	343	380*237.5*93	-
3 $\phi$ 440V	1HP/2HP/3HP	FS32128-6-99	8	63.5*130*92	4KA53X085T01
	5HP/7.5HP	FS32127-18-99	19	85.5*140*91.2	4KA53X086T01
	10HP/15HP	FS32126-31-99	33	100.7*210*101	4KA53X087T01
	20HP/25HP/30HP	FS32126-58-99	63	117.7*265*129.3	4KA53X088T01
	40HP/50HP/60HP	FS32126-103-99	112	351.5*284*127.4	4KA53X089T01
	75HP/100HP	FS32126-165-99	181	380*237.5*93	-
	125HP/150HP/175HP/215HP	FS32126-328-99	361	380*237.5*93	-
	250HP/300HP/375HP				

B. Zero-phase noise filter (EMI SUPPESION ZERO CORE)

- Part Number: 4H000D0250001
- Choose the appropriate zero-phase noise filter based on different horsepower and wire size of wiring.
- The high attenuation characteristic of zero-phase noise filter (in the amplitude modulation range from 100KHz to 50MHz, there is very high attenuation, as shown in the following figure), can be used to suppress effectively the radiation interference to external generated by the inverter.
- Zero-phase noise filter can be used either at the inverter input or output side. Wires for each phase can be winded in the same direction in application. The more the number of winding lap is, the better the performance is. If the wire diameter is too big, which results in winding failure, the wires for each phase can run through directly in the same direction, connecting several zero-phase noise filters in series at the same time.
- Attenuation characteristic (at 10 laps)

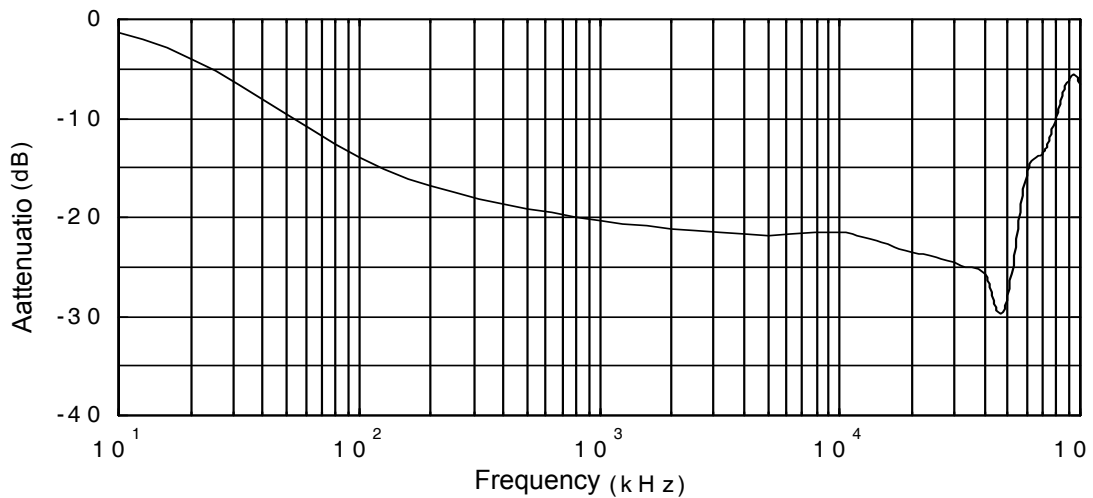

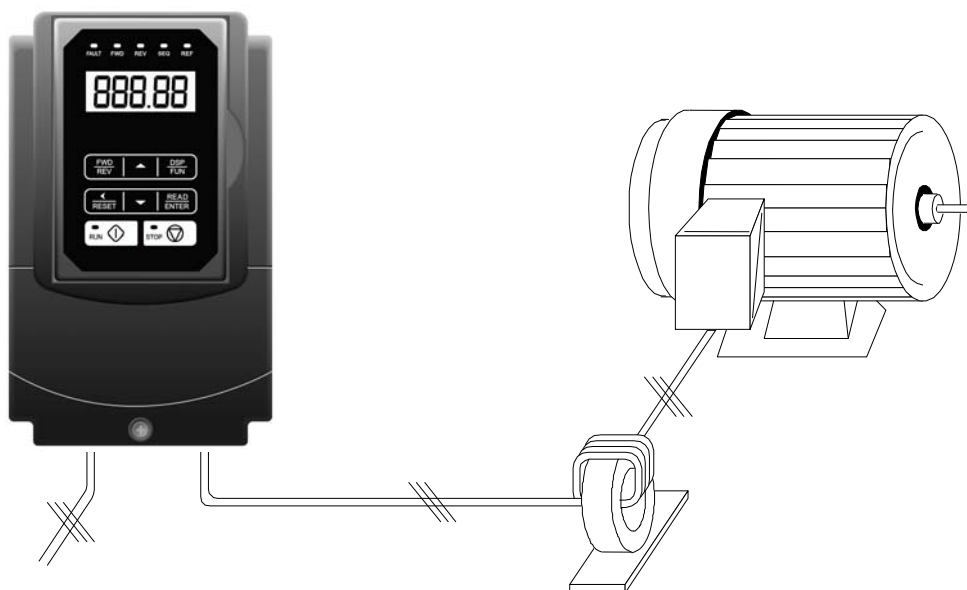

•

## Example of application



Note: It has effect that three wires of U,V,W need to through the same ZERO CORE in the same direction.

## 6.5 Output filter specification

Filter selection table  Filter	Rated current	Rated current	Typical	Nominal	Nominal	Capacitance	Min.	Typical	Input/Output connections		Weight  [Kg]
	@45°C / 50Hz  [A]	@45°C / 100Hz  [A]	motor drive rating  [kW]	inductance  [mH]	capacitance  [μF]	connection	switching frequency  [kHz]	power loss  [W]			
FN 5040-4.5-82	4.5	4.05	1.1/1.5	13	2.2	Y	4	65	-82		3.3
FN 5040-8-82	8	7.2	2.2/3	6.9	4.7	Y	4	80	-82		4.6
FN 5040-10-83	10	9	4	5.2	6.8	Y	4	90	-83		6.1
FN 5040-17-83	17	15.3	5.5/75.5	3.1	10	Y	4	115	-83		7.58
FN 5040-24-84	24	21.6	11	2.4	10	Y	4	150	-84		14.4
FN 5040-38-84	38	34.2	15/18.5	1.6	10	Y	4	170	-84		25
FN 5040-48-85	48	43.2	22	1.1	14.7	Y	4	260	-85		33
FN 5040-62-85	62	55.8	30	0.85	30	Y	3	280	-85		36
FN 5040-75-87	75	67.5	37	0.75	30	Y	3	330	-87		42
FN 5040-115-87	115	103.5	45/55	0.5	20	△	3	500	-87		68
FN 5040-180-99	180	162	75/90	0.3	33	△	3	680		-99	86
FN 5040-260-99	260	234	110/132	0.2	47	△	3	880		-99	125
FN 5040-410-99	410	369	160/200	0.13	66	△	3	1100		-99	184
FN 5040-480-99	480	432	250	0.11	94	△	3	1350		-99	235
FN 5040-660-99	660	594	315/355	0.14	141	△	2	2000		-99	310
FN 5040-750-99	750	675	400	0.12	165	△	2	2800		-99	470
FN 5040-880-99	880	792	450/500	0.11	188	△	2	3400		-99	640
FN 5040-1200-99	1200	1080	560/630	0.075	282	△	2	3800		-99	680
FN 5045-4.5-44	4.5	4.05	1.1/1.5	13	2.2	Y	4	65	-44		4.1
FN 5045-8-44	8	7.2	2.2/3	6.9	4.7	Y	4	80	-44		5.4
FN 5045-10-44	10	9	4	5.2	6.8	Y	4	90	-44		6.9
FN 5045-17-33	17	15.3	5.5/7.5	3.1	10	Y	4	115	-33		9
FN 5045-24-33	24	21.6	11	2.4	10	Y	4	150	-33		15.6
FN 5045-38-33	38	34.2	15/18.5	1.6	10	Y	4	170	-33		18.9
FN 5045-48-34	48	43.2	22	1.1	14.7	Y	4	260	-34		35.8
FN 5045-62-34	62	55.8	30	0.85	30	Y	3	280	-34		37.8
FN 5045-75-35	75	67.5	37	0.75	30	Y	3	330	-35		60
FN 5045-115-35	115	103.5	45/55	0.5	20	△	3	500	-35		70
FN 5048-180-99	180	162	75/90	0.3	33	△	3	680		-99	92
FN 5045-260-99	260	234	110/132	0.2	47	△	3	880		-99	131
FN 5045-410-99	410	369	160/200	0.13	66	△	3	1100		-99	198
FN 5045-480-99	480	432	250	0.11	94	△	3	1350		-99	243
FN 5045-660-99	660	594	315/355	0.14	141	△	2	2000		-99	425
FN 5045-750-99	750	675	400	0.12	162	△	2	2800		-99	482
FN 5045-880-99	880	792	450/500	0.11	188	△	2	3400		-99	652
FN 5045-1200-99	1200	1080	560/630	0.075	282	△	2	3800		-99	692



## 6.6 Input power side Fuse specification 220V class

Model	Horse power	KVA	100% of rated output current HD/ND	3 phases Rated input current HD/ND	three-phase fuse rating	Single-phase rated input current HD/ND
A510-2001-H	1	1.9	5/6	5.4/6.5	12	9.4/11.3
A510-2002-H	2	3	8/9.6	8.5/10.3	15	14.7/17.9
A510-2003-H	3	4.2	11/12	11.7/12.8	20	20.3/22.1
A510-2005-H3	5	6.7	17.5/21	18.7/22.3	30	X
A510-2008-H3	7.5	9.5	25/30	26.3/31.6	50	X
A510-2010-H3	10	12.6	33/40	34.5/41.7	60	X
A510-2015-H3	15	17.9	47/56	51.1/60.9	100	X
A510-2020-H3	20	22.9	60/69	65.2/75	125	X
A510-2025-H3	25	28.6	73/79	79.4/85.9	125	X
A510-2030-H3	30	32.4	85/110	92.4/119.6	150	X
A510-2040-H3	40	43.8	115/138	125/150	200	X
A510-2050-H3	50	55.3	145/169	186	250	X
A510-2060-H3	60	68.6	180/200	232	300	X
A510-2075-H3	75	81.9	215/250	275	350	X
A510-2100-H3	100	108	283/312	343	450	X
A510-2125-H3	125		346/360			
A510-2150-H3	150		415/450			

## 440V class

Model	Horse power	KVA	100% of rated output current HD/ND	Rated input current HD/ND	Fuse rating
A510-4001-H3(F)	1	2.6	3.4/4.1	3.7/4.5	6
A510-4002-H3(F)	2	3.2	4.2/5.4	4.6/5.9	10
A510-4003-H3(F)	3	4.2	5.5/6.9	6.0/7.5	10
A510-4005-H3(F)	5	7	9.2/11.1	9.6/11.6	20
A510-4008-H3(F)	7.5	11.3	14.8/17.5	15.5/18.2	25
A510-4010-H3(F)	10	13.7	18/23	18.7/24.0	30
A510-4015-H3(F)	15	18.3	24/31	25.0/32.3	50
A510-4020-H3(F)	20	23.6	31/38	33.7/41.3	60
A510-4025-H3(F)	25	29.7	39/44	42.4/47.8	70
A510-4030-H3(F)	30	34.3	45/58	48.9/63.0	80
A510-4040-H3(F)	40	45.7	60/72	65.2/78.3	100
A510-4050-H3(F)	50	57.2	75/88	81.5/95.7	125
A510-4060-H3(F)	60	69.3	91/103	98.9/112	150
A510-4075-H3	75	85.4	118/145	141	200
A510-4100-H3	100	114	150/165	181	250
A510-4125-H3	125	137	180/208	229	300
A510-4150-H3	150	165	216/250	275	350
A510-4175-H3	175	198	260/296	325	400
A510-4215-H3	215	225	295/328	360	450
A510-4250-H3	250	270	370/414		
A510-4300-H3	300	317	450/515		
A510-4375-H3	375	400	523/600		

Fuse type: Please choose the semiconductor fuse comply with UL design.  
 Class CC,J,T,RK1 or RK5  
 Voltage Range: For 220V-class inverter, please use the fuse of 300V class  
 For 440V -class inverter, please use the fuse of 00V class

## 6.7 PG speed feedback card

The key point of the option card installation, please refer to the instruction manual of each purchased card.

A. JN5-PG-O speed feedback card: Open collector speed feedback card:

### . JN5-PG-O terminal specification

Terminal Name	Description
Vcc	JN5-PG-O Card output power ; 12V/5V±5% , 200mA(voltage is selected by the SW1)
GND	Power and signal reference point
A, A\, B, B\, Z, Z\	Encoder input signal, A correct divider ratio output requires a two-phase input. Open collector input type
AO, AO\, BO, BO\, ZO, ZO\	A ,B phase divider ratio ouput, z phase output monitor, Open collector output type, 24V, 200mA
E	Ground terminal

### . JN5-PG-O Wiring Example

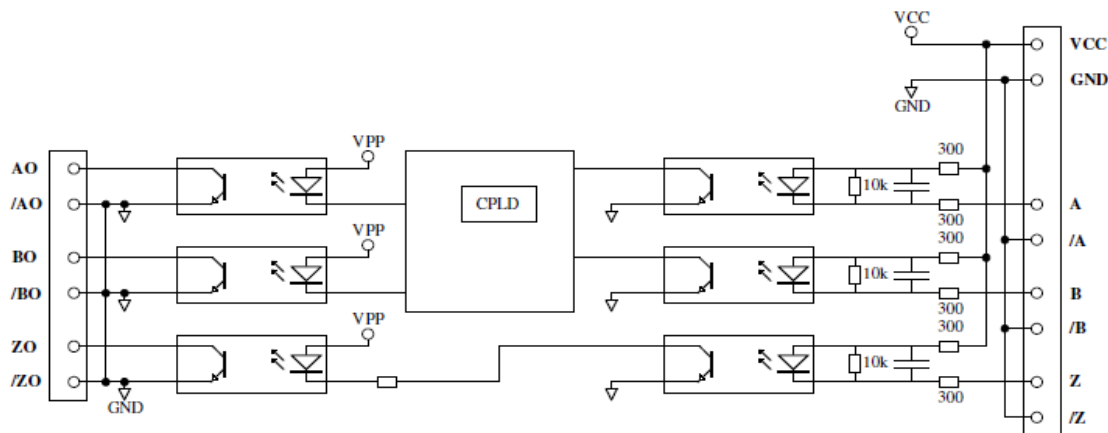

B. JN5-PG-L speed feedback card: Line driver speed feedback card:

. JN5-PG-L terminal specification

Terminal Name	Description
Vcc	JN5-PG-L Card output power; 12V/5V±5% ,200mA(voltage is selected by the SW1 )
GND	Power and signal reference point
A, A\, B, B\, Z, Z\	Encoder input signal, A correct divider ratio output requires a two-phase input. line driver input type, RS-422 level input
AO, AO\, BO, BO\, ZO, ZO\	A, B phase divider ratio output, z phase output monitor, line driver output type, RS-422 level output
E	Ground terminal

. JN5-PG-L wiring example

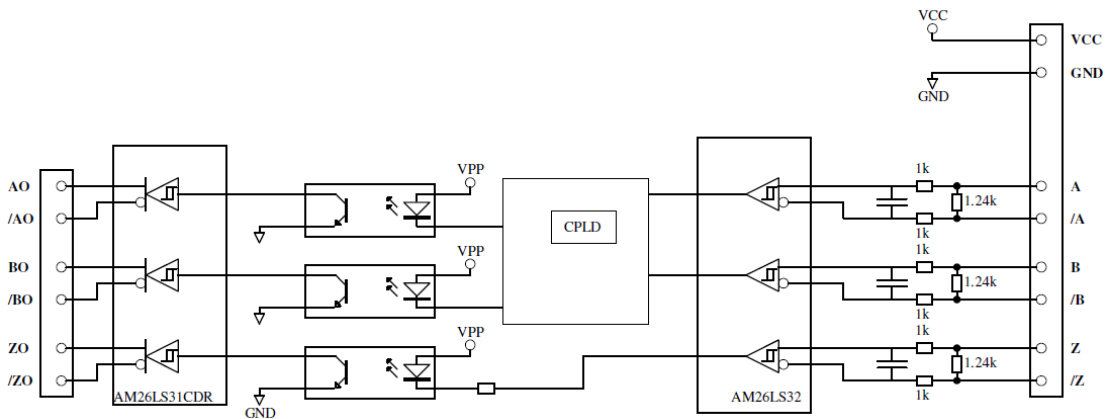

C. JN5-PG-PM speed feedback card : synchronous motor line driver speed feedback card :

. JN5-PG-PM terminal specification

Terminal Name	Description
Vcc	JN5-PG-PM Card output power; 5V±5% ,200mA
GND	Power and signal reference point
A, A\, B, B\, Z, Z\ U, U\, V, V\, Z, Z\	Encoder input signal, A correct divider ratio output requires a two-phase input. line driver input type, RS-422 level input
AO, AO\, BO, BO\, ZO, ZO\	A ,B phase divider ratio output, z phase output monitor, line driver output type, RS-422 level output
E	Ground terminal

. JN5-PG-PM wiring example

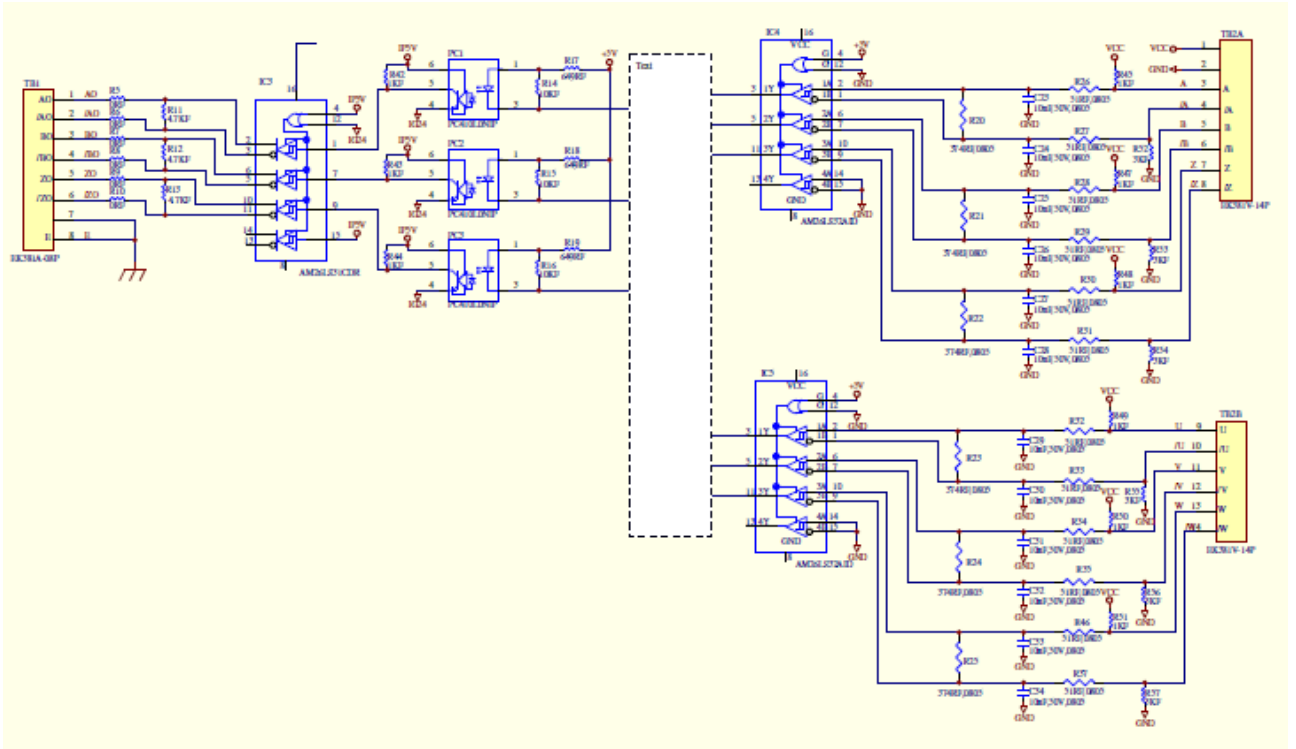

## 6.8 Other

### A. JN5-OP-A02 LCD digital operator

- For A510, addition to the standard LED digital operator, you can also buy LCD digital operator (as below figure). Its wiring with the inverter is shown as following:



## B. Analog Operator

- For A510, in addition to the standard LED digital operator and optional LCD digital operator, an analog pointer operation panel JNEP-16 can be installed (as below figure), pull-out type removable operation panel. Its wiring with the inverter is shown as following:

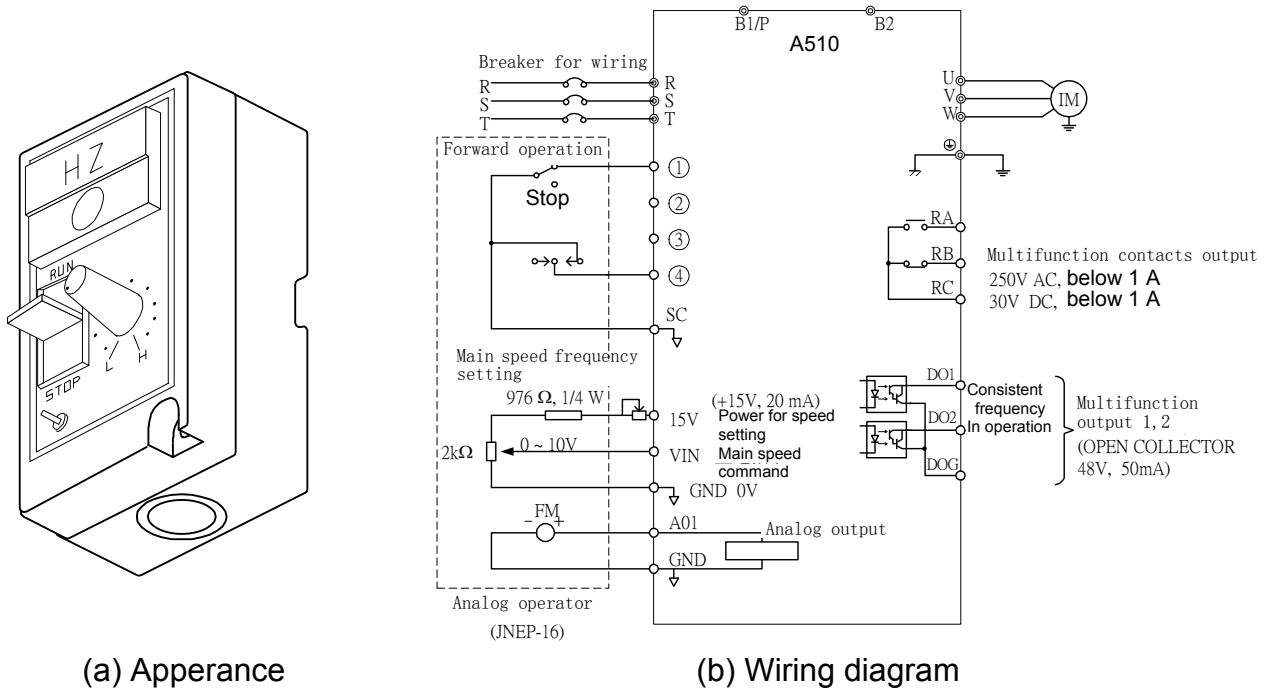

Figure 9 Analog operation panel

- LED digital operator can be pulled out for operation. The extension wire with different specification can be chosen according to the requirement.



L	Extension wire *1
1m	JN5-CB-01M
2m	JN5-CB-02M
3m	JN5-CB-03M
5m	JN5-CB-05M

- \* 1: with special isolated wired extension wire, blank operation box, mounting screws and instructions.
- \* 2: with a piece of special isolated wired extension wire.
- \* 3: blank operation box is used to mount on the original position of the digital operator, to prevent falling foreign objects and increase the aesthetic.

Installation dimensions of LED digital operator is shown as below:

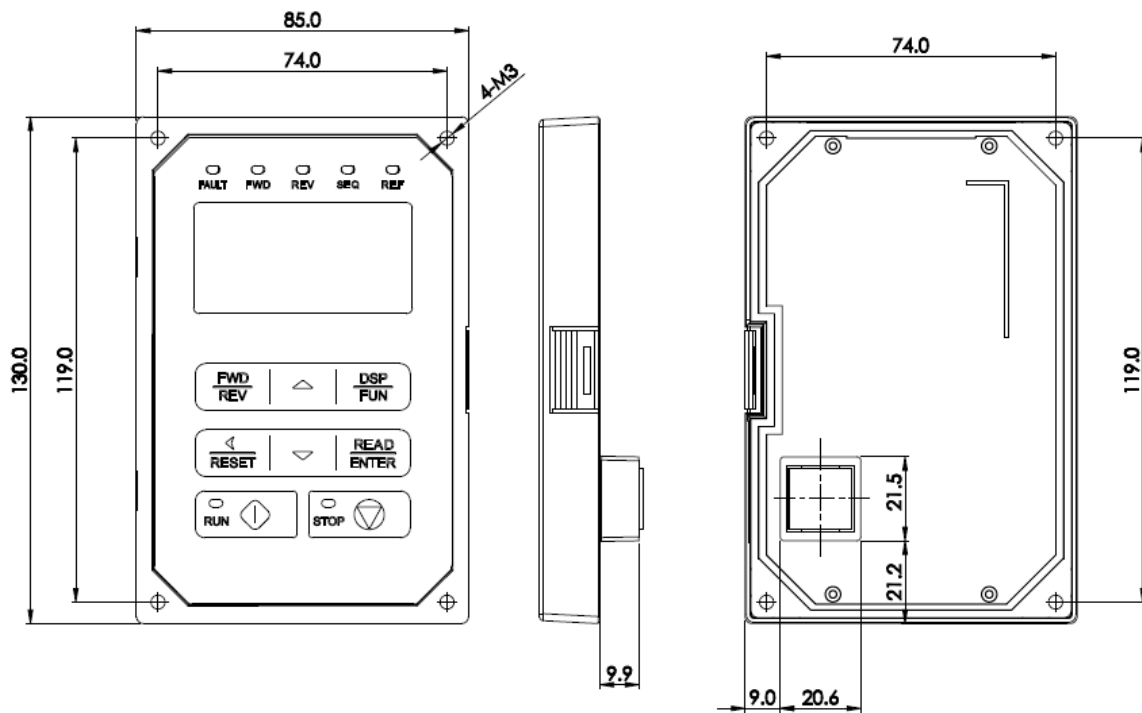

Figure 8 LED digital operator dimensions

## 6.9 Communication Interface Module (in development)

### (a) PROFIBUS communication interface module (JN5-CM-PDP)

- For wire example, please refer to 「JN5-CM-PDP communication function application manual」 for communication procedure planning method.

### (b) DEVICENET communication interface module (JN5-CM-DNET)

- For wire example, please refer to 「JN5-CM-DNET communication function application manual」 for communication procedure planning method.

### (c) CANopen communication interface module (JN5-CM-DNET)

- For wire example, please refer to 「JN5-CM-CAN communication function application manual」 for communication procedure planning method.

### (d) TCP-IP communication interface module (JN5-CM-TCPIP)

- For wire example, please refer to 「JN5-CM-TCPIP communication function application manual」 for communication procedure planning method.

# Appendix

## A. Example of RS-485 communication interface wiring

- A510 RS-485 port (RJ45) adopts MODBUS protocol to communicate with outside. If the external PROFIBUS (JN5-CM-PDP) / Devicenet module (JN5-CM-DNET) is added in, then PROFIBUS-DP/Devicenet communication protocol can be used to communicate with outside.
- System application wiring of MODBUS and PROFIBUS-DP communications, as following:

### a. Wiring example of MODBUS communication protocol

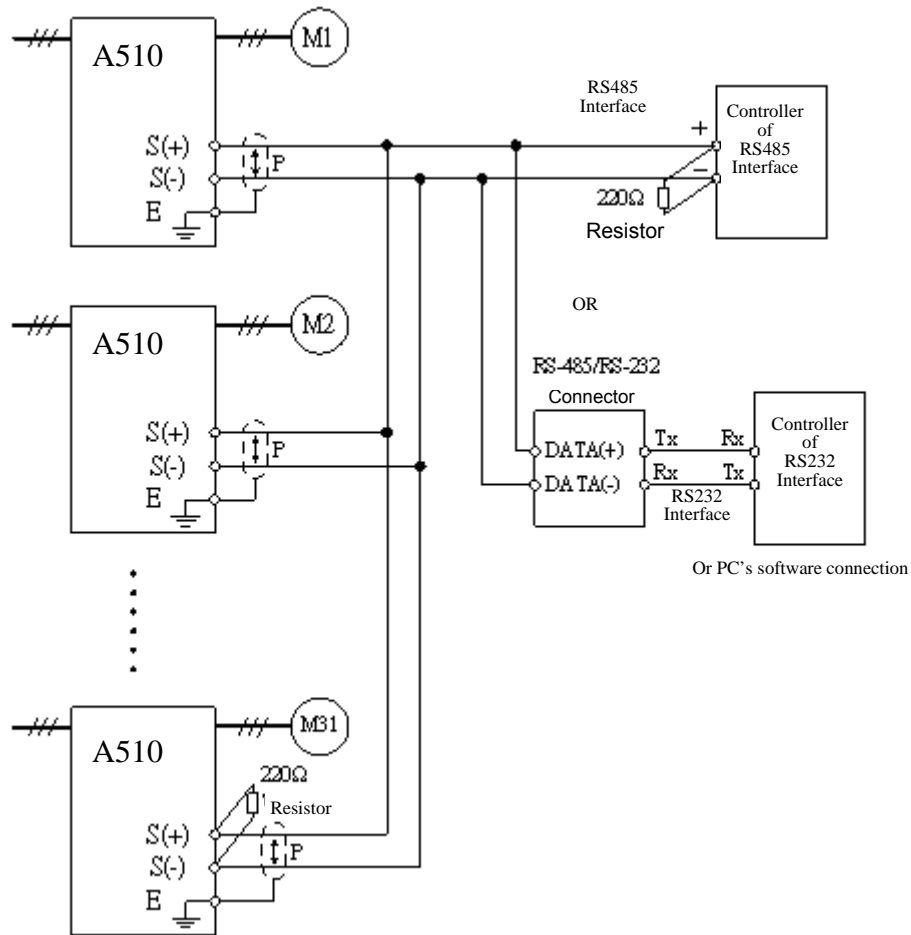

Figure 52 Wiring figure of MODBUS communication protocol

Note: 1. If the host controller has RS-485 interface, it can be connected directly to the RS-485 communication interface of A510. But if the host controller does not have RS-485 interface and only has RS-232 interface (such as PC connection), it can be connected to the RS-485 COM port of A510 through adapter of RS-485/RS-232.

2. When MODBUS communication protocol is used to communicate with outside, no more than 31 inverters can be connected in parallel. If multiple inverters are connected, a resistor of  $220\Omega$  must be connected to both sides of the RS-485 COM port of the last inverter.
3. Please refer to "A510 RS-485 MODBUS communication function application manual."

b. Wiring example of PROFIBUS communication protocol

- A PROFIBUS model (JN5-CM-PDP) requires to be added for the communication of PROFIBUS-DP.

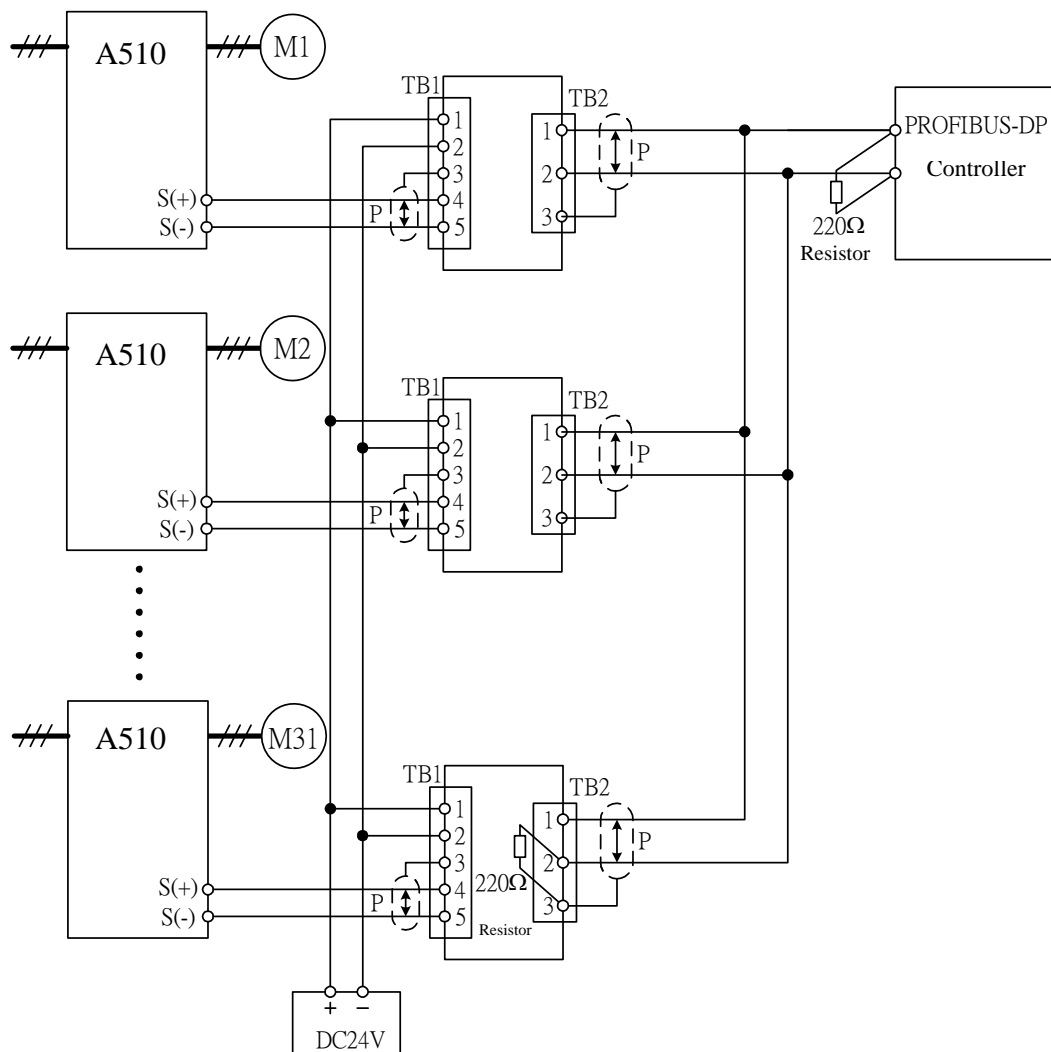

Figure 53 Wiring example of PROFIBUS communication protocol

Note: 1. For the power consumption of each PROFIBUS / Devicenet module, the power supply with appropriate capacity should be selected according to the



sets of inverter in parallel connection.

2. When PROFIBUS / Devicenet module is used for communication, just 31 inverters of maximum can be connected in parallel. If multiple inverters are connected, a resistor of  $220\Omega$  must be connected to both sides of the RS-485 COM port of the last inverter.
3. Please refer to "A510 PROFIBUS-DP communication function application manual."

## B. SINK/SOURCE terminal interface wiring example

- The terminals ①~⑧ of UL/CUL models (JNTMBGGB□□□□JK/AZ□U□) can be set to SINK or SOURCE interface.
  - a. SINK interface wiring example: SW3 jumper is placed in SINK position.
    - Use transistor (open collector type) to be the standard wiring of operation signal:

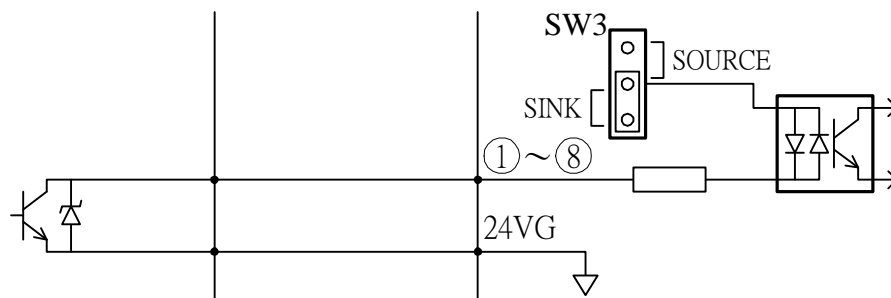

- Use NPN type (SINK) detector to be the standard wiring of operation signal:

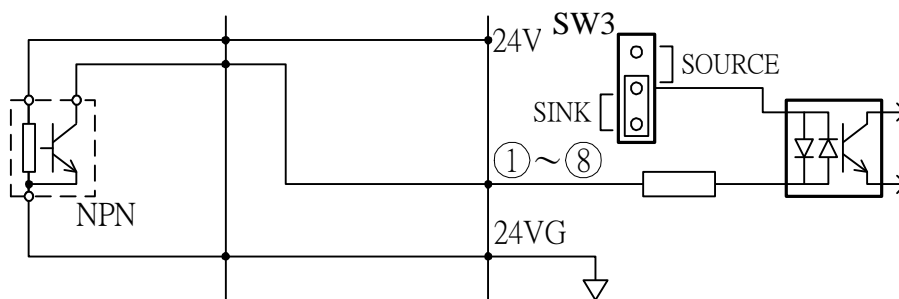

b. SOURCE interface wiring example: SW3 jumper is placed in SOURCE position.

- Use transistor (open collector type) to be the standard wiring of operation signal:

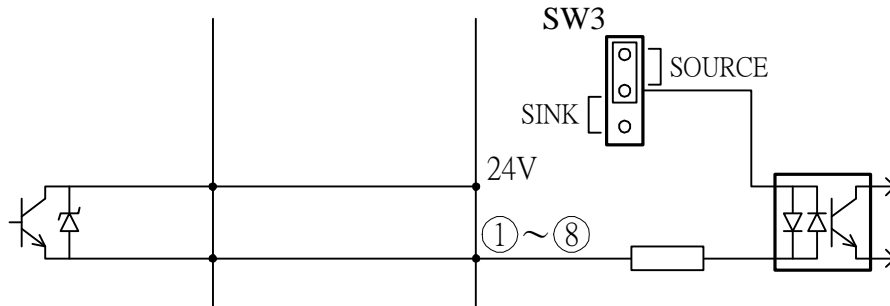

- Use PNP type (SOURCE) detector to be the standard wiring of operation signal:

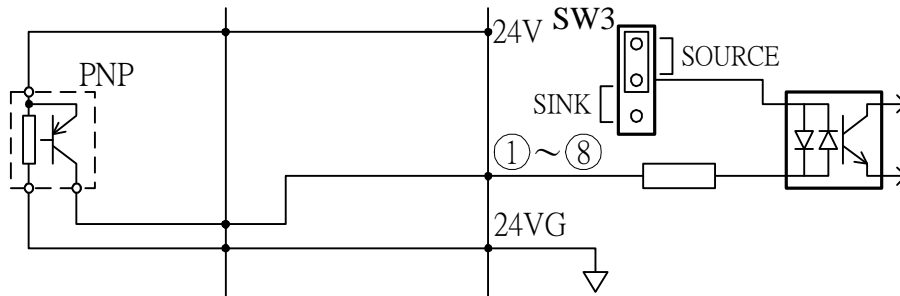

## Appendix-1 Instructions for UL

### ◆ Safety Precautions

#### DANGER

##### Electrical Shock Hazard

**Do not connect or disconnect wiring while the power is on.**  
Failure to comply will result in death or serious injury.

#### WARNING

##### Electrical Shock Hazard

**Do not operate equipment with covers removed.**

Failure to comply could result in death or serious injury.

The diagrams in this section may show drives without covers or safety shields to show details. Be sure to reinstall covers or shields before operating the drives and run the drives according to the instructions described in this manual.

**Always ground the motor-side grounding terminal.**

Improper equipment grounding could result in death or serious injury by contacting the motor case.

**Do not touch any terminals before the capacitors have fully discharged.**

Failure to comply could result in death or serious injury.

Before wiring terminals, disconnect all power to the equipment. The internal capacitor remains charged even after the power supply is turned off. After shutting off the power, wait for at least the amount of time specified on the drive before touching any components.

**Do not allow unqualified personnel to perform work on the drive.**

Failure to comply could result in death or serious injury.

Installation, maintenance, inspection, and servicing must be performed only by authorized personnel familiar with installation, adjustment, and maintenance of AC drives.

**Do not perform work on the drive while wearing loose clothing, jewelry, or lack of eye protection.**

Failure to comply could result in death or serious injury.

Remove all metal objects such as watches and rings, secure loose clothing, and wear eye protection before beginning work on the drive.

**Do not remove covers or touch circuit boards while the power is on.**

Failure to comply could result in death or serious injury.

##### Fire Hazard

**Tighten all terminal screws to the specified tightening torque.**

Loose electrical connections could result in death or serious injury by fire due to overheating of electrical connections.

**Do not use an improper voltage source.**

Failure to comply could result in death or serious injury by fire.

Verify that the rated voltage of the drive matches the voltage of the incoming power supply before applying power.

**Do not use improper combustible materials.**

Failure to comply could result in death or serious injury by fire.

Attach the drive to metal or other noncombustible material.

#### NOTICE

**Observe proper electrostatic discharge procedures (ESD) when handling the drive and circuit boards.**

Failure to comply may result in ESD damage to the drive circuitry.

**Never connect or disconnect the motor from the drive while the drive is outputting voltage.**

Improper equipment sequencing could result in damage to the drive.

**Do not use unshielded cable for control wiring.**

Failure to comply may cause electrical interference resulting in poor system performance. Use shielded twisted-pair wires and ground the shield to the ground terminal of the drive.

## Appendix-1 Instructions for UL

### NOTICE

**Do not modify the drive circuitry.**

Failure to comply could result in damage to the drive and will void warranty.

Yaskawa is not responsible for any modification of the product made by the user. This product must not be modified.

**Check all the wiring to ensure that all connections are correct after installing the drive and connecting any other devices.**

Failure to comply could result in damage to the drive.

#### ◆ UL Standards

The UL/cUL mark applies to products in the United States and Canada and it means that UL has performed product testing and evaluation and determined that their stringent standards for product safety have been met. For a product to receive UL certification, all components inside that product must also receive UL certification.



#### ◆ UL Standards Compliance

This drive is tested in accordance with UL standard UL508C and complies with UL requirements. To ensure continued compliance when using this drive in combination with other equipment, meet the following conditions:

##### ■ Installation Area

Do not install the drive to an area greater than pollution severity 2 (UL standard).

##### ■ Main Circuit Terminal Wiring

UL approval requires crimp terminals when wiring the drive's main circuit terminals. Use crimping tools as specified by the crimp terminal manufacturer. Teco recommends crimp terminals made by NICHIFU for the insulation cap.

The table below matches drives models with crimp terminals and insulation caps. Orders can be placed with a Teco representative or directly with the Teco sales department.

Closed-Loop Crimp Terminal Size

Drive Model A510	Wire Gauge mm <sup>2</sup> , (AWG)		Terminal Screws	Crimp Terminal Model No.	Tool Machine No.	Insulation Cap Model No.
	R/L1 · S/L2 · T/L3	U/T1 · V/T2 · W/T3				
2002	2 (14)		M4	R2-4	Nichifu NH 1 / 9	TIC 2
	3.5 (12)			R5.5-4		TIC 3.5
	5.5 (10)					TIC 5.5
2005	5.5 (10)		M4	R5.5-4	Nichifu NH 1 / 9	TIC 5.5
2010	8 (8)		M4	R8-4	Nichifu NOP 60	TIC 8
2025	22 (4)		M6	R22-6	Nichifu NOP 60 / 150H	TIC 22
2040	60 (1/0)		M8	R60-8	Nichifu NOP 60 / 150H	TIC 60
2060	100 (4/0)		M10	R80-10	Nichifu NOP 150H	TIC 80
2100	200 (4/0)*2		M10	R100-10	Nichifu NOP 150H	TIC 100
4003	2 (14)		M4	R2-4	Nichifu NH 1 / 9	TIC 2
	3.5 (12)			R5.5-4		TIC 3.5
	5.5 (10)					TIC 5.5
4008	3.5 (12)		M4	R5.5-4	Nichifu NH 1 / 9	TIC 3.5
	5.5 (10)					
4015	8 (8)		M4	R8-4	Nichifu NOP 60	TIC 8
4030	14 (6)		M6	R14-6	Nichifu NOP 60 / 150H	TIC 14
4060	38 (2)		M8	R38-8	Nichifu NOP 60 / 150H	TIC 38
4100	80 (3/0)		M10	R80-10	Nichifu NOP 150H	TIC 80
4215	200 (4/0)*2		M10	R100-10	Nichifu NOP 150H	TIC 100

Recommended Input Fuse Selection

Drive Model A510	Fuse Type	
	Manufacturer: Bussmann / FERRAZ SHAWMUT	
	Model	Fuse Ampere Rating (A)
200 V Class Three-Phase Drives		
2001	Bussmann 20CT	690V 20A
2002	Bussmann 20CT	690V 20A
2003	Bussmann 50FE	690V 50A
2005	Bussmann 50FE	690V 50A
2008	Bussmann 63FE	690V 63A
2010	FERRAZ SHAWMUT A50QS100-4	500V 100A
2015	Bussmann 120FEE / FERRAZ A50QS150-4	690V 120A / 500V 150A
2020	FERRAZ SHAWMUT A50QS150-4	500V 150A
2025	FERRAZ SHAWMUT A50QS200-4	500V 200A
2030	FERRAZ SHAWMUT A50QS250-4	500V 250A
2040	FERRAZ SHAWMUT A50QS300-4	500V 300A
2050	FERRAZ SHAWMUT A50QS400-4	500V 400A
2060	FERRAZ SHAWMUT A50QS500-4	500V 500A
2075	FERRAZ SHAWMUT A50QS600-4	500V 600A
2100	FERRAZ SHAWMUT A50QS700-4	500V 700A

Drive Model A510	Fuse Type	
	Manufacturer: Bussmann / FERRAZ SHAWMUT	
	Model	Fuse Ampere Rating (A)
400 V Class Three-Phase Drives		
4001	Bussmann 20CT	690V 20A
4002	Bussmann 16CT	690V 16A
4003	Bussmann 16CT	690V 16A
4005	Bussmann 25ET	690V 25A
4008	Bussmann 40FE	690V 40A
4010	Bussmann 50FE	690V 50A
4015	Bussmann 63FE	690V 63A
4020	Bussmann 80FE	690V 80A
4025	Bussmann 100FE / FERRAZ A50QS100-4	690V 100A / 500V 100A
4030	Bussmann 120FEE	690V 120A
4040	FERRAZ SHAWMUT A50QS150-4	500V 150A
4050	FERRAZ SHAWMUT A50QS200-4	500V 200A
4060	FERRAZ SHAWMUT A50QS250-4	500V 250A
4075	FERRAZ SHAWMUT A50QS300-4	500V 300A
4100	FERRAZ SHAWMUT A50QS400-4	500V 400A
4125	FERRAZ SHAWMUT A50QS500-4	500V 500A
4150	FERRAZ SHAWMUT A50QS600-4	500V 600A
4175	FERRAZ SHAWMUT A50QS700-4	500V 700A
4215	FERRAZ SHAWMUT A50QS700-4	500V 700A

◆ Motor Overtemperature Protection

Motor overtemperature protection shall be provided in the end use application.

■ Field Wiring Terminals

All input and output field wiring terminals not located within the motor circuit shall be marked to indicate the proper connections that are to be made to each terminal and indicate that copper conductors, rated 75°C are to be used.

■ Drive Short-Circuit Rating

This drive has undergone the UL short-circuit test, which certifies that during a short circuit in the power supply the current flow will not rise above value. Please see electrical ratings for maximum voltage and table below for current.

- The MCCB and breaker protection and fuse ratings (refer to the preceding table) shall be equal to or greater than the short-circuit tolerance of the power supply being used.
- Suitable for use on a circuit capable of delivering not more than (A) RMS symmetrical amperes for (Hp) Hp in 240 / 480 V class drives motor overload protection.

Horse Power ( Hp )	Current ( A )	Voltage ( V )
1 - 50	5,000	240 / 480
51 - 200	10,000	240 / 480
201 - 400	18,000	240 / 480
401 - 600	30,000	240 / 480

**Appendix-1 Instructions for UL**

**◆ Drive Motor Overload Protection**

Set parameter 02-01 (motor rated current) to the appropriate value to enable motor overload protection. The internal motor overload protection is UL listed and in accordance with the NEC and CEC.

**■ 02-01 Motor Rated Current**

Setting Range: Model Dependent  
 Factory Default: Model Dependent

The motor rated current parameter (02-01) protects the motor and allows for proper vector control when using open loop vector or flux vector control methods (00-00 = 2 or 3). The motor protection parameter 08-05 is set as factory default. Set 02-01 to the full load amps (FLA) stamped on the nameplate of the motor.

The operator must enter the rated current of the motor (17-02) in the menu during auto-tuning. If the auto-tuning operation completes successfully (17-00 = 0), the value entered into 17-02 will automatically write into 02-01.

**■ 08-05 Motor Overload Protection Selection**

The drive has an electronic overload protection function (OL1) based on time, output current, and output frequency, which protects the motor from overheating. The electronic thermal overload function is UL-recognized, so it does not require an external thermal overload relay for single motor operation.

This parameter selects the motor overload curve used according to the type of motor applied.

**Overload Protection Settings**

Setting	Description
---0B	Disabled
---1B	Enabled
--0-B	Motor cold start protection
--1-B	Motor hot start protection
-0-B	Standard Motor protection
-1-B	Inverter duty motor protection

Sets the motor overload protection function in G08-01 according to the applicable motor.

Setting 08-05 = ---0B. Disables the motor overload protection function when two or more motors are connected to a single inverter. Use an alternative method to provide separate overload protection for each motor such as connecting a thermal overload relay to the power line of each motor.

Setting 08-05 = --1-B. The motor overload protection function should be set to hot start protection characteristic curve when the power supply is turned on and off frequently, because the thermal values are reset each time when the power is turned off.

Setting 08-05 = -0-B. For motors without a forced cooling fan (general purpose standard motor), the heat dissipation capability is lower when in low speed operation.

Setting 08-05 = -1-B. For motors with a forced cooling fan (inverter duty or V/F motor), the heat dissipation capability is not dependent upon the rotating speed.

To protect the motor from overload by using electronic overload protection, be sure to set parameter 02-01 according to the rated current value shown on the motor nameplate.

Refer to the following "Motor Overload Protection Time" for the standard motor overload protection curve example : Setting 08-05 = -0-B.

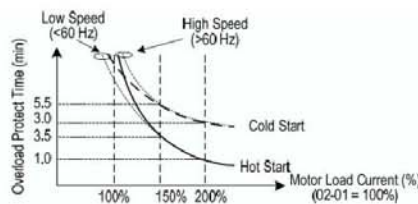

**Motor Overload Protection Time**

**■ 08-06 Motor Overload Operation Selection**

Setting	Description
0	Free Run to Stop (default setting)
1	Alarm Only



**TECO Electric & Machinery Co., Ltd.**

10F., No.3-1, Yuancyu St., Nangang District,

Taipei City 115, Taiwan

Tel : +886-2-6615-9111

Fax : +886-2-6615-0933

<http://www.teco.com.tw>

Distributor

Ver:01 2012.01

---

This manual may be modified when necessary because of improvement of the product, modification, or changes in specifications, This manual is subject to change without notice.